



- Music
- Forward



WARNING: This product must be assembled by an adult. When unassembled, there are small and sharp parts, which could be choked on if swallowed. Keep out the reach of small children.
Warning: Do not use in traffic.

IMPORTANT, RETAIN FOR FUTURE REFERENCE: READ CAREFULLY

ASSEMBLY INSTRUCTION

Dear customer,

















Thank you for purchasing this product. So that your appliance serves you well, please read all the instructions in this user's manual. If you have any questions, please contact our customer care center. Our contact details are below:

 0044-800-240-4004

 enquiries@mhstar.co.uk

IMPORTER ADDRESS:
MH STAR UK LTD
Unit 27, Perivale Park,
Horsenden lane South
Perivale, UB6 7RH
MADE IN CHINA

PARTS

 Car body A x 1	 Basket B x 1	 Buffer beam C x 1
 Wheel D x 3	 Driving wheel E x 1	 Handlebar F x 1
 Wheel cover G x 4	 M8 spanner H x 1	 Seat I x 1
 Motor J x 1	 Rear axle K x 1	 Washer L x 9
 M8 nut M x 1	 Cotter pin N x 4	 Screw O x 4
		 Charger P x 1



Product specification

Battery	6V
Suitable age	18-48 months
Loading capacity	25kg
Product size	70*42*45cm
Speed	1.0-3.0km/h
Charge/use time	Charge 8-12h, Use 45min
Charger	6V

Function

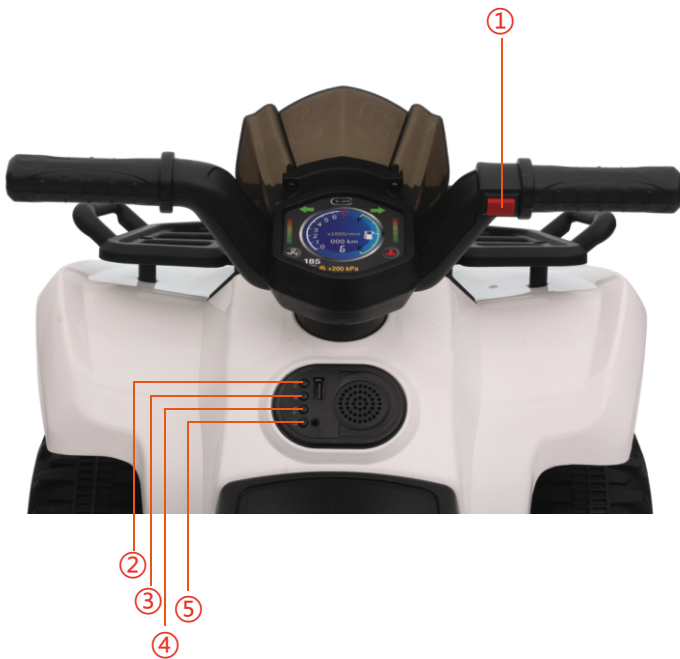

- | |
|---|
| <ul style="list-style-type: none"> ① Forward ② Music switch/Volume - ③ Pause/play ④ Music switch/Volume + ⑤ Music power switch |
|---|

Assembly installation

1. Front wheel assembly

Add 1pc washer, 1pc wheel, 1pc washer step by step, use 1pc cotter pin to tighten (bend the cotter with plier). At last, insert 1pc wheel cover into the wheel. The same assembly step for the other side.



2. Rear axle, wheel and motor assembly

Add 1pc washer to the rear axle from the long side. Turn the car body over, then insert rear axle into the car body like picture. Add 1pc motor, 1pc driving wheel, 1pc washer step by step to the left side of the rear axle, use 1pc cotter pin to tighten (bend the cotter with plier), then insert 1pc wheel cover into the wheel. Add 1pc washer, 1pc wheel, 1pc washer step by step to the right side of the rear axle, use 1pc cotter pin to tighten (bend the cotter with plier), then insert 1pc wheel cover into the wheel.

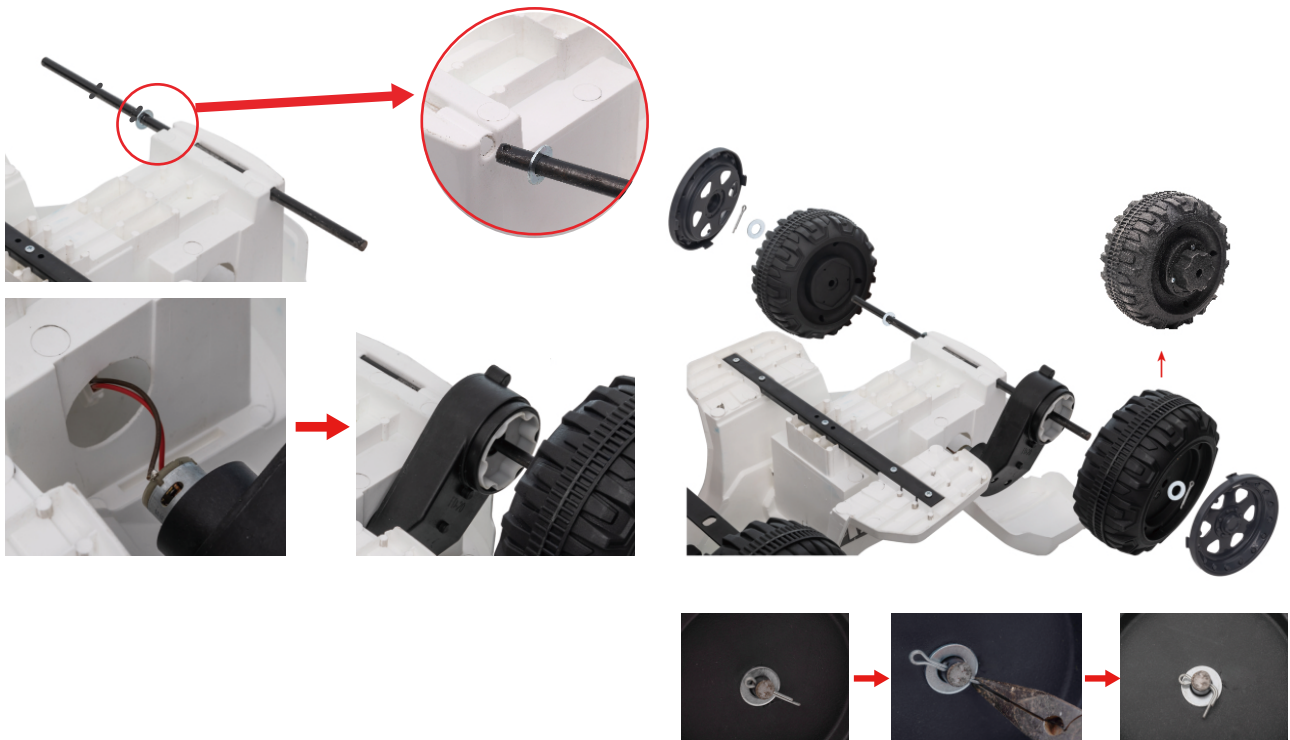

3. Handlebar assembly

Insert the handlebar into the hole on the car, then insert the direction lever into the hole on the front axle, add 1pc washer, use 1pc M8 nut to tighten. Pass the handlebar line through the hole under the seat, then connect the handlebar line and the car line.



4. Basket and buffer beam assembly

Insert the basket into the holes on the car, use 4pcs screw to tighten. Insert the buffer beam into the hole on the front bumper.



5. Connect the motor line and battery line

Connect two white connectors(motor line) like picture.
Connect two red connectors (battery line) like picture.



6. Seat assembly

Insert the seat into the car, then lock the seat.



WARNING

- For children's safety, please follow these instructions carefully.
- Adult assembly and adjustment are required, keep children away.
- Small parts are present when assembling, keep small children away to prevent choking.
- Children must wear the safety belt when riding.
- Adult supervision is always required when riding. Teach children how to ride before using.
- Never stand or play when the product is moving.
- Battery to be charged by adults only. Fully charge the product before first use.
- Keep children away from plastic packaging to prevent suffocation.
- Only use spare parts that are provided by the manufacturer.
- The charger is not a toy and shouldn't be played with.
- Maximum load: 25kg. Do not overload.
- Suitable age: 18-48 months.

Safety use

- Do not use in the street, on the road or near slopes and ditches.
- Do not change the wire or add electrical devices to the car.
- Use in a dry area, keeping away from wet conditions. Keep away from open flames.
- Suitable for 1 children. Do not overload.
- Maximum capacity is 25kg.
- When not in use, switch off the power. If not in use for a long period, unplug the battery.
- Check battery, charger and other parts regularly. If damages are found, ensure they are fixed before using.

Charging notification

- Before the first use, charge for 10 hours.
- Place the charger into the hole under the seat, then plug the charger into the socket.
- The car cannot be used when charging.
- Do not charge for more than 12 hours.
- When charging, it is normal for the battery and charger to be warm.
- Do not charge if the plug is wet to avoid electrical hazards or a short circuit.
- Only use the charger provided by the manufacturer. Any other charger can damage the battery or cause a short circuit.
- If not in use for a long period, ensure it gets charged once a month.

Charging steps are as follows:

Step 1: The charging hole is under the seat.

Step 2: Put the charger plug into the hole.

Step 3: Connect the charger to a power socket.

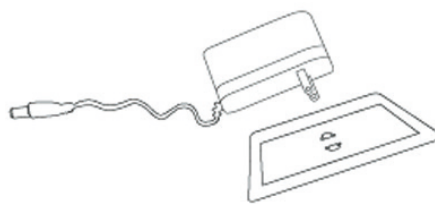

Warning: Car must be charged by an adult. This product cannot be used when charging.

Problem solution

Problem	Analysis	Solution
Car can not move	Battery low power	Charge battery
	Fuse protect	Reuse a few minutes later
	Power not turn on	Turn on it again
	Battery line loose	Reconnect
	Battery damaged	Replace a new one
	Electric device damaged	Replace a new one
Battery can not be recharged	Motor damaged	Replace a new one
	Battery connector loose	Reconnect
	Charger not plug in	Replug
Car does not run very long	Charger damages	Replace a new one
	Battery power low	Recharge
Charger feels warm when charging	Battery is old	Replace a new one
	Chemical reaction	Normal
Speed slow	Battery power low	Recharge
	Overloaded	Reduce weight under 25KG
	Road is not even	Play in a smooth area

Maintenance and Service

- Check battery, charger and other parts regularly. If there are any damages, ensure it is fixed before using.
- Use lubricating oil for parts. Keep this product away from open flames and out of direct sunlight.
- Store indoors and use a water-resistant cover.
- Keep away from flammable materials to avoid fire hazards.
- Charge the product after each use.
- Clean with a dry cloth. Do not use chemical solvents to wipe plastic parts. Do not wash with water. Do not use when raining or snowing – water can damage the motor, electric system or battery.
- Switch off the power after each use.
- Only use the charger provided by the manufacturer.
- Do not modify this car or its electric wire in any way.



- Musique
- Marche avant



AVERTISSEMENT : Ce produit doit être assemblé par un adulte. À l'état non assemblé, il présente des pièces de petite taille et tranchantes, qui risquent de provoquer un étouffement en cas d'ingestion. Tenez-le hors de portée des jeunes enfants.

Avertissement : À ne pas utiliser dans la circulation.

IMPORTANT : A LIRE ATTENTIVEMENT ET À CONSERVER POUR CONSULTATION ULTÉRIEURE.

INSTRUCTIONS DE MONTAGE

Cher client,

Nous vous remercions d'avoir acheté ce produit. Afin que vous puissiez profiter pleinement de votre appareil, veuillez lire toutes les instructions de ce manuel d'utilisation. Si vous avez la moindre question, veuillez contacter notre centre d'assistance à la clientèle.

Nos coordonnées sont les suivantes:



0033-1-84166106



aosom@mhfrance.fr

Importé par :

MH France

2, rue Maurice Hartmann

92130 Issy-les-Moulineaux

France

Fabriqué en Chine

PARTS



A x 1

Carrosserie



B x 1

Basket



C x 1

Poutre tampon



D x 3

Roue



E x 1

Roue motrice



F x 1

Guidon



G x 4

Enjoliveur de roue



H x 1

Clé M8



I x 1

Siège



J x 1

Moteur



K x 1

Essieu arrière



L x 9

Rondelle



M x 1

Écrou M8



N x 4

Goupille



O x 4

Vis



P x 1

Chargeur



Spécification du produit

Batterie	6V
Age approprié	18-48 mois
Capacité de charge	25kg
Taille du produit	70*42*45cm
Vitesse	1.0-3.0km/h
Temps de charge/d'utilisation	Charger 8- 12h, Utilisation 45Min
Charge	6V

Function

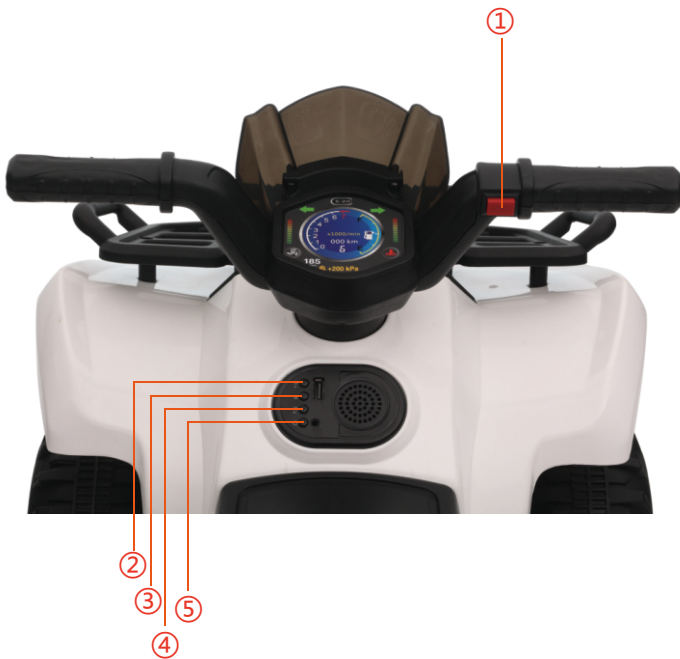

- ① Marche avant
- ② Commutateur de musique / Volume -
- ③ Pause/lecture
- ④ Commutateur de musique / Volume +
- ⑤ Interrupteur d'alimentation de musique

Assemblage

1. Assemblage de la roue avant

Mettez 1 rondelle, 1 roue, 1 rondelle étape par étape, serrez -le avec 1 goupille fendue (pliez la goupille avec une pince). Enfin, insérez 1 enjoliveur dans la roue. La même étape d'assemblage pour l'autre côté.



2. Assemblage de l'essieu arrière de la roue du moteur

Mettez 1 rondelle à l'essieu arrière du côté long. Retournez la carrosserie, puis insérez l'essieu arrière dans la carrosserie comme montré sur la figure. Mettez 1 moteur, 1 roue motrice, 1 rondelle étape par étape sur le côté gauche de l'essieu arrière, serrez-le avec 1 goupille fendue (pliez la goupille avec une pince), puis insérez 1 enjoliveur dans la roue. Mettez 1 rondelle, 1 roue, 1 rondelle étape par étape sur le côté droit de l'essieu arrière, serrez-le avec 1 goupille fendue (plier la goupille avec une pince), puis insérez 1 enjoliveur de roue dans la roue.



3. Assemblage du guidon

Insérez le guidon dans le trou de la voiture, puis insérez le levier de direction dans le trou de l'essieu avant, mettez 1 rondelle, serrez-le à l'aide de 1 écrou M8. Passez le fil du guidon dans le trou sous le siège, puis connectez la ligne du guidon et le fil de la voiture.



4. Assemblage du panier et de la poutre tampon

Insérez le panier dans les trous de la voiture, serrez-le avec 4 vis. Insérez la poutre tampon dans le trou du pare-chocs avant.



5. Connexion du fil du moteur et du fil de la batterie

Connectez deux connecteurs blancs (fil de moteur) comme montré dans la figure.

Connectez deux connecteurs rouges (fil de batterie) comme montré dans la figure.

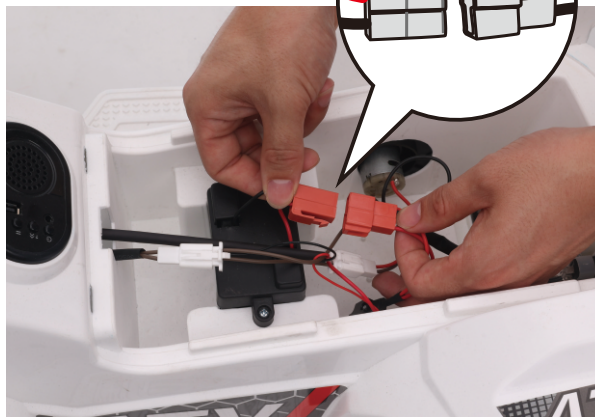

6. Assemblage du siège

Insérez le siège dans la voiture, puis verrouillez le siège.



AVERTISSEMENT

- Pour la sécurité des enfants, veuillez suivre attentivement ces instructions.
- L'assemblage et le réglage doivent être effectués par un adulte, tenez les enfants à l'écart.
- De petites pièces sont utilisées lors de l'assemblage, éloignez les jeunes enfants pour éviter tout risque d'étouffement.
- Les enfants doivent porter la ceinture de sécurité lors de la conduite.
- La surveillance d'un adulte est toujours requise pendant la conduite. Apprenez aux enfants à rouler avant de les laisser utiliser le produit.
- Ne vous tenez jamais debout et ne jouez jamais lorsque le produit est en mouvement.
- La batterie ne doit être chargée que par des adultes. Chargez complètement le produit avant la première utilisation.
- Tenez les enfants à l'écart des emballages en plastique pour prévenir la suffocation.
- N'utilisez que les pièces détachées fournies par le fabricant.
- Ne pas jouer avec le chargeur
- Charge maximale : 25kg. Ne pas dépasser la charge maximale autorisée
- Âge recommandé : 18-48 mois.

Consignes de sécurité

- Ne pas utiliser dans la rue, sur la route ou près des pentes et des fossés.
- Ne pas changer le fil ou ajouter des dispositifs électriques à la voiture.
- Utiliser dans un endroit sec, à l'écart des conditions humides. Tenir à l'écart des flammes nues.
- Convient pour 1 enfants. Ne pas surcharger.
- La capacité maximale est de 25 kg.
- Lorsque vous n'utilisez pas l'appareil, éteignez-le. Si vous ne l'utilisez pas pendant une longue période, débranchez la batterie.
- Vérifiez régulièrement la batterie, le chargeur et les autres pièces. Si vous constatez des dommages, assurez-vous de les réparer avant de les utiliser.

Charging notification

- Avant la première utilisation, chargez la batterie pendant 10 heures.
- Placez le chargeur dans le port situé sous le siège, puis branchez le chargeur dans la prise.
- La voiture ne peut pas être utilisée pendant la charge.
- Ne chargez pas pendant plus de 12 heures.
- Pendant la charge, il est normal que la batterie et le chargeur soient chauds.
- Ne chargez pas la batterie si la prise est mouillée afin d'éviter les risques électriques ou un court-circuit.
- Utilisez uniquement le chargeur fourni par le fabricant. Tout autre chargeur peut endommager la batterie ou provoquer un court-circuit.
- Si vous n'utilisez pas le produit pendant une longue période, veillez à le recharger une fois par mois.
- Si elle n'est pas utilisée pendant une longue période, assurez-vous qu'elle soit chargée une fois par mois.

Les étapes de chargement sont les suivantes:

Étape 1: Le port de charge se trouve sous le siège.

Étape 2: Insérez la fiche du chargeur dans le trou.

Étape 3: Branchez le chargeur sur une prise de courant.

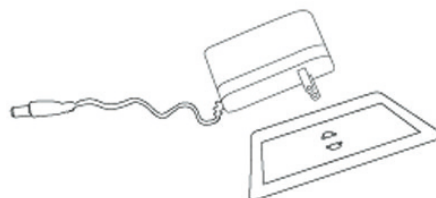

Avertissement : La voiture doit être chargée par un adulte. Ce produit ne peut pas être utilisé pendant la charge.

Dépannage

Panne	Analyse	Solutio
La voiture ne peut pas avancer	Faible puissance de la batterie	Chargez la batterie
	Fusible protégé	Réutilisez quelques minutes plus tard
	L'alimentation n'est pas branchée	Rallumez-la
	Fil de batterie desserrée	Reconnectez
	Batterie endommagée	Remplacez-en un nouveau
	Appareil électrique endommagé	Remplacez-en un nouveau
La batterie ne peut pas être rechargée	Moteur endommagé	Remplacez-en un nouveau
	Connecteur de batterie desserré	Reconnectez
	Chargeur non branché	Reconnectez
La voiture ne roule pas très longtemps	Chargeur endommagé	Remplacez-en un nouveau
	Faible puissance de la batterie	Faible puissance de la batterie
Le chargeur est chaud lors de la charge	Batterie vieille	Batterie vieille
	Réaction chimique	Normal
Vitesse lente	Batterie vieille	Remplacez-en un nouveau
	Puissance de la batterie faible	Rechargez
	Surcharge	Réduisez le poids en dessous de 25 KG
	La route n'est pas régulière	Roulez dans une zone lisse

Entretien et Service

- Vérifiez régulièrement la batterie, le chargeur et les autres pièces. S'il y a des dommages, assurez-vous de les réparer avant toute utilisation.
- Pour les pièces, utilisez de l'huile lubrifiante. Gardez ce produit à l'écart des flammes nues et du rayonnement direct du soleil.
- Rangez-le à l'intérieur et protégez-le avec une housse imperméable.
- Tenez-le à l'écart des matériaux inflammables pour prévenir les risques d'incendie.
- Chargez le produit après chaque utilisation.
- Nettoyez l'appareil à l'aide d'un chiffon sec. N'utilisez pas de solvants chimiques pour essuyer les pièces en plastique. Ne pas laver avec de l'eau. Ne l'utilisez pas lorsqu'il pleut ou qu'il neige - l'eau peut endommager le moteur, le système électrique ou la batterie.
- Mettez l'appareil hors tension après chaque utilisation.
- N'utilisez que le chargeur fourni par le fabricant.
- Ne modifiez pas cette voiture ou son fil électrique de quelque manière que ce soit .



- Musik
- Weiterleiten



WARNING: Dieses Gerät muss von einem Erwachsenen zusammengebaut werden. Im unmontierten Zustand befinden sich kleine und scharfe Teile, die verschluckt werden können. Bewahren Sie sie außerhalb der Reichweite von Kleinkindern auf.

Warnung: Nicht im Straßenverkehr verwenden.

**WICHTIG, FÜR DIE SPÄTERE VERWENDUNG AUFBEWAHREN:
SORGFÄLTIG DURCHLESEN**

MONTAGEANWEISUNGEN

Sehr geehrter Kunde,

Vielen Dank, dass Sie dieses Produkt erworben haben. Damit Ihr Gerät Ihnen gute Dienste leistet, lesen Sie bitte alle Hinweise in diesem Benutzerhandbuch. Wenn Sie Fragen haben, wenden Sie sich bitte an unser Kundendienstzentrum.

Unsere Kontaktdaten stehen unten:

 0049-0(40)-88307530

 service@aosom.de

ADRESSE DES IMPORTEURE:

MH Handel GmbH

















Wendenstraße 309

D-20537 Hamburg

Germany

IN CHINA HERGESTELLT

TEILE

 A x 1 Karosserie	 B x 1 Korb	 C x 1 Kopfstück	
 D x 3 Rad	 E x 1 Antriebsrad	 F x 1 Lenker	
 G x 4 Radabdeckung	 H x 1 M8-Schlüssel	 I x 1 Sitz	
 J x 1 Motor	 K x 1 Hinterachse	 L x 9 Unterlegscheibe	
 M x 1 M8-Mutter	 N x 4 Splint	 O x 4 Schraube	 P x 1 Ladegerät



Produktspezifikation

Batterie	6V
Geeignetes Alter	18-48 Monate
Ladekapazität	25kg
Produktabmessungen	70*42*45cm
Geschwindigkeit	1.0-3.0km/h
Lade-/Nutzungszeit	Aufladen 8-12 Stunden, Verwendung 45 Minuten
Ladegerät	6V

Function

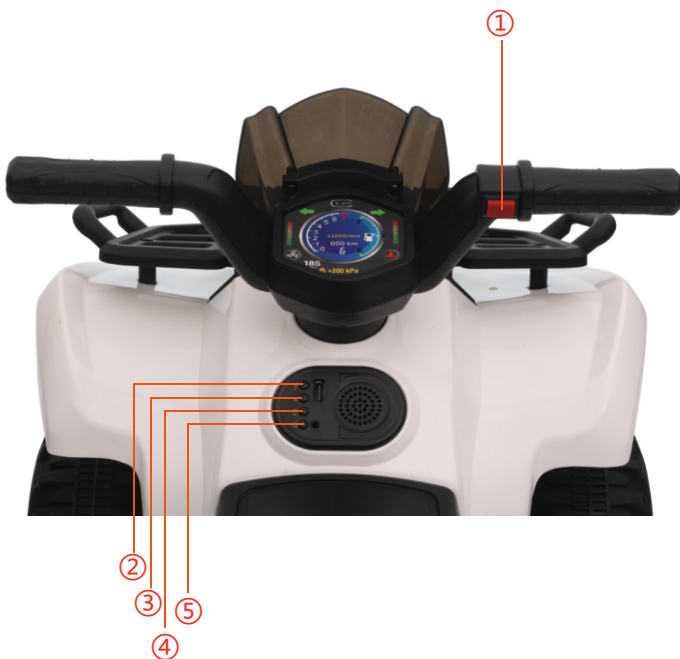

- ① Marche avant
- ② Commutateur de musique / Volume -
- ③ Pause/lecture
- ④ Commutateur de musique / Volume +
- ⑤ Interrupteur d'alimentation de musique

Zusammenbau

1. Zusammenbau des Vorderrads

Fügen Sie nacheinander 1 Stück Unterlegscheibe, 1 Stück Rad und 1 Stück Unterlegscheibe hinzu und verwenden Sie 1 Stück Splint zum Festziehen (biegen Sie den Splint mit einer Zange). Zum Schluss stecken Sie 1 Stück Radabdeckung in das Rad ein. Die gleichen Schritte für den Zusammenbau auf der anderen Seite.



2. Zusammenbau der Hinterachse, des Rad und Motors

Fügen Sie 1 Stück Unterlegscheibe von der langen Seite her in die Hinterachse ein. Drehen Sie die Karosserie um und stecken Sie die Hinterachse wie abgebildet in die Karosserie ein. Fügen Sie 1 Stück Motor, 1 Stück Antriebsrad, 1 Stück Unterlegscheibe nacheinander auf der linken Seite der Hinterachse hinzu, verwenden Sie 1 Stück Splint zum Festziehen (biegen Sie den Splint mit einer Zange), stecken Sie dann 1 Stück Radabdeckung in das Rad ein. Fügen Sie 1 Stück Unterlegscheibe, 1 Stück Rad, 1 Stück Unterlegscheibe nacheinander auf der rechten Seite der Hinterachse hinzu, verwenden Sie 1 Stück Splint zum Festziehen (biegen Sie den Splint mit einer Zange), und stecken Sie dann 1 Stück Radabdeckung in das Rad ein.



3. Zusammenbau der Lenkstange

Stecken Sie den Lenker in das Loch am Auto, dann stecken Sie den Richtungshebel in das Loch an der Vorderachse, fügen Sie 1 Stück Unterlegscheibe hinzu, verwenden Sie 1 Stück M8-Mutter zum Festziehen. Führen Sie die Lenkerleitung durch das Loch unter dem Sitz und verbinden Sie dann die Lenkerleitung mit der Fahrzeugleitung.



4. Zusammenbau von Korb und Kopfstück

Stecken Sie den Korb in die Löcher auf dem Auto, verwenden Sie 4 Stück Schraube zum Anziehen. Stecken Sie das Kopfstück in das Loch an der vorderen Stoßstange.



5. Verbinden Sie die Motorleistung und die Batterieleitung

Verbinden Sie zwei weiße Stecker (Motorleistung) wie in der Abbildung gezeigt.

Verbinden Sie zwei rote Stecker (Batterieleitung) wie in der Abbildung gezeigt.

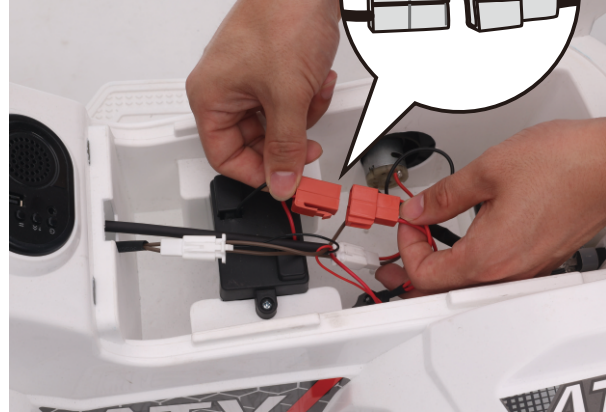

6. Zusammenbau des Sitzes

Stecken Sie den Sitz in das Auto ein und sichern Sie den Sitz.



WARNUNG

- Bitte befolgen Sie diese Anweisungen sorgfältig, um die Sicherheit der Kinder zu gewährleisten.
- Montage und Einstellung müssen von einem Erwachsenen vorgenommen werden, halten Sie Kinder fern.
- Beim Zusammenbau sind Kleinteile vorhanden, halten Sie kleine Kinder fern, um ein Verschlucken zu vermeiden.
- Kinder müssen während der Fahrt den Sicherheitsgurt anlegen.
- Das Fahren erfordert immer die Aufsicht eines Erwachsenen. Bringen Sie Kindern vor der Verwendung das Fahren bei.
- Niemals stehen oder spielen, wenn sich das Gerät bewegt.
- Der Akku darf nur von Erwachsenen aufgeladen werden. Laden Sie das Gerät vor der ersten Verwendung vollständig auf.
- Halten Sie Kinder von Plastikverpackungen fern, um Erstickungsgefahr zu vermeiden.
- Verwenden Sie nur Ersatzteile, die vom Hersteller angeboten werden.

- Das Ladegerät ist kein Spielzeug und sollte nicht zum Spielen verwendet werden.
- Maximale Belastung: 25 kg. Überlasten Sie das Gerät nicht.
- Geeignetes Alter: 18-48 Monate.

Die sichere Verwendung

- Nicht auf der Straße, im Straßenverkehr oder in der Nähe von Hängen und Gräben verwenden.
- Verändern Sie nicht die Verkabelung und bauen Sie keine elektrischen Geräte in das Fahrzeug ein.
- In einem trockenen Bereich verwenden und von Nässe fernhalten. Von offenen Flammen fernhalten.
- Geeignet für 1 Kinder. Überlasten Sie das Gerät nicht.
- Maximale Belastbarkeit: 25 kg.
- Schalten Sie das Gerät aus, wenn Sie es nicht verwenden. Wenn Sie das Gerät längere Zeit nicht verwenden, ziehen Sie den Stecker aus der Batterie.
- Überprüfen Sie den Akku, das Ladegerät und andere Teile regelmäßig. Wenn Schäden festgestellt werden, müssen diese vor der Verwendung behoben werden.

Ladebenachrichtigung

- Laden Sie den Akku vor der ersten Verwendung 10 Stunden lang auf.
- Setzen Sie das Ladegerät in die Öffnung unter dem Sitz ein und stecken Sie es in die Steckdose.
- Während des Ladevorgangs kann das Fahrzeug nicht verwendet werden.
- Laden Sie nicht länger als 12 Stunden.
- Beim Aufladen ist es normal, dass der Akku und das Ladegerät warm werden.
- Laden Sie nicht, wenn der Stecker nass ist, um elektrische Gefahren oder einen Kurzschluss zu vermeiden.
- Verwenden Sie nur das vom Hersteller angebotene Ladegerät. Jedes andere Ladegerät kann die Batterie beschädigen oder einen Kurzschluss verursachen.
- Wenn Sie das Gerät über einen längeren Zeitraum nicht verwenden, sollten Sie es einmal im Monat aufladen.

Die Schritte zum Aufladen sind wie folgt:

Schritt 1: Die Ladeöffnung befindet sich unter dem Sitz.

Schritt 2: Stecken Sie den Stecker des Ladegeräts in die Öffnung.

Schritt 3: Schließen Sie das Ladegerät an eine Steckdose an.

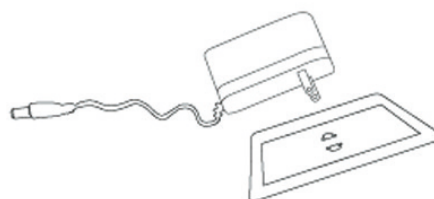

Warnung: Das Auto muss von einem Erwachsenen aufgeladen werden. Dieses Gerät kann während des Aufladens nicht verwendet werden.

Problemlösung

Problem	Analyse	Lösung
Das Fahrzeug kann sich nicht bewegen	Schwache Batterie Sicherungsschutz Das Fahrzeug schaltet sich nicht ein Batteriekabel lose Batterie beschädigt Elektrogerät beschädigt Motor beschädigt	Batterie aufladen Einige Minuten später wieder verwenden Schalten Sie das Gerät wieder ein Wieder verbinden Ersetzen Sie die Batterie mit einer neuen Ersetzen Sie die Batterie mit einer neuen Ersetzen Sie die Batterie mit einer neuen
Die Batterie kann nicht aufgeladen werden	Batteriestecker lose Ladegerät nicht nicht angeschlossen Schäden am Ladegerät	Wieder verbinden Neu anschließen Ersetzen Sie die Batterie mit einer neuen
Das Fahrzeug funktioniert nicht sehr lange	Schwache Batterieleistung Die Batterie ist alt	Aufladen Ersetzen Sie die Batterie mit einer neuen
Das Ladegerät erhitzt sich beim Laden	Chemische Reaktion	Normal
Langsame Geschwindigkeit	Die Batterie ist alt Schwache Batterieleistung Überlastet Die Fahrbahn ist uneben	Ersetzen Sie die Batterie mit einer neuen Aufladen Reduzieren Sie das Gewicht unter 25 kg In einem ebenen Bereich verwenden

Wartung und Service

- Überprüfen Sie den Akku, das Ladegerät und andere Teile regelmäßig. Wenn es irgendwelche Schäden gibt, stellen Sie sicher, dass diese vor der Verwendung behoben werden.
- Verwenden Sie Schmieröl für die Teile. Halten Sie dieses Gerät von offenen Flammen und direkter Sonneneinstrahlung fern.
- Lagern Sie es in geschlossenen Räumen und verwenden Sie eine wasserfeste Abdeckung.
- Halten Sie das Gerät von brennbaren Materialien fern, um Brandgefahren zu vermeiden.
- Laden Sie das Gerät nach jeder Verwendung auf.
- Reinigen Sie es mit einem trockenen Tuch. Verwenden Sie keine chemischen Lösungsmittel zum Abwischen von Kunststoffteilen. Nicht mit Wasser abwaschen. Verwenden Sie das Gerät nicht bei Regen oder Schnee - Wasser kann den Motor, das elektrische System oder die Batterie beschädigen.
- Schalten Sie den Strom nach jeder Verwendung aus.
- Verwenden Sie nur das vom Hersteller angebotene Ladegerät.
- Verändern Sie weder das Fahrzeug noch die Verkabelung in irgendeiner Weise.



- Música
- Hacia adelante



ADVERTENCIA: Este producto debe ser ensamblado por un adulto. Cuando está desmontado, hay piezas pequeñas y afiladas que podrían ahogarse si se tragan. Manténgase fuera del alcance de los niños pequeños.
Advertencia: No lo use en el tráfico.

**IMPORTANTE, CONSERVAR PARA FUTURAS CONSULTAS:
LEER DETENIDAMENTE.**

INSTRUCCIONES DE MONTAJE

Queridos clientes,

Gracias por comprar este producto. Para que su electrodoméstico le sirva mejor, lea todas las instrucciones de este manual del usuario. Si tiene alguna pregunta, comuníquese con nuestro Centro de Atención al Cliente.

Nuestros datos de contacto son los siguientes:

 0034-931294512

 atencioncliente@aosom.es

IMPORTADOR:

SPANISH AOSOM, S.L.

C/ ROC GROS, N° 15. 08550, ELS HOSTALETES

DE BALENYÀ, SPAIN.

B66295775

















WWW.AOSOM.ES

ATENCIONCLIENTE@AOSOM.ES

TEL: 931294512

HECHO EN CHINA

PARTS

 A x 1 Cuerpo principal	 B x 1 Cesta	 C x 1 Parachoques
 D x 3 Rueda	 E x 1 Rueda motriz	 F x 1 Manillar
 G x 4 Tapacubos	 H x 1 Llave M8	 I x 1 Asiento
 J x 1 Motor	 K x 1 Eje posterior	 L x 9 Arandela
 M x 1 Tuerca M8	 N x 4 Pasador de chaveta	 O x 4 Tornillo
		 P x 1 Cargador



Especificaciones

Batería	6V
Edad adecuada	18-48 meses
Carga máxima	25kg
Medidas	70*42*45cm
Velocidad	1.0-3.0km/h
Tiempo	Carga 8-12h, Uso 45min
Cargador	6V

Funciones

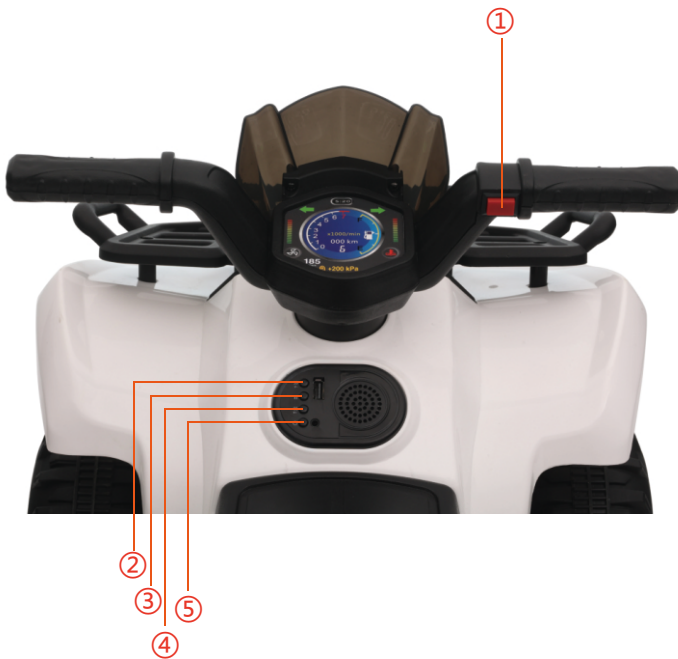

- ① Hacia adelante
- ② Cambio de música/Volumen -
- ③ Pausa / reproducir
- ④ Cambio de música/Volumen +
- ⑤ Encendido de la música

Instrucciones de montaje

1. Montaje de la rueda delantera

Agregue 1 arandela, 1 rueda, 1 arandela paso a paso, use 1 chaveta para apretar (doble la chaveta con unos alicates). Por último, inserte 1 cubierta de rueda en la rueda. El mismo paso de montaje para el otro lado.



2. Eje trasero, rueda y motor

Agregue una arandela de 1 pieza al eje trasero desde el lado largo. Voltee la carrocería del automóvil, luego inserte el eje trasero en la carrocería del automóvil como se muestra en la imagen. Agregue 1 motor, 1 rueda motriz, 1 arandela paso a paso en el lado izquierdo del eje trasero, use 1 chaveta para apretar (doble la chaveta con un alicate), luego inserte 1 cubierta de rueda en la rueda. Agregue 1 arandela, 1 rueda, 1 arandela paso a paso en el lado derecho del eje trasero, use 1 chaveta para apretar (doble la chaveta con un alicate), luego inserte 1 tapa de rueda en la rueda.



3. Montaje del manillar

Inserte el manillar en el orificio del automóvil, luego inserte la palanca de dirección en el orificio del eje delantero, agregue 1 arandela, use 1 tuerca M8 para apretar. Pase la línea del manillar a través del orificio debajo del asiento, luego conecte la línea del manillar y la línea del automóvil.



4. Montaje de la cesta y el parachoques

Inserte la canasta en los orificios del automóvil, use 4 tornillos para apretar. Inserte la viga amortiguadora en el orificio del parachoques delantero.



5. Conecte la línea del motor y la línea de la batería

Conecte dos conectores blancos (línea de motor) como en la imagen.
Conecte dos conectores rojos (línea de motor) como en la imagen.

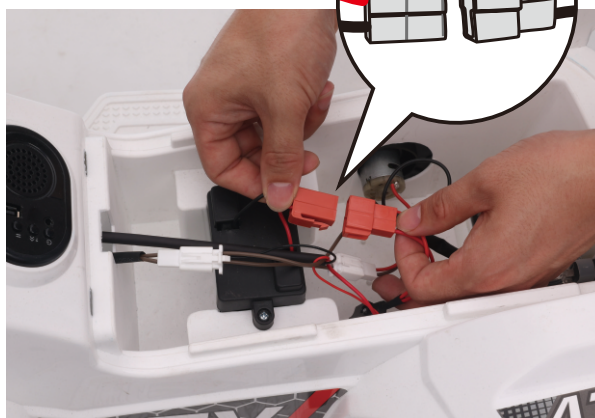

6. Montaje del asiento

Inserte el asiento en el automóvil, luego bloquee el asiento.



ADVERTENCIA

- Para la seguridad de los niños, siga atentamente estas instrucciones.
- Se requiere montaje y ajuste por parte de un adulto, mantenga alejados a los niños.
- Las piezas pequeñas están presentes al ensamblar, mantenga alejados a los niños pequeños para evitar que se ahoguen.
- Los niños deben usar el cinturón de seguridad al montar.
- Siempre se requiere la supervisión de un adulto al montar. Enseñe a los niños cómo montar antes de usar.
- Nunca se ponga de pie ni juegue cuando el producto esté en movimiento.
- Batería para ser cargada solo por adultos. Cargue completamente el producto antes del primer uso.
- Mantenga a los niños alejados de los envases de plástico para evitar la asfixia.
- Utilice únicamente piezas de repuesto proporcionadas por el fabricante.
- El cargador no es un juguete y no se debe jugar con él.
- Carga máxima: 25 kg. No sobrecargue.
- Edad recomendada: 18-48 meses.

Uso seguro

- No lo use en la calle, en la carretera o cerca de pendientes y zanjas.
- No cambie el cable ni agregue dispositivos eléctricos al automóvil.
- Úselo en un área seca, manteniéndolo alejado de condiciones húmedas. Mantener alejado de llamas abiertas.
- Adecuado para 1 niños. No sobrecargue.
- La capacidad máxima es de 25 kg.
- Cuando no esté en uso, desconecte la alimentación. Si no está en uso durante un período prolongado, desenchufe la batería.
- Revise la batería, el cargador y otras partes con regularidad. Si se encuentran daños, asegúrese de que estén reparados antes de usar.

Notificación de carga

- Antes del primer uso, cárguelo durante 10 horas.
- Coloque el cargador en el orificio debajo del asiento, luego enchufe el cargador en el enchufe.
- El coche no se puede utilizar durante la carga.
- No cargue durante más de 12 horas.
- Durante la carga, es normal que la batería y el cargador estén calientes.
- No cargue si el enchufe está mojado para evitar riesgos eléctricos o un cortocircuito.
- Utilice únicamente el cargador proporcionado por el fabricante. Cualquier otro cargador puede dañar la batería o provocar un cortocircuito.
- Si no está en uso durante un período prolongado, asegúrese de que se cargue una vez al mes

Pasos de carga:

Paso 1: El orificio de carga está debajo del asiento.

Paso 2: coloque el enchufe del cargador en el orificio.

Paso 3: Conecte el cargador a una toma de corriente.

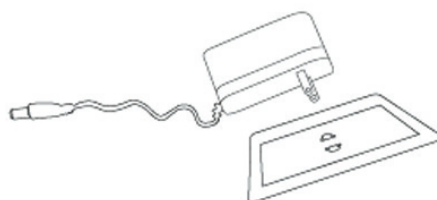

Advertencia: El coche debe ser cargado por un adulto. Este producto no se puede utilizar durante la carga.

Solución de problemas

Problema	Análisis	Solución
El coche no puede moverse	Protección de fusible de baja potencia	Cargar batería
	La energía no enciende	Intentar unos minutos más tarde
	Línea de batería suelta	Enciéndalo de nuevo
	Batería/motor dañada/o	Reemplace por uno nuevo
La batería no se puede recargar	Dispositivo eléctrico dañado	Reemplace por uno nuevo
	Conector de batería suelto	Reconectar
	Cargador no enchufado	Vuelva a enchufar
El coche no dura mucho	Cargador dañado	Reemplace por uno nuevo
	Batería baja	Recargar
El coche no dura mucho	La batería es vieja	Reemplace por una nueva
	El cargador se nota caliente al cargar	Reacción química
Velocidad lenta	La batería es vieja	Reemplace por una nueva
	Batería baja	Recarga
	Sobrecargada	Reducir a un peso inferior a 25kg
	Suelo inadecuado	Juega en un área lisa

Mantenimiento y Servicio

- Revise la batería, el cargador y otras partes con regularidad. Si hay algún daño, asegúrese de que esté reparado antes de usarlo.
- Utilice aceite lubricante para las piezas. Mantenga este producto alejado de llamas abiertas y fuera de la luz solar directa.
- Guárdelo en el interior y use una cubierta resistente al agua.
- Manténgase alejado de materiales inflamables para evitar riesgos de incendio.
- Cargue el producto después de cada uso.
- Limpiar con un paño seco. No utilice disolventes químicos para limpiar las piezas de plástico. No lavar con agua. No lo use cuando llueve o nieva: el agua puede dañar el motor, el sistema eléctrico o la batería.
- Desconecte la alimentación después de cada uso.
- Utilice únicamente el cargador proporcionado por el fabricante.
- No modifique este automóvil ni su cableado eléctrico de ninguna manera.



- Música
- Avanço



AVISO: Este produto deve ser montado por um adulto. Quando não montado, existem peças pequenas e afiadas, que podem ser asfixiadas se engolidas. Manter fora do alcance das crianças pequenas.

Atenção: Não utilizar no tráfego.

IMPORTANTE, RETER PARA REFERÊNCIA FUTURA: LER ATENTAMENTE

INSTRUÇÃO DE MONTAGEM

Caros clientes,

Obrigado por adquirir este produto. Para que o seu aparelho o sirva melhor, leia todas as instruções deste manual do utilizador. Se tiver alguma dúvida, por favor contacte o nosso Centro de Atendimento ao Cliente.

Os nossos dados de contacto são os seguintes:



0034-931294512



info@aosom.pt.

IMPORTADOR:

SPANISH AOSOM, S.L

C.ROC GROS N.15, 08550. ELS HOSTALETS DE BALENYÀ

TEL: 931294512 (SEG-SEX DAS 7:30H ÀS 16:30H)

INFO@AOSOM.PT

WWW.AOSOM.PT

PARTES

Estrutura

A x 1



Cesta

B x 1



Pára-choques

C x 1



Roda

D x 3



Roda motriz

E x 1



Guiador

F x 1



Cobertura da roda

G x 4



Chave M8

H x 1



Assento

I x 1



Motor

J x 1



Eixo traseiro

K x 1



Arruela

L x 9



Porca M8

M x 1



Pino

N x 4



Parafuso

O x 4



Carregador

P x 1



Especificação do produto

Bateria	6V
Idade adequada	18-48 meses
Capacidade de carga	25kg
Tamanho do produto	70*42*45cm
Velocidade	1.0-3.0km/h
Carga/tempo de utilização	Carregar 8-12 horas, utilizar 45m
Carregador	6V

Função

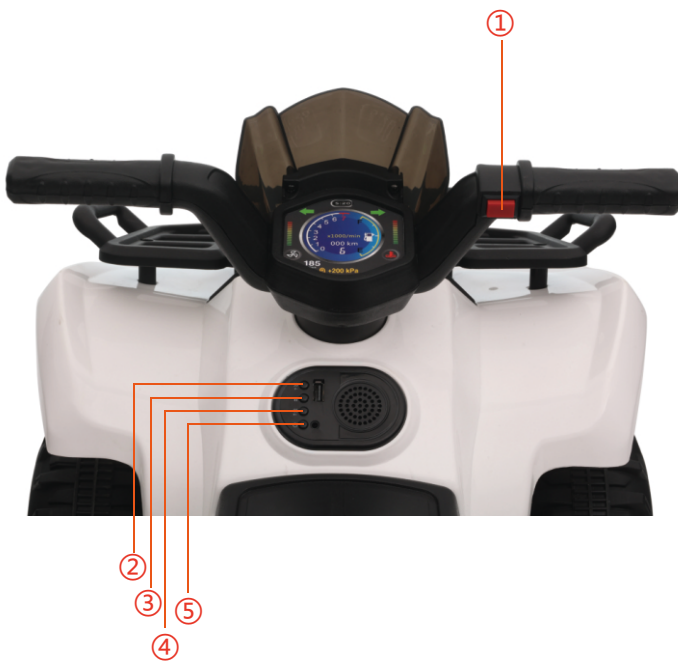

- ① Em frente
- ② Troca de música/Volume -
- ③ Pausa/reproduzir
- ④ Troca de música/Volume +
- ⑤ Ligar música

Instruções de montagem

1. Montagem da roda dianteira

Adicionar 1 arruela, 1 roda, 1 arruela, utilizar o pino para apertar (apertar o pino com um alicate). Finalmente, inserir a cobertura da roda. Seguir o mesmo passo de montagem do outro lado.



2. Eixo traseiro, roda e motor

Acrescentar uma 1 arruela ao eixo traseiro a partir do lado comprido. Virar a estrutura do carro, em seguida inserir o eixo traseiro a estrutura do carro, como se mostra na imagem. Adicionar 1 motor, 1 roda motriz, 1 arruela no lado esquerdo do eixo traseiro, utilizar 1 pino para o eixo traseiro para apertar (apertar o pino com alicate), depois inserir 1 cobertura da roda. Adicionar 1 arruela, 1 roda, 1 arruela no lado direito do eixo traseiro, usar 1 pino para apertar lado direito do eixo traseiro (apertar o pino com alicate), depois inserir 1 cobertura de roda na roda.



3. Montagem do guidador

Inserir o guidador no orifício do carro, depois inserir a alavanca de direção no orifício do eixo dianteiro, adicionar uma arruela, utilizar uma porca M8 para apertar. Passar a linha do guidador através do orifício de baixo do banco, depois ligar a linha do guidador e a linha do carro.



4. Montagem de cesto do pára-choque

Inserir o cesto nos orifícios do carro, usar parafuso para apertar. Inserir o pára-choque no orifício do pára-choques dianteiro.



5. Conectar a linha do motor e a linha da bateria

Conectar dois conectores brancos (linha do motor) como imagem. Conectar dois conectores vermelhos (linha de bateria), como na imagem.



6. Montagem do assento

Inserir o assento no carro, depois bloquear o assento.



⚠️ ATENÇÃO

- É necessária a montagem e ajuste de adultos, manter as crianças afastadas.
- As peças pequenas estão presentes quando da montagem, mantenha as crianças pequenas afastadas para evitar asfixia.
- As crianças devem usar o cinto de segurança ao conduzir o veículo.
- É sempre necessária a supervisão de um adulto quando a criança está a utilizar o carro.
- Nunca ficar de pé ou brincar quando o produto está em movimento.
- A bateria deve ser carregada apenas por adultos. Carregar totalmente o produto antes da primeira utilização.
- Manter as crianças afastadas de embalagens de plástico para evitar asfixia.
- Utilizar apenas peças sobressalentes que são fornecidas pelo fabricante.
- O carregador não é um brinquedo e não deve ser utilizado como um.
- Carga máxima: 25kg. Não sobrecarregar.
- Idade adequada: 18-48 meses.

Utilização segura

- Não utilizar na rua, na estrada ou perto de declives e valas.
- Não mudar o cabo ou adicionar dispositivos eléctricos ao carro.
- Utilizar numa zona seca, mantendo-se afastado de condições húmidas. Manter afastado do fogo.
- Adequado para 1 crianças. Não sobrecarregar.
- A capacidade máxima é de 25kg.
- Quando não estiver a ser utilizado, desligar a corrente. Se não estiver a ser utilizado durante um longo período, desligar a bateria.
- Verificar regularmente a bateria, carregador e outras peças. Se forem encontrados danos, certifique-se de que estão em fixadas antes de utilizar.

Carregamento

- Antes da primeira utilização carregar por 10 horas.
- Colocar o carregador no orifício debaixo do assento, depois ligar o carregador à tomada.
- O carro não pode ser utilizado quando estiver a carregar.
- Não carregue durante mais de 12 horas.
- Ao carregar, é normal que a bateria e o carregador estejam quentes.
- Não carregar se a ficha estiver molhada para evitar riscos eléctricos ou um curto-circuito.
- Utilizar apenas o carregador fornecido pelo fabricante. Qualquer outro carregador pode danificar a bateria ou provocar um curto-circuito.
- Se não for utilizado durante um longo período de tempo, certifique-se de que é carregado uma vez por mês.

As etapas de carregamento são as seguintes

Passo 1: O orifício de carga está debaixo do banco.

Passo 2: Colocar a ficha do carregador no orifício.

Passo 3: Ligar o carregador a uma tomada de alimentação.

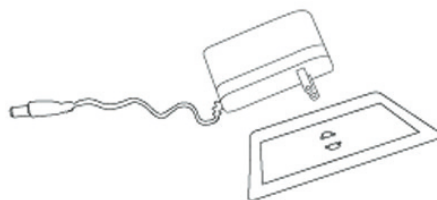

Advertência: O carro deve ser carregado por um adulto. Este produto não pode ser utilizado quando estiver a carregar.

Solução de problemas

Problema	Causa	Solução
O carro não se pode mover	Bateria com pouca energia	Carregar a bateria
	Protecção de fusíveis	Reutilizar alguns minutos mais tarde
	Energia não ligada	Voltar a conectá-lo
	Cabo de bateria solto	Voltar a conectá-la
	Bateria danificada	Substituir por um novo
	Dispositivo eléctrico danificado	Substituir por um novo
A bateria não pode ser recarregada	Motor danificado	Substituir por um novo
	Conector de bateria solto	Reconectar
	Carregador não ligado	Reconectar
O carro não funciona por muito tempo	Danos no Carregador	Substituir por um novo
	Bateria com pouca energia	Recarga
O carregador aquece ao carregar	A bateria é velha	Substituir por uma nova
	Reação química	Normal
Velocidade lenta	A bateria é velha	Substituir por uma nova
	Bateria está com pouca energia	Recarga
	Sobrecarregado	Reduzir o peso abaixo de 25KG
	A estrada não é uniforme	Brincar numa zona plana

Manutenção e Serviço

- Verificar regularmente a bateria, carregador e outras peças. Se houver quaisquer danos, certifique-se de que é fixed antes de utilizar.
- Utilizar óleo lubrificante para peças. Manter este produto longe do fogos e fora da luz solar directa.
- Armazenar dentro de casa e utilizar uma cobertura resistente à água.
- Manter afastado de materiais inflamáveis para evitar os perigos de incêndio.
- Carregar o produto após cada utilização.
- Limpar com um pano seco. Não utilizar solventes químicos para limpar peças de plástico. Não lavar com água. Não utilizar quando estiver a chover ou nevar - a água pode danificar o motor, o sistema eléctrico ou a bateria.
- Desligar a corrente depois de cada utilização.
- Utilizar apenas o carregador fornecido pelo fabricante.
- Não modificar de forma alguma este carro ou o seu fio eléctrico.



- Musica
- Avanti

**AVVERTIMENTO:**

Questo prodotto deve essere assemblato da un adulto. Quando smontato, sono presenti parti piccole e taglienti che potrebbero soffocare se ingerite. Tenere fuori dalla portata dei bambini piccoli.

Avvertimento: Non utilizzare nel traffico.

IMPORTANTE! CONSERVARE IL PRESENTE MANUALE PER FUTURO RIFERIMENTO E LEGGERLO ATTENTAMENTE.

Caro Cliente,

Grazie per aver acquistato questo prodotto. Per servirti meglio con questo apparecchio ti prego di leggere tutte le istruzioni in presente manuale utente. In caso di dubbio, si prega di contattare il nostro centro assistenza clienti.

I nostri dettagli di contatto sono di seguito:

 0039-0249471447

 clienti@aosom.it

IMPORTATO DA:
AOSOM Italy srl
Centro Direzionale Milanofiori
Strada 1 Palazzo F1
20057 Assago (MI)
P.I.: 08567220960
FATTO IN CINA

PARTI



A x 1

Corpo principale



B x 1

Cestino



C x 1

Paraurti



D x 3

Ruota



E x 1

Ruota motrice



F x 1

Manubrio



G x 4

Coperchio ruota



H x 1

Chiave M8



I x 1

Sedile



J x 1

Motore



K x 1

Asse posteriore



L x 9

Rondella



M x 1

Dado M8



N x 4

Coppiglia



O x 4

Vite



P x 1

Caricabatterie



Specifiche del prodotto

Batteria	6V
Età adatta	18-48 mesi
Capacità di carico	25kg
Dimensione prodotto	70*42*45cm
Velocità	1,0-3,0km/ora
Carica/Durata uso	Carica 8- 12h , Uso 45min
Caricabatterie	6V

Funzioni

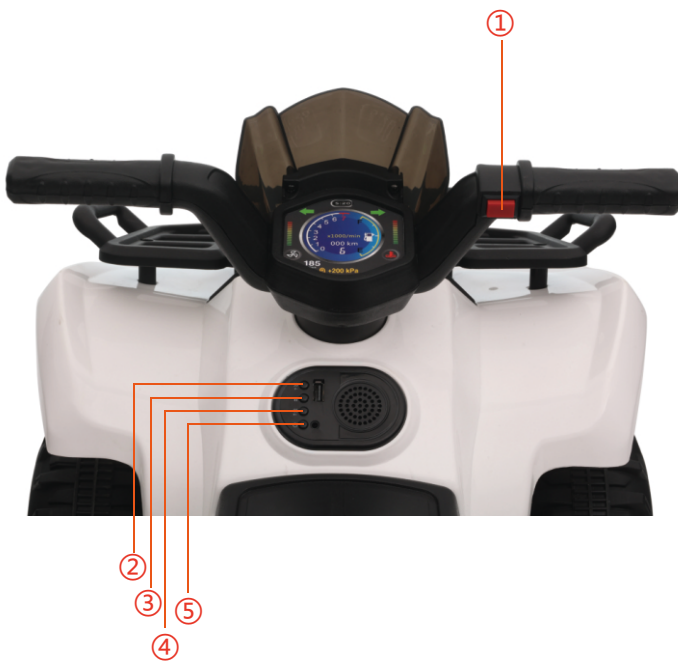

- ① Avanti
- ② Interruttore musica/Volume -
- ③ Pausa/ Riprodurre
- ⑤ Interruttore musica/Volume +
- ⑥ Interruttore di alimentazione della musica

Assemblaggio Installazione

1 . Assemblaggio della ruota anteriore

Aggiungere 1 pz di rondella, 1 pz di ruota, 1 pz di rondella passo dopo passo, utilizzare 1 pz di coppiglia per stringere (piegare la coppiglia con una pinza). Infine inserire 1 pz di coperchio ruota nella ruota. Lo stesso passaggio di montaggio per l'altro lato.



2 . Assemblaggio di Asse posteriore , Ruota e Motore

Aggiungere 1 pz di rondella all'asse posteriore dal lato lungo. Capovolgere il corpo principale, e poi inserire l'asse posteriore nel corpo principale come in foto. Aggiungere 1 pz di motore, 1 pz di ruota motrice, 1 pz di rondella passo dopo passo sul lato sinistro dell'asse posteriore, utilizzare 1 pz di coppiglia per stringere (piegare la coppiglia con una pinza), e poi inserire 1 pz di coperchio ruota nella ruota. Aggiungere 1 pz di rondella, 1 pz di ruota, 1 pz di rondella passo dopo passo sul lato destro dell'asse posteriore, utilizzare 1 pz di coppiglia per stringere (piegare la coppiglia con una pinza), e poi inserire 1 pz di coperchio ruota nella ruota .

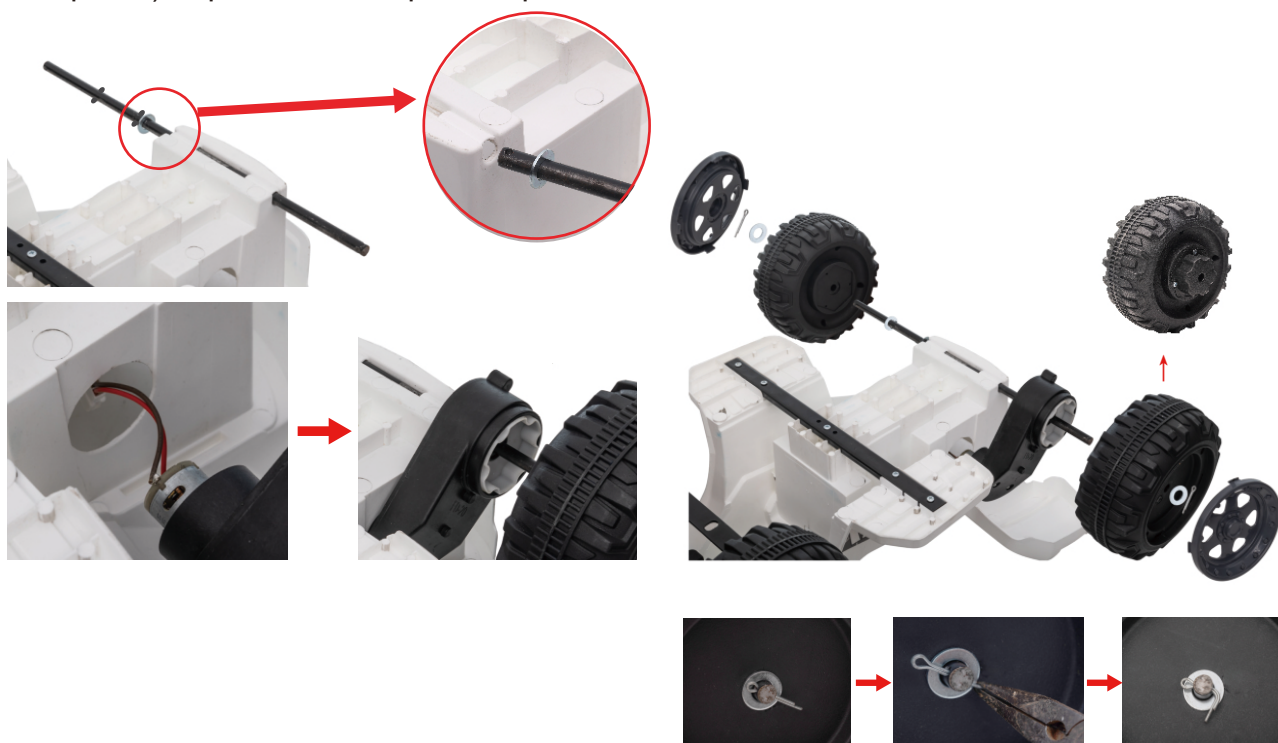

3 . Assemblaggio del manubrio

Inserire il Manubrio nel foro dell'auto, e poi inserire la leva di direzione nel foro sull'asse anteriore, aggiungere 1 pz di rondella, utilizzare 1 pz di dado M8 per serrare. Far passare il filo del manubrio attraverso il foro sotto il sedile, quindi collegare il cavo del Manubrio e il cavo dell'auto.



4 . Assemblaggio di Cestino e Paraurti

Inserire il cestino nei fori dell'auto, utilizzare 4 pz di vite per serrare. Inserire i paraurti nel foro sulla parte anteriore.



5 . Collegare il cavo Motore e il cavo Batteria

Collegare due connettori bianchi (cavo del motore) come nella foto.

Collegare due connettori rossi (cavo della batteria) come nella foto.

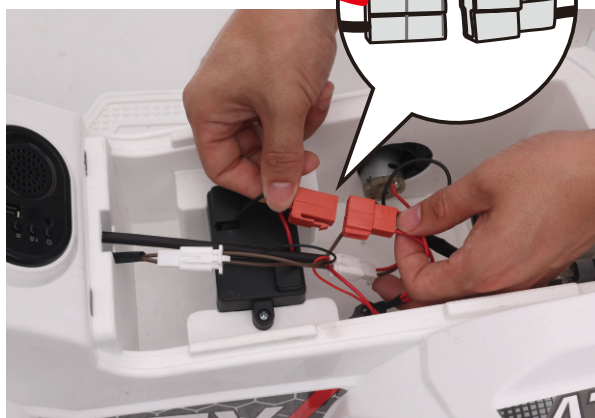

6 . Assemblaggio del Sedile



AVVERTIMENTO

Per la sicurezza dei bambini, seguire attentamente queste istruzioni.

- Sono necessari l'assemblaggio e la regolazione effettuati da adulti, tenere lontani i bambini.
- Sono presenti piccole parti nell'assemblaggio, tenere lontani i bambini per evitare il soffocamento.
- I bambini devono indossare la cintura di sicurezza durante la guida.
- Durante la guida è sempre necessaria la supervisione di un adulto. Insegnare ai bambini come guidare prima dell'uso.
- Non stare mai in piedi o giocare quando il prodotto è in movimento.
- Batteria che deve essere caricata solo da adulti. Caricare completamente il prodotto prima del primo utilizzo.
- Tenere i bambini lontano dagli imballaggi di plastica per evitare il soffocamento.
- Utilizzare solo pezzi di ricambio forniti dal produttore.
- Il caricabatterie non è un giocattolo e non deve essere giocato.
- Carico massimo: 25 Kg. Non sovraccaricare.
- Età adatta: 18-48 mesi.

Istruzioni di sicurezza per uso

- Non utilizzare in via, su strada o in prossimità di pendii e fossi.
- Non cambiare il cavo o aggiungere dispositivi elettrici all'auto.
- Utilizzare in un luogo asciutto, al riparo dall'umidità. Tenere lontano da fiamme libere.
- Adatto per 1 bambino. Non sovraccaricare.
- La capacità massima è di 25 kg.
- Quando non viene utilizzato, spegnere l'alimentazione. Se non viene utilizzato per un lungo periodo, scollegare la batteria.
- Controllare regolarmente la batteria, la caricabatterie e le altre parti. Se si verificano i danni, assicurarsi che siano riparati prima dell'uso.

Istruzioni per carica della batteria

- Prima del primo utilizzo, caricare la batteria per 10 ore.
- Posizionare la caricabatterie nel foro sotto il Sedile, e poi inserire la caricabatterie nella presa.
- L'auto non può essere utilizzata durante la ricarica.
- Non ricaricare oltre 12 ore.
- Durante la ricarica, è normale che la batteria e la caricabatterie siano calde.
- Non caricare se la spina è bagnata per evitare rischi elettrici o cortocircuiti.
- Utilizzare esclusivamente la caricabatterie fornita dal produttore. Qualsiasi altra caricabatterie può danneggiare la batteria o provocare un cortocircuito.
- Se non viene utilizzato per un lungo periodo, assicurarsi che venga ricaricato una volta al mese.

Passaggi per carica come quanto segue:

Passaggio 1: il foro di ricarica si trova sotto il sedile.

Passaggio 2: inserire la spina della caricabatterie nel foro.

Passaggio 3: collegare la caricabatterie a una presa di corrente.

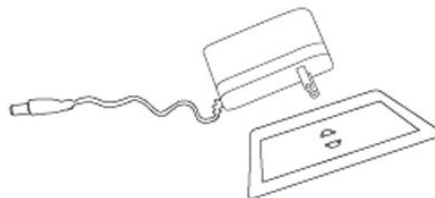

Avvertimento: L'auto deve essere ricaricata da un adulto. Questo prodotto non può essere utilizzato durante la ricarica.

Risoluzione Problemi

Tipo	Analisi	Soluzione
Il veicolo non si accende	Bassa tensione della batteria; Protezione dei dispositivi elettrici; L'interruttore non e' stato premuto correttamente; Allentamento del connettore di alimentazione; Guasto della batteria; Danneggiamento dei dispositivi elettrici; Guasto del generatore;	Caricare completamente la batteria; Usare il veicolo dopo qualche minuto; Usare il veicolo secondo le istruzioni fornite; Reinstallare il connettore; Sostituire la batteria; Sostituire i dispositivi elettrici; Sostituire il generatore.
Non e' possibile ricaricare la batteria	Allentamento del connettore della batteria; Il caricatore non sta ricaricando; Malfunzionamento del caricatore.	Reinstallare il connettore; Inserire nuovamente il caricatore; Sostituire il caricatore.
Il veicolo funziona per un breve tempo	La ricarica della batteria non e' stata completa; Batteria molto usurata.	Ricaricare completamente la batteria una seconda volta; Sostituire la batteria.
Vi sono rumori insoliti e surriscaldamento della batteria durante la ricarica	Reazioni chimiche.	Reazioni normali.
Il veicolo ha una velocita' bassa	Batteria molto usurata; Nessuna elettricit� in input per la batteria; Sovraccarico; Superficie di guida irregolare.	Sostituire la batteria; Ricaricare completamente la batteria; Ridurre il carico sotto i 25kg Guidare su una superficie regolare.

Manutenzione e Servizio

- Controllare regolarmente la batteria, la caricabatterie e altre parti. Se ci sono danni, assicurarsi che sia riparato prima dell'uso.
- Utilizzare olio lubrificante per le parti. Tenere questo prodotto lontano da fiamme libere e dalla luce solare diretta.
- Conservare all'interno e utilizzare una copertura resistente all'acqua.
- Tenere lontano da materiali infiammabili per evitare rischi di incendio.
- Ricaricare il prodotto dopo ogni utilizzo.
- Pulire con un panno asciutto .Non utilizzare solventi chimici per pulire le parti in plastica. Non lavare con acqua .Non utilizzare in caso di pioggia o neve, l'acqua pu  danneggiare il motore, il circuito elettrico o la batteria.
- Spegnere l'alimentazione dopo ogni utilizzo.
- Utilizzare esclusivamente la caricabatterie fornita dal produttore.
- Non modificare in alcun modo quest'auto o il suo cavo elettrico.

