

Vinsetto

IN220800473V02_GL

924-007_924-007V00

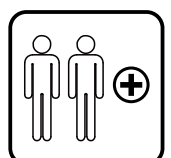
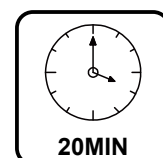
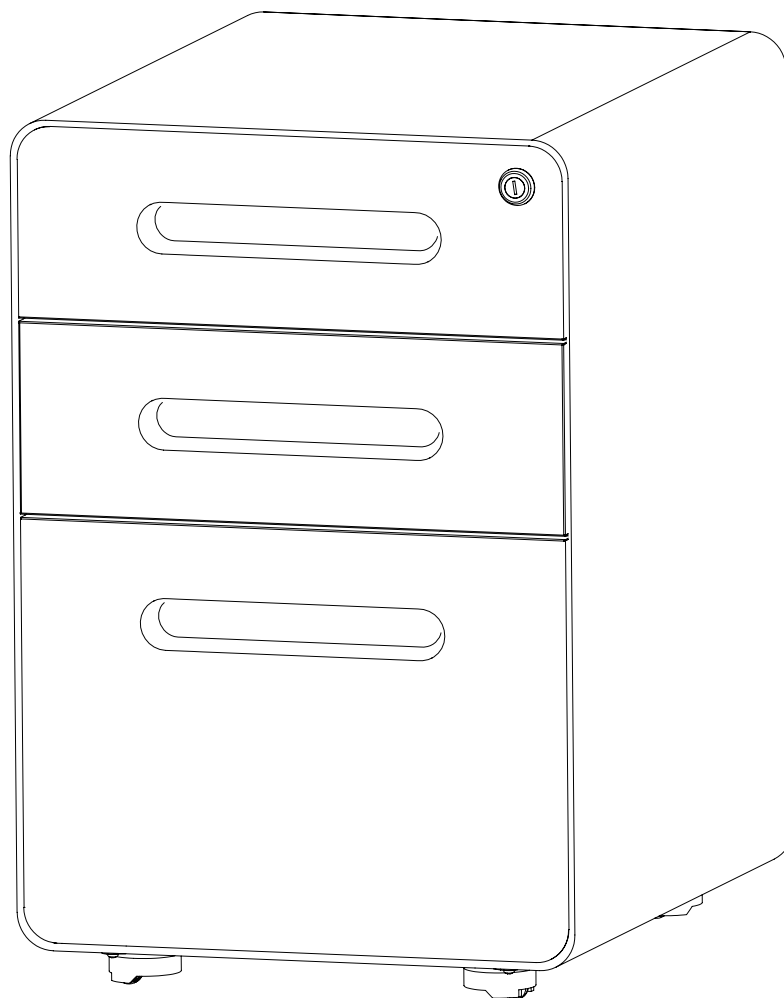

EN_ IMPORTANT, RETAIN FOR FUTURE REFERENCE: READ CAREFULLY.

FR_ IMPORTANT : A LIRE ATTENTIVEMENT ET À CONSERVER POUR CONSULTATION ULTÉRIEURE.

ES_ IMPORTANTE, LEA DETENIDAMENTE Y GUARDE PARA FUTURAS REFERENCIAS.

PT_ IMPORTANTE, GARDE PARA FUTURA REFERÊNCIA, LEIA ATENTAMENTE.

DE_ WICHTIG! SORGFÄLTIG LESEN UND FÜR SPÄTER NACHSCHLAGEN AUFBEWAHREN.

IT_ IMPORTANTE, LEGGERE E CONSERVARE QUESTO MANUALE D'ISTRUZIONE PER UN USO FUTURO.

EN

Dear customer,

Thank you for purchasing this product. So that your appliance serves you well, please read all the instructions in this user's manual. If you have any questions, please contact our customer care center, Our contact details are below:

FR

Cher client,

Nous vous remercions d'avoir acheté ce produit. Afin que vous puissiez profiter pleinement de votre appareil, veuillez lire toutes les instructions de ce manuel d'utilisation. Si vous avez la moindre question, veuillez contacter notre centre d'assistance à la clientèle, Nos coordonnées sont les suivantes:

DE

Sehr geehrter Kunde,

Vielen Dank, dass Sie dieses Produkt erworben haben. Damit Ihr Gerät Ihnen gute Dienste leistet, lesen Sie bitte alle Hinweise in diesem Benutzerhandbuch. Wenn Sie Fragen haben, wenden Sie sich bitte an unser Kundendienstzentrum, Unsere Kontaktdaten stehen unten:

ES

Queridos clientes,

Gracias por comprar este producto. Para que su electrodoméstico le sirva mejor, lea todas las instrucciones de este manual del usuario. Si tiene alguna pregunta, comuníquese con nuestro Centro de Atención al Cliente, Nuestros datos de contacto son los siguientes:

PT



Caros clientes,

Obrigado por adquirir este produto. Para que o seu aparelho o sirva melhor, leia todas as instruções deste manual do utilizador. Se tiver alguma dúvida, por favor contacte o nosso Centro de Atendimento ao Cliente, Os nossos dados de contacto são os seguintes:

IT

Caro Cliente,

Grazie per aver acquistato questo prodotto. Per servirti meglio con questo apparecchio ti prego di leggere tutte le istruzioni in presente manuale utente. In caso di dubbio, si prega di contattare il nostro centro assistenza clienti, I nostri dettagli di contatto sono di seguito:

Country	 Phone	 Email
US	001-877-644-9366	customerservice@aosom.com
CA	416-792-6088	customerservice@aosom.ca
UK	0044-800-240-4004	enquiries@mhstar.co.uk
DE	0049-0(40)-88307530	service@aosom.de
FR	0033-1-84166106	aosom@mhfrance.fr
ES	0034-931294512	atencioncliente@aosom.es
PT	0034-931294512	info@aosom.pt
IT	0039-0249471447	clienti@aosom.it



Ax12

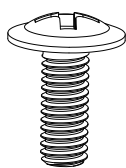

Bx 4

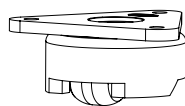

Cx 1

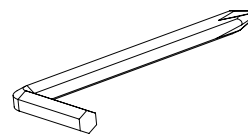

Dx 1

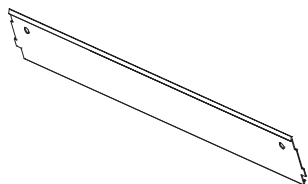

Ex 1

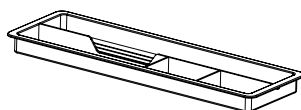

Hanging File Bar
Rail des dossiers suspendus
Barra de archivos colgantes
Barra de arquivo suspensa
Hängeregisterstange
Barra per cartelle sospese

(1)

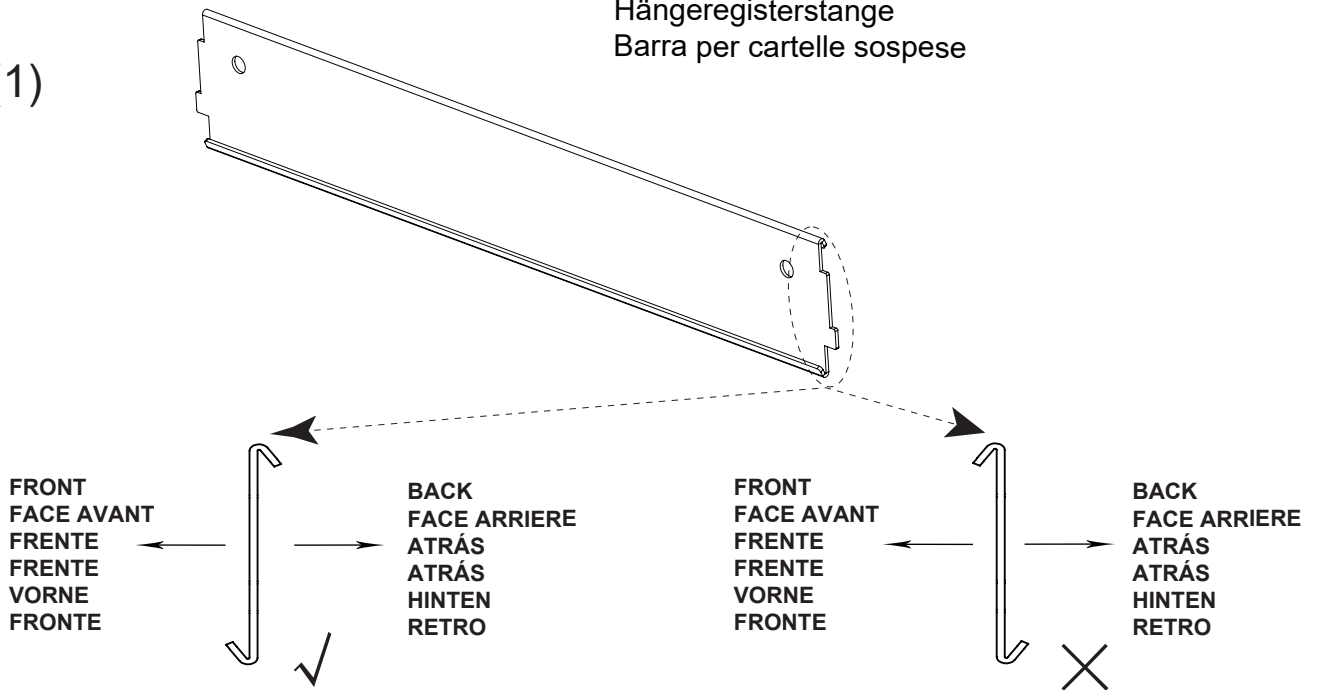

(2)

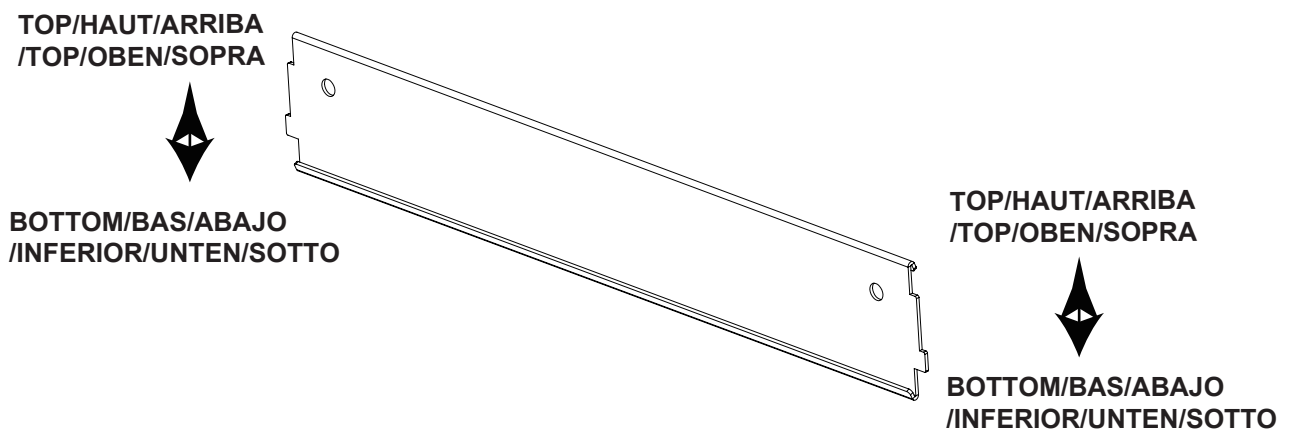

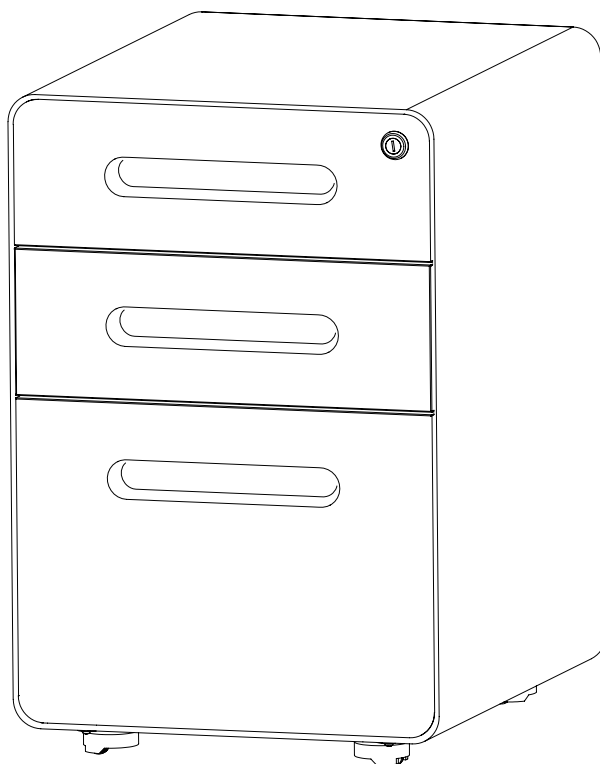
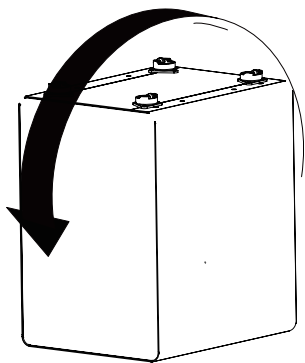
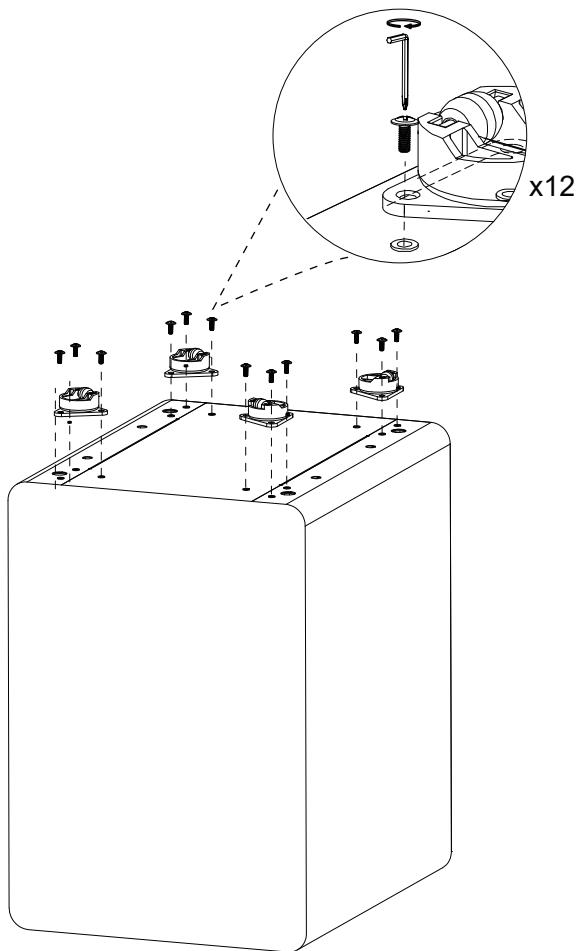
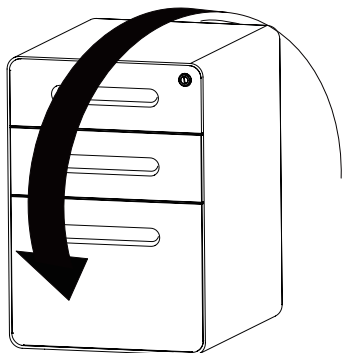
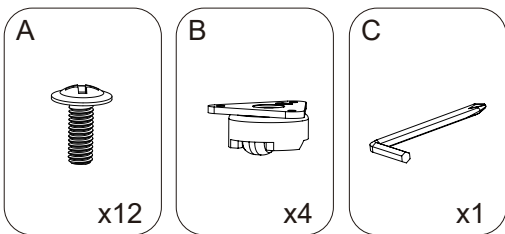

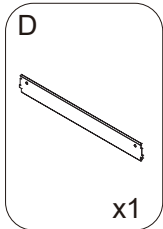

EN: Adjust the position of **D** Part for letter, A4, legal size files.

FR: Ajustez la hauteur de la pièce **D** en fonction du format des dossiers (lettre, A4, légal).

ES: Ajuste la posición de la parte **D** para archivos de tamaño carta, A4 y legal.

PT: Ajustar a posição da Parte **D** para ficheiros de tamanho carta, A4 e normal.

DE: Verstellen Sie die Position von Teil **D** für Ordner der Formate Letter, A4 und Legal.

IT: Regolare la posizione della parte **D** per i formati Legale, A4 e Lettera.

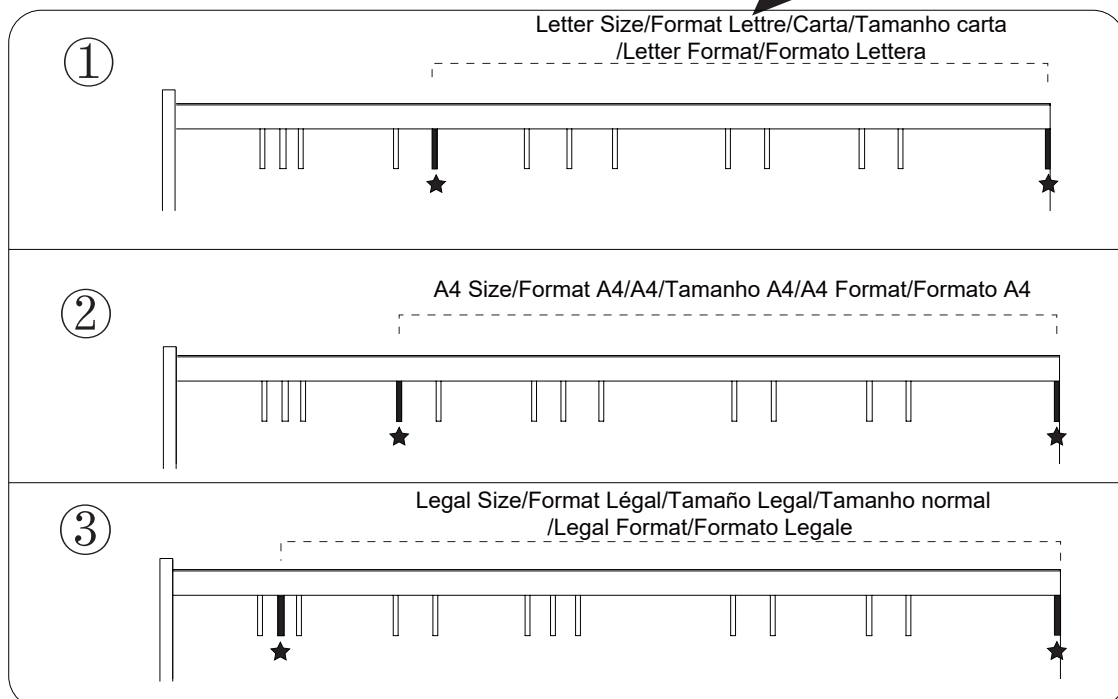
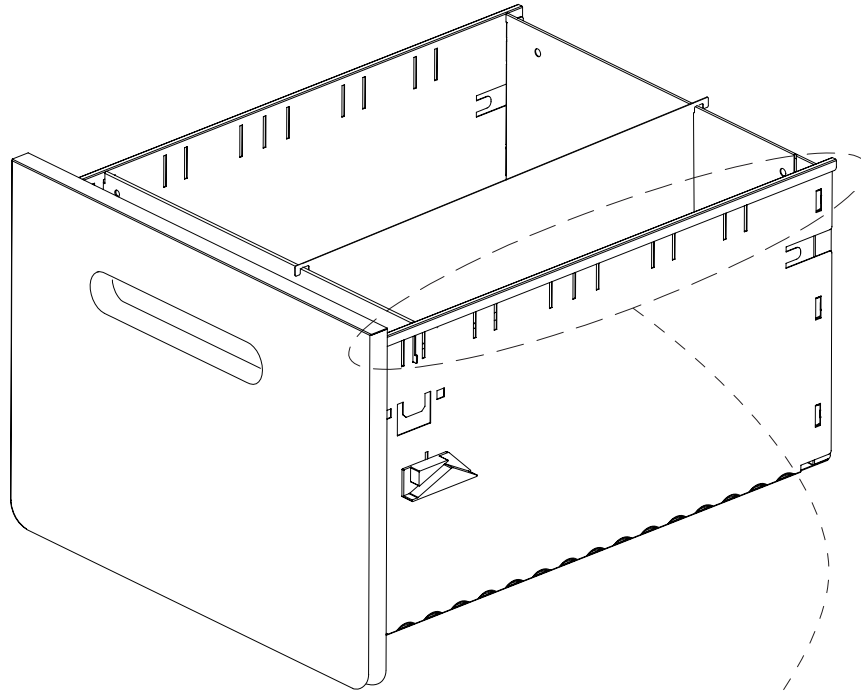

EN: Install or adjust the hanging file bar, please follow the below method.

FR: Pour installer ou ajuster le rail des dossiers suspendus, veuillez suivre la méthode ci-dessous.

ES: Instale o ajuste la barra de archivos colgantes, siga el método a continuación.

PT: Para instalar ou ajustar a barra de arquivo suspensa, siga os passos abaixo.

DE: Installieren oder verstellen Sie die Hängeregisterstange wie unten beschrieben.

IT: Installare o regolare la barra di supporto dei cavi, secondo il metodo seguente.

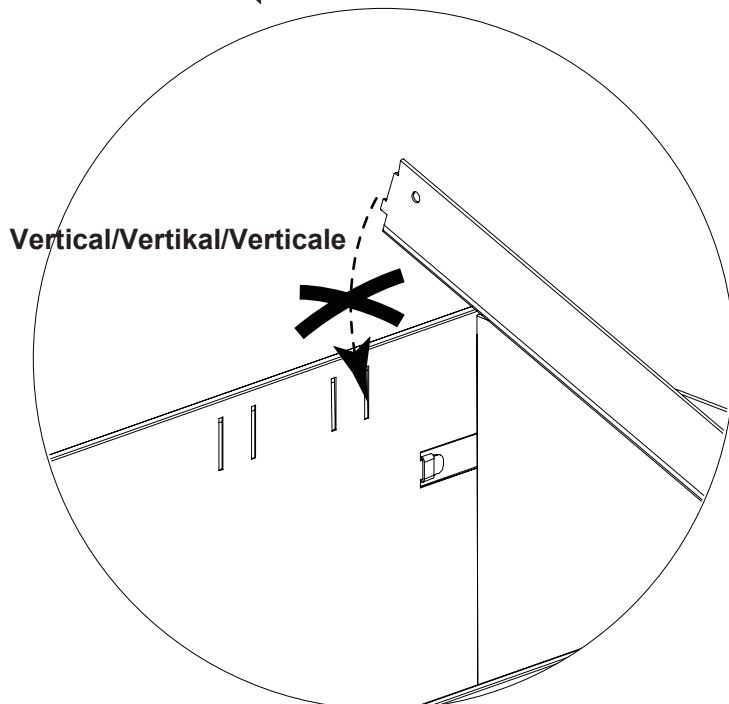
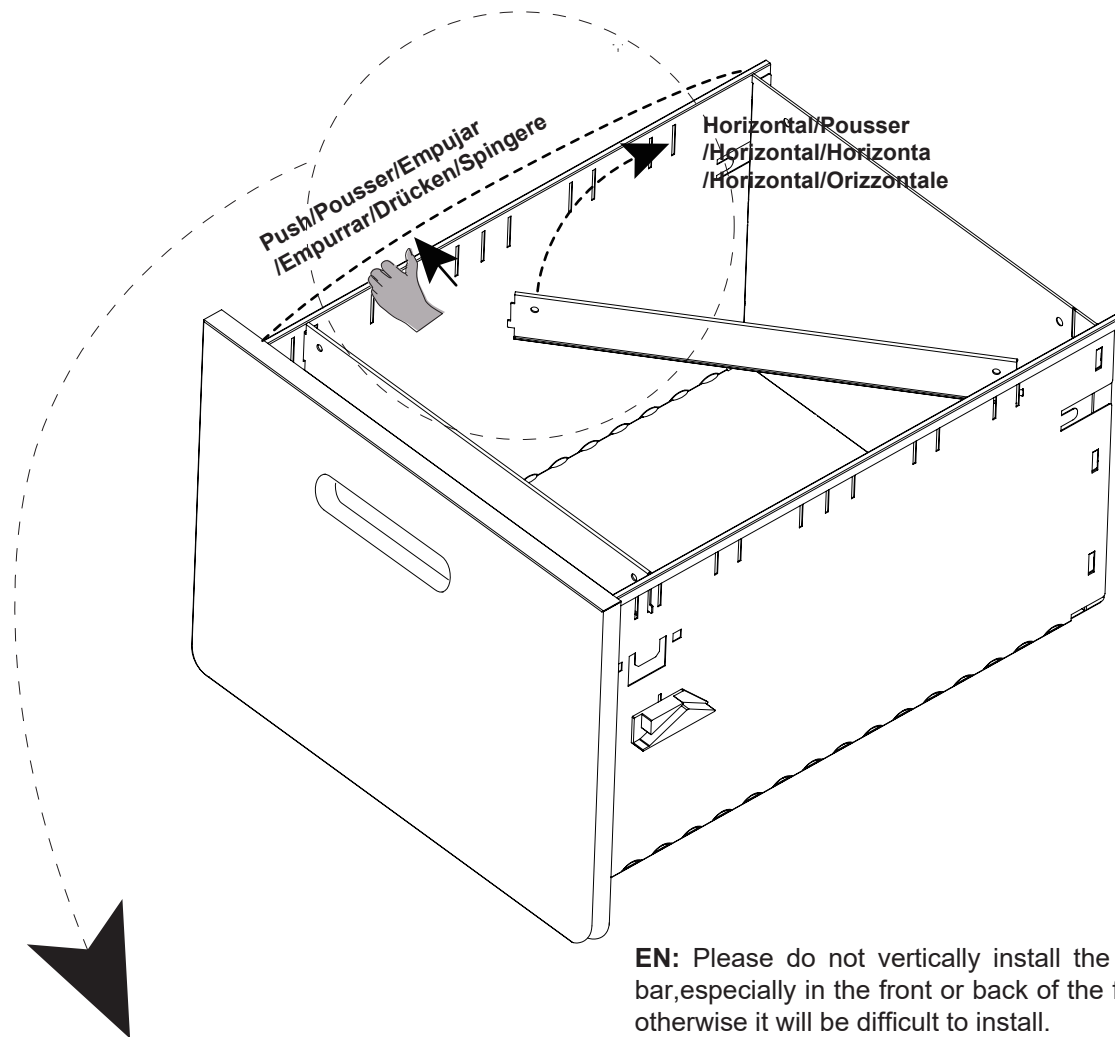

EN: Please do not vertically install the hanging file bar, especially in the front or back of the filing drawer, otherwise it will be difficult to install.

FR: Veuillez ne pas installer verticalement le rail des dossiers suspendus, surtout à l'avant ou à l'arrière du tiroir de classement, sinon il sera difficile de l'installer.

ES: No instale verticalmente la barra de archivo colgante, especialmente en la parte delantera o trasera del cajón de archivo, de lo contrario será difícil de instalar.

PT: Não instale verticalmente a barra de arquivo suspensa, especialmente na parte da frente ou de trás da gaveta de arquivo, caso contrário será difícil de instalar.

DE: Bitte bringen Sie die Hängeregisterstange nicht vertikal an, insbesondere nicht an der Vorder- oder Rückseite der Schublade, da sie sonst nur schwer zu installieren ist.

IT: Si prega di non installare verticalmente la barra per cartelle sospese, specialmente nella parte anteriore o posteriore del cassetto di archiviazione, altrimenti sarà difficile installarla.

US

Imported by Aosom LLC
 27150 SW Kinsman Rd Wilsonville, OR 97070 USA
 MADE IN CHINA

CA

Imported by Aosom Canada Inc.
 7270 Woodbine Avenue, Unit 307, Markham, Ontario Canada
 L3R 4B9
 MADE IN CHINA

Importé par Aosom Canada Inc.
 7270 Woodbine Avenue, unité 307, Markham, Ontario Canada
 L3R 4B9
 Fabriqué en Chine

UK

IMPORTER ADDRESS:
 MH STAR UK LTD
 Unit 27, Perivale Park,
 Horsenden lane South
 Perivale, UB6 7RH
 MADE IN CHINA



FR

ADRESSE D'IMPORTATION:
 MH FRANCE
 2 Rue Maurice Hartmann
 92130 Issy Les Moulineaux
 France
 FABRIQUÉ EN CHINE



FR

Pensez à donner ou recycler.

 Association
 ou
 Magasin
 ou
 Déchèterie

<https://quefairedemesdechets.fr>

ES

IMPORTADOR:
 SPANISH AOSOM, S.L.
 C/ROC GROS, Nº15.08550, ELS HOSTALET DE BALENYÀ, SPAIN.
 B66295775
 WWW.AOSOM.ES
 ATENCIONCLIENTE@AOSOM.ES
 TEL: 931294512
 HECHO EN CHINA

PT

SPANISH AOSOM, S.L
 C.ROC GROS N.15, 08550. ELS HOSTALET DE BALENYÀ
 TEL: 931294512 (SEG-SEX DAS 7:30H ÀS 16:30H)
 INFO@AOSOM.PT
 WWW.AOSOM.PT

DE

ADRESSE DES IMPORTEURE:
 MH Handel GmbH
 Wendenstraße 309
 D-20537 Hamburg
 Germany
 IN CHINA HERGESTELLT

IT

IMPORTATO DA:
 AOSOM Italy srl
 Centro Direzionale Milanofiori
 Strada 1 Palazzo F1
 20057 Assago (MI)
 P.I.: 08567220960
 FATTO IN CINA