

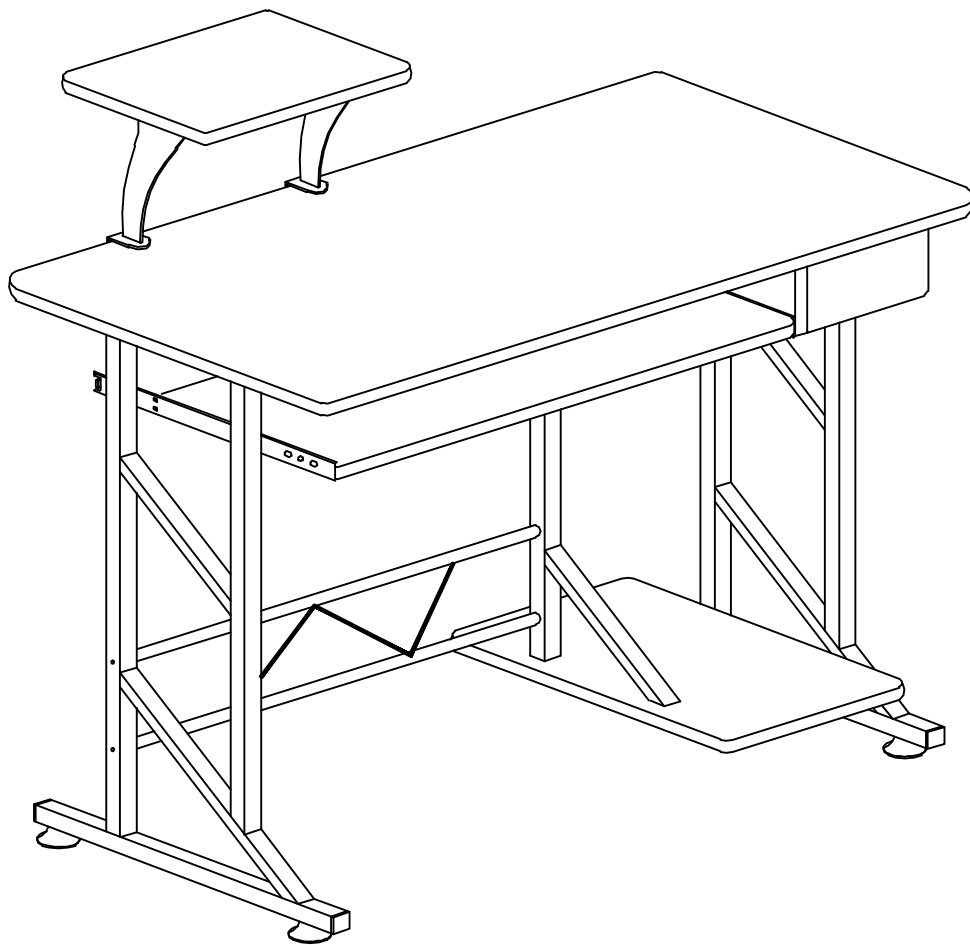

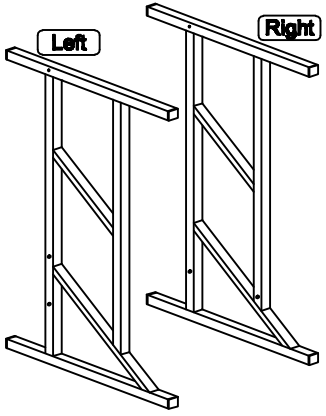

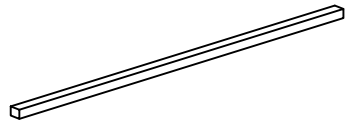

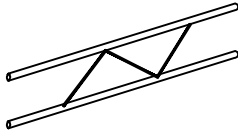

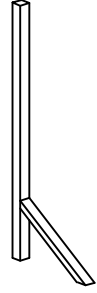
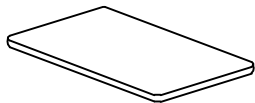
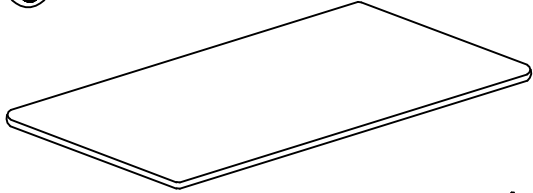
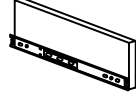
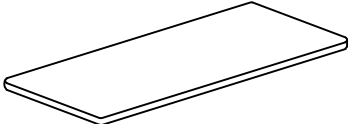
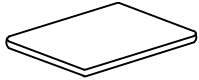
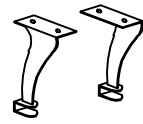

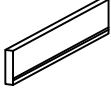

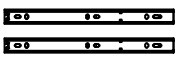

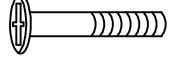
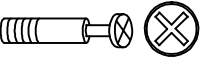
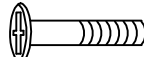
# INSTALLATION INSTRUCTION

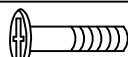

 **NEED TWO PEOPLE INSTALL**

<p>①</p>  <p>Left Right</p> <p>x2</p>	<p>②</p>  <p>x1</p> <p>③</p>  <p>x1</p>	<p>④</p>  <p>x1</p>
<p>⑤</p>  <p>x1</p>	<p>⑥</p>  <p>x1</p>	<p>⑦</p>  <p>x1</p>
<p>⑧</p>  <p>x1</p>	<p>⑨</p>  <p>x1</p>	<p>⑩</p>  <p>x1set</p>
<p>⑪</p>  <p>x1</p>	<p>⑫</p>  <p>x2</p>	<p>⑬</p>  <p>x1</p>
<p>⑭</p>  <p>2.5MDF x1</p>	<p>⑮</p>  <p>x2 set</p>	

PART	QTY	SPEC		PART	QTY	SPEC	
<b>A</b>	3	6x40 MM		<b>G</b>	4	6x35 MM	
<b>B</b>	8	6x35 MM		<b>H</b>	8	4x14 MM	
<b>C</b>	2	6x30 MM		<b>I</b>	4	4x8 MM	
<b>D</b>	4	6x10 MM		<b>J</b>	2		
<b>E</b>	2	5x60 MM		<b>K</b>	4		
<b>F</b>	2	5x50 MM	