

PawHut

IN220900845V01_GL

D51-364V00

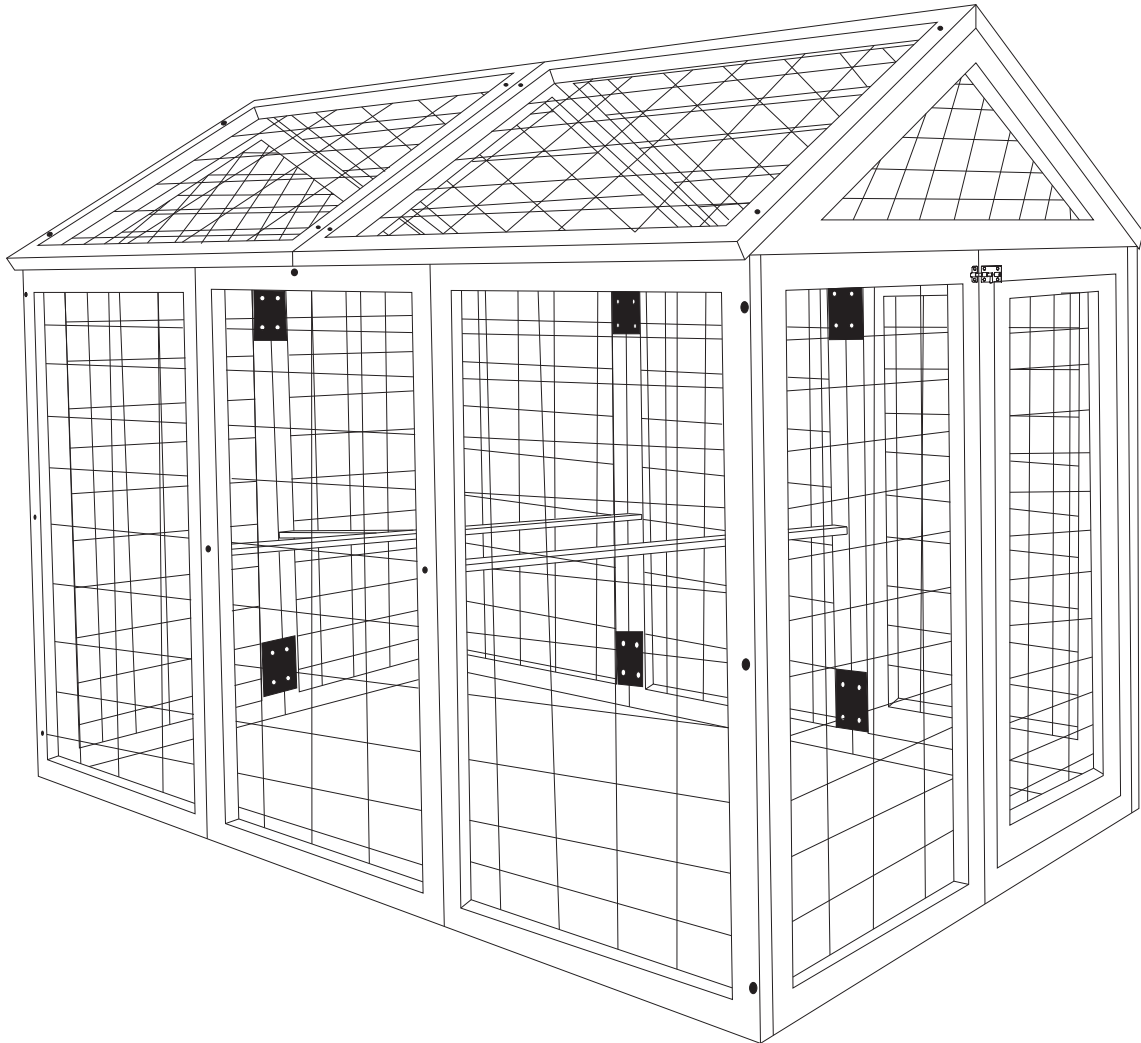

EN_IMPORTANT, RETAIN FOR FUTURE REFERENCE: READ CAREFULLY.

FR_IMPORTANT: A LIRE ATTENTIVEMENT ET À CONSERVER POUR CONSULTATION ULTÉRIEURE.

ES_IMPORTANTE, LEA Y GUARDE PARA FUTURAS REFERENCIAS.

PT_IMPORTANTE, RETER PARA REFERÊNCIA FUTURA: LEIA ATENTAMENTE.

DE_WICHTIG! SORGFÄLTIG LESEN UND FÜR SPÄTER NACHSCHLAGEN AUFBEWAHREN.

IT_IMPORTANTE! CONSERVARE IL PRESENTE MANUALE PER FUTURO RIFERIMENTO E LEGGERLO ATTENTAMENTE.

EN

Dear customer,

Thank you for purchasing this product. So that your appliance serves you well, please read all the instructions in this user's manual. If you have any questions, please contact our customer care center, Our contact details are below:

FR

Cher client,

Nous vous remercions d'avoir acheté ce produit. Afin que vous puissiez profiter pleinement de votre appareil, veuillez lire toutes les instructions de ce manuel d'utilisation. Si vous avez la moindre question, veuillez contacter notre centre d'assistance à la clientèle, Nos coordonnées sont les suivantes:

DE

Sehr geehrter Kunde,

Vielen Dank, dass Sie dieses Produkt erworben haben. Damit Ihr Gerät Ihnen gute Dienste leistet, lesen Sie bitte alle Hinweise in diesem Benutzerhandbuch. Wenn Sie Fragen haben, wenden Sie sich bitte an unser Kundendienstzentrum, Unsere Kontaktdaten stehen unten:

ES

Queridos clientes,

Gracias por comprar este producto. Para que su electrodoméstico le sirva mejor, lea todas las instrucciones de este manual del usuario. Si tiene alguna pregunta, comuníquese con nuestro Centro de Atención al Cliente, Nuestros datos de contacto son los siguientes:

PT

Caros clientes,

Obrigado por adquirir este produto. Para que o seu aparelho o sirva melhor, leia todas as instruções deste manual do utilizador. Se tiver alguma dúvida, por favor contacte o nosso Centro de Atendimento ao Cliente, Os nossos dados de contacto são os seguintes:

IT

Caro Cliente,

Grazie per aver acquistato questo prodotto. Per servirti meglio con questo apparecchio ti prego di leggere tutte le istruzioni in presente manuale utente. In caso di dubbio, si prega di contattare il nostro centro assistenza clienti, I nostri dettagli di contatto sono di seguito:

Country	 Phone	 Email
US	001-877-644-9366	customerservice@aosom.com
CA	416-792-6088	customerservice@aosom.ca
UK	0044-800-240-4004	enquiries@mhstar.co.uk
DE	0049-0(40)-88307530	service@aosom.de
FR	0033-1-84166106	aosom@mhfrance.fr
ES	0034-931294512	atencioncliente@aosom.es
PT	0034-931294512	info@aosom.pt
IT	0039-0249471447	clienti@aosom.it

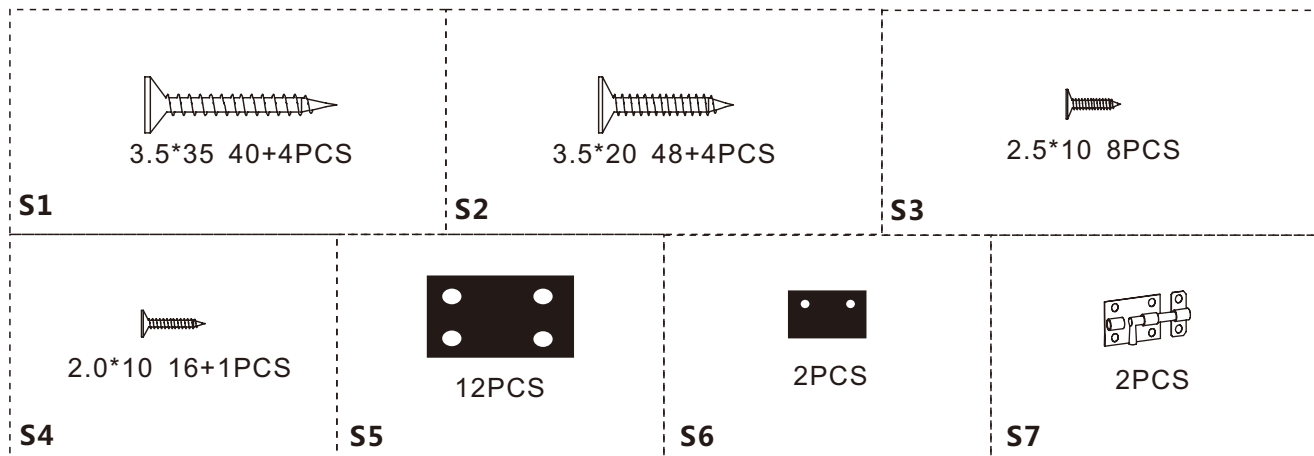
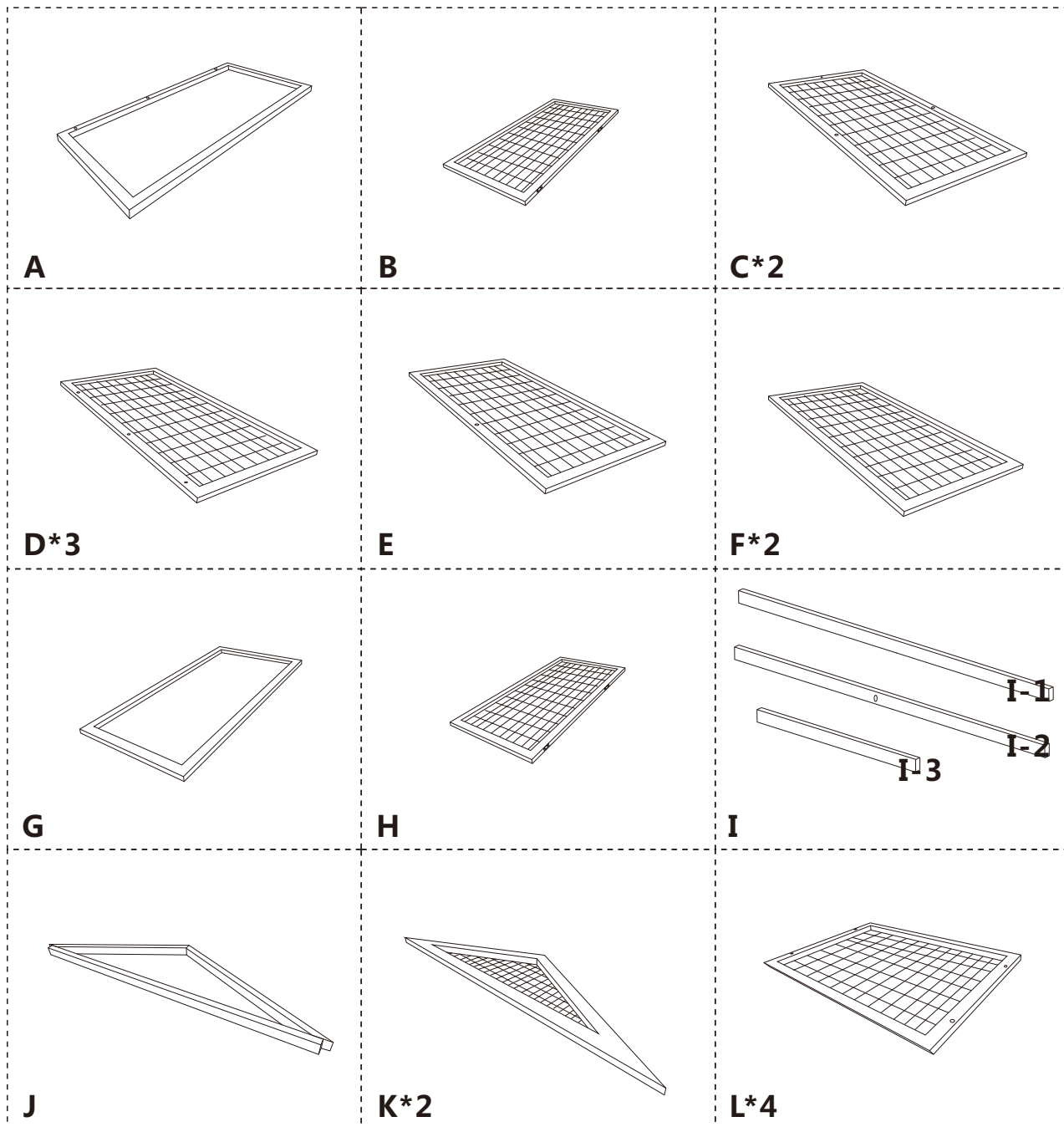

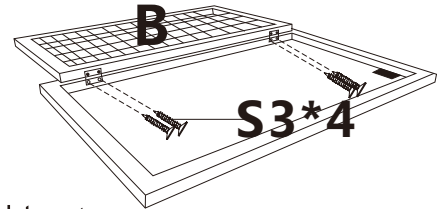
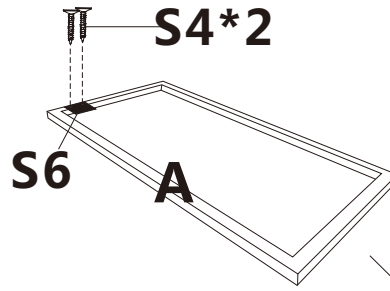
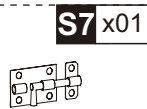
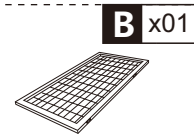
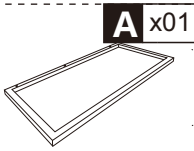

EN Do not confuse similar screws.
FR Ne pas confondre des vis similaires.
ES No confunda tornillos similares.
PT Não confundir parafusos semelhantes.
DE Verwechseln Sie ähnliche Schrauben nicht.
IT Non confondere le viti simili.

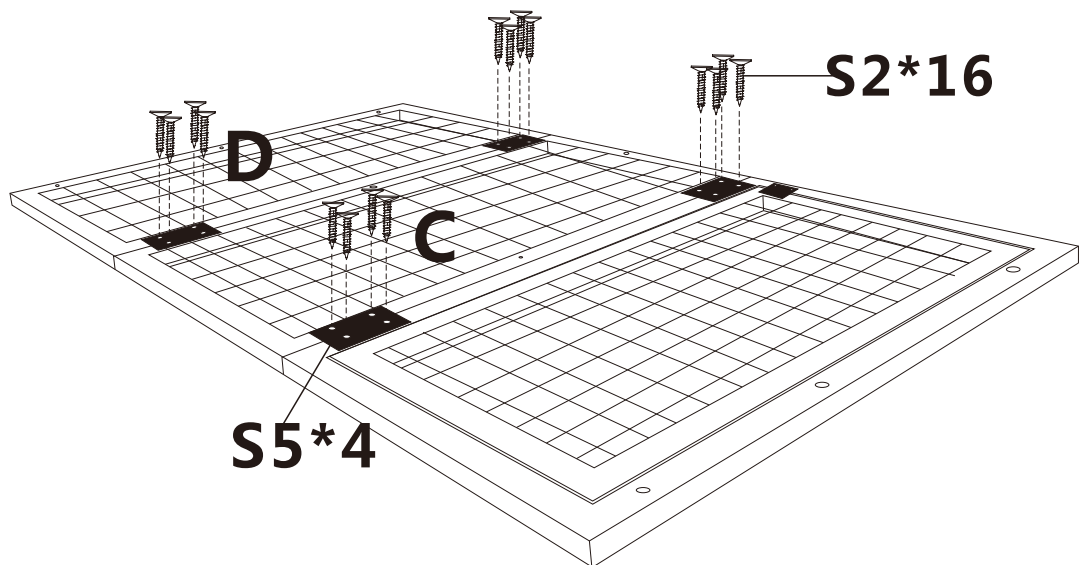
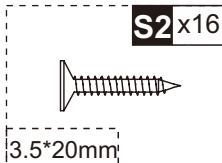
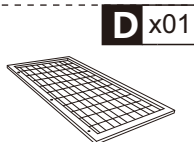
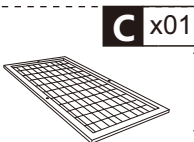
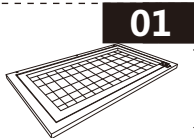
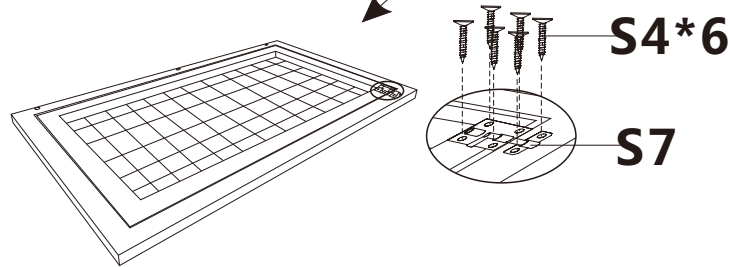

C x01

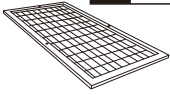

D x02

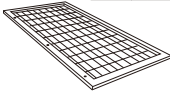

S5 x04



S2 x16



3.5*20mm

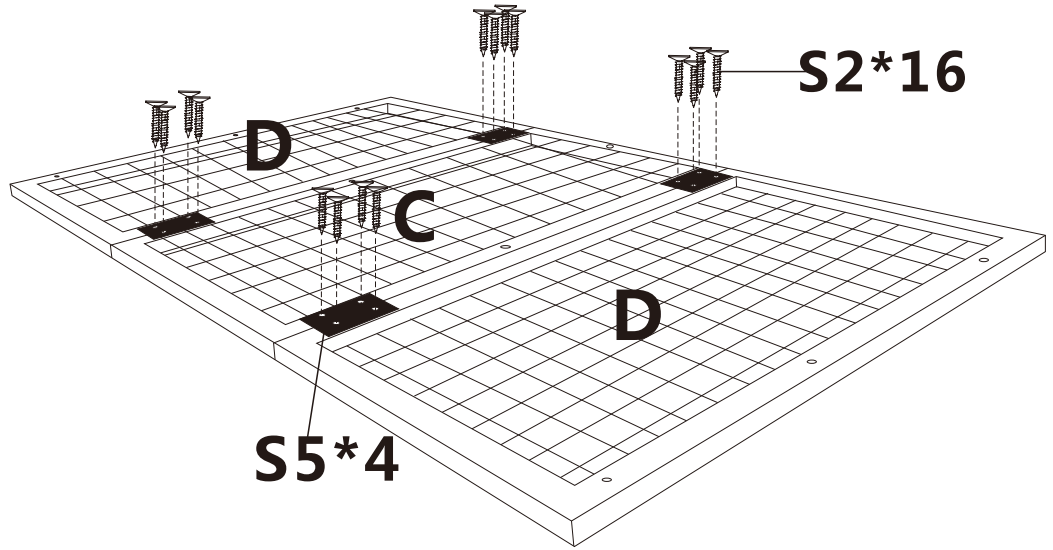

E x01

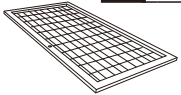

F x01

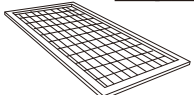

S5 x02



S2 x08



3.5*20mm

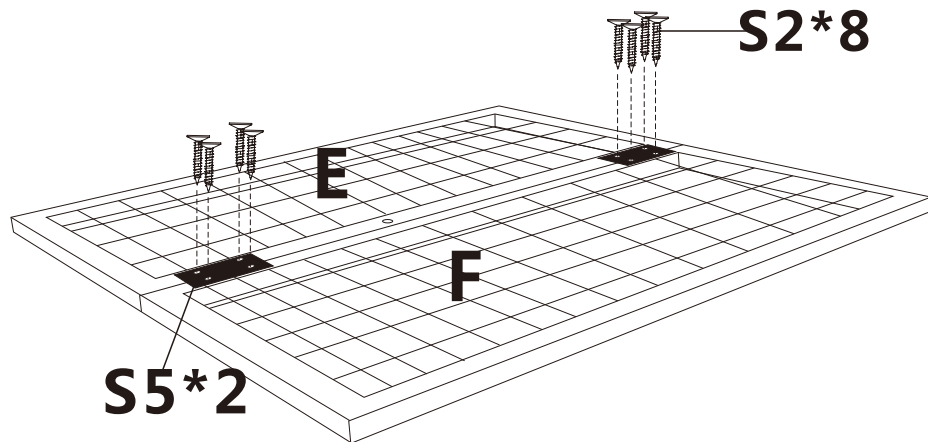

G x01

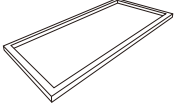

H x01



S6 x01



S7 x01



S3 x04



2.5*10mm

S4 x08



2.0*10mm

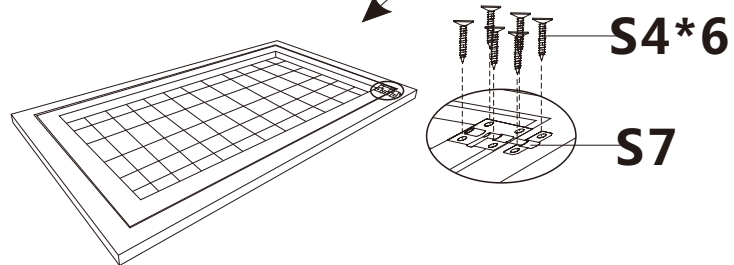
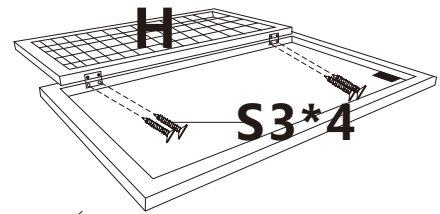
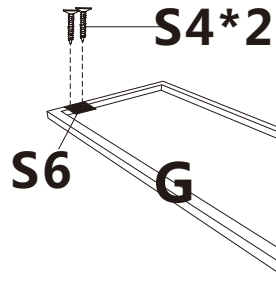

05

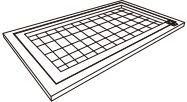

F x01

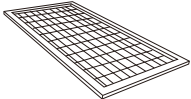

S5 x02



S2 x08



3.5*20mm

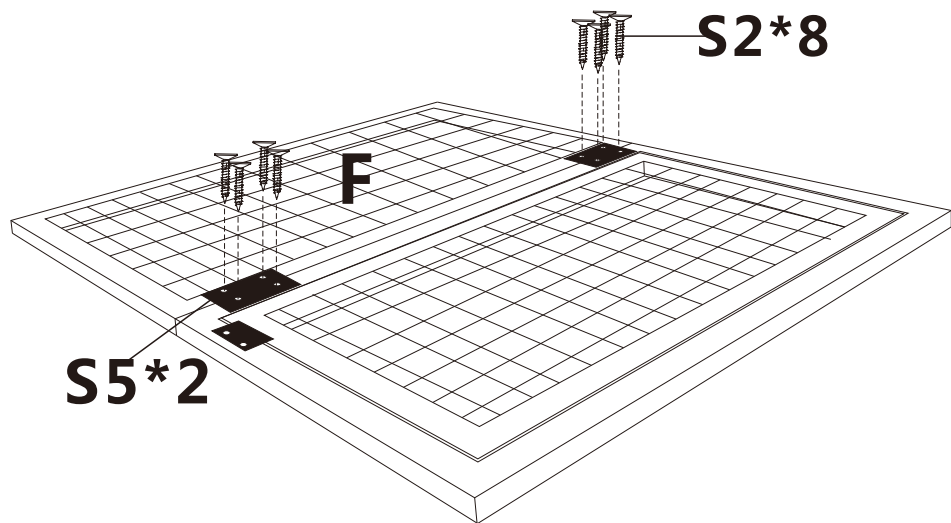

02

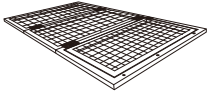

03

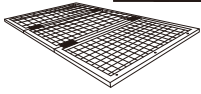

04



S1x06



3.5*35mm

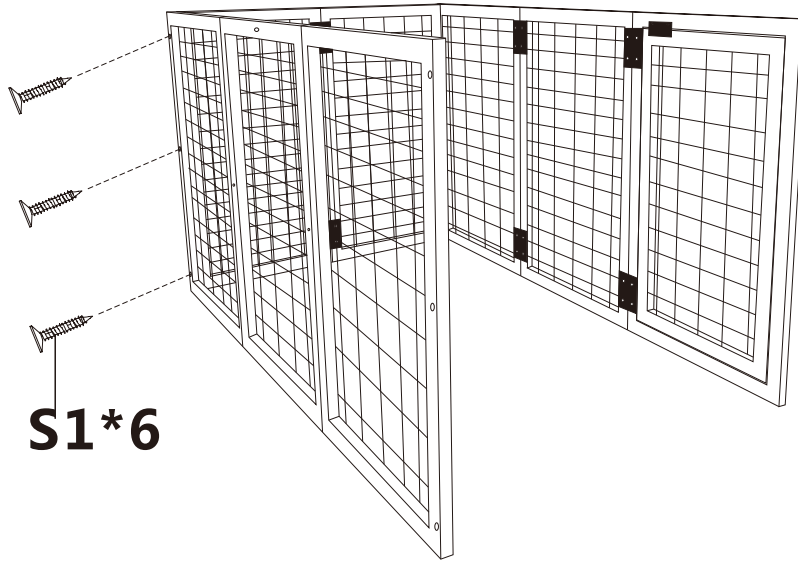

S1*6

06

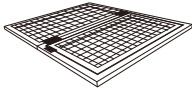

07

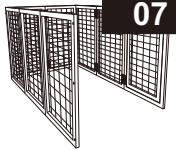

S1x06



3.5*35mm

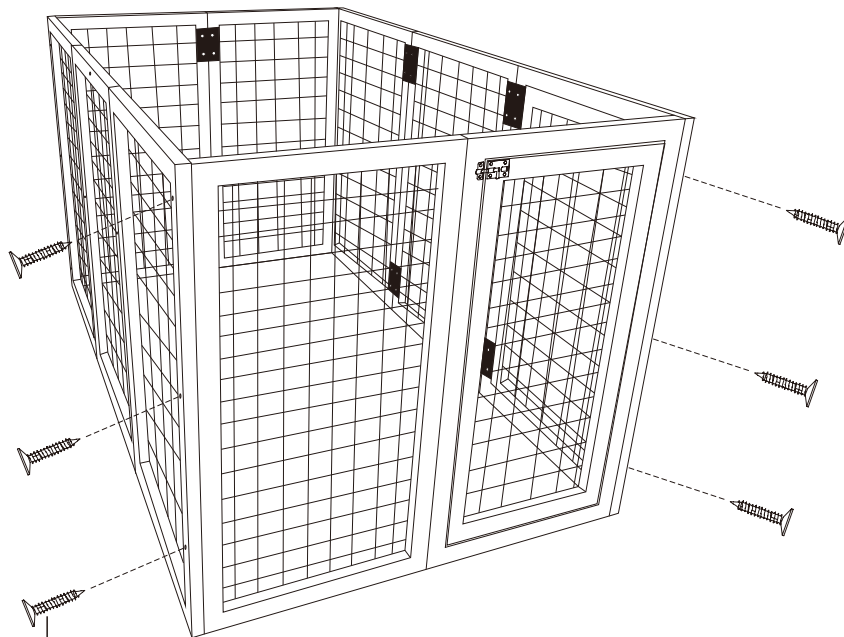

S1*6



08

I x01

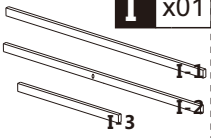

S1 x06



3.5*35mm

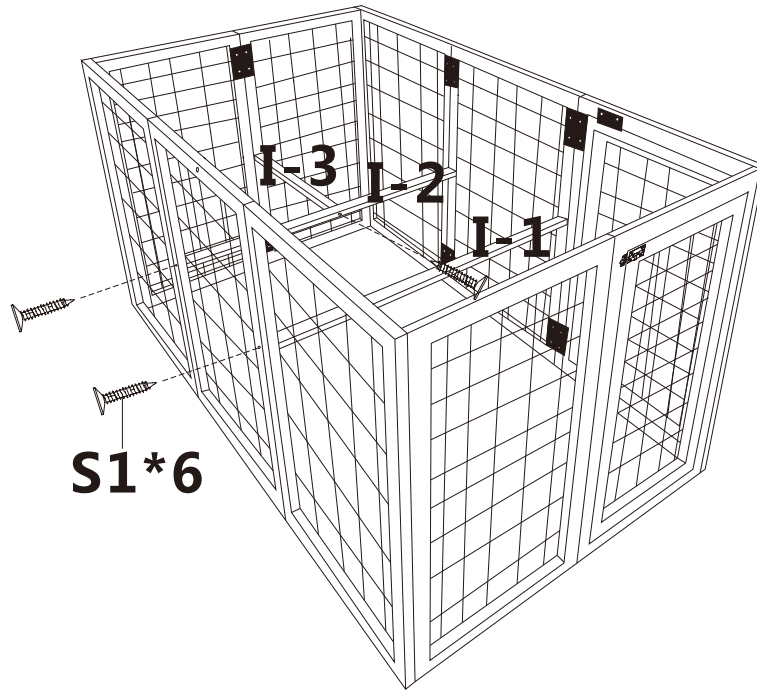

S1*6



09

J x01

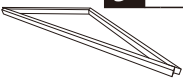

K x02



S1 x06



3.5*35mm

S1*6

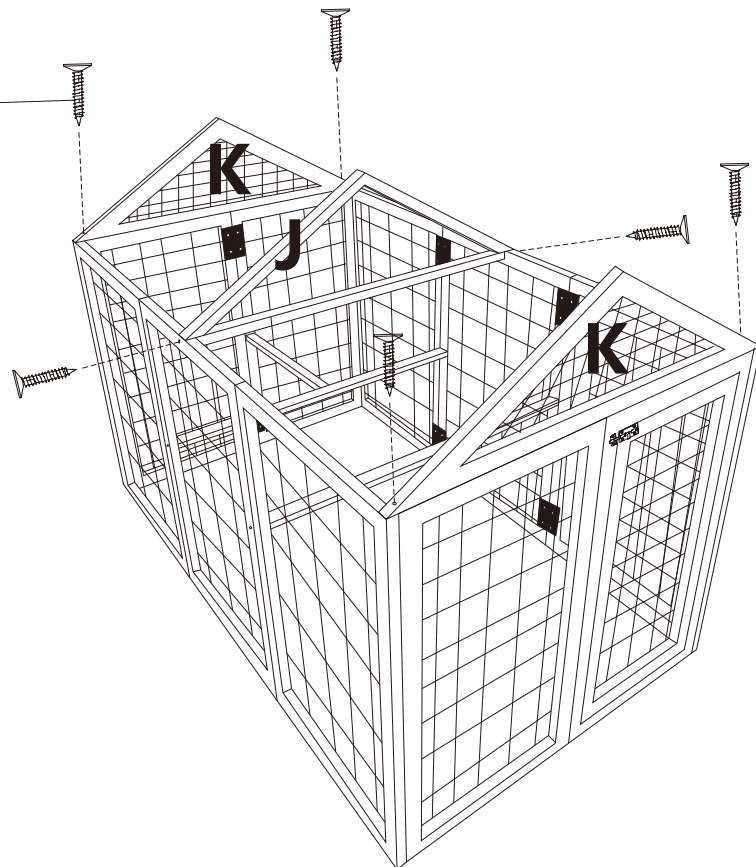

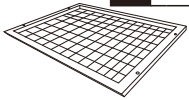
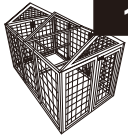

3.5*35mm

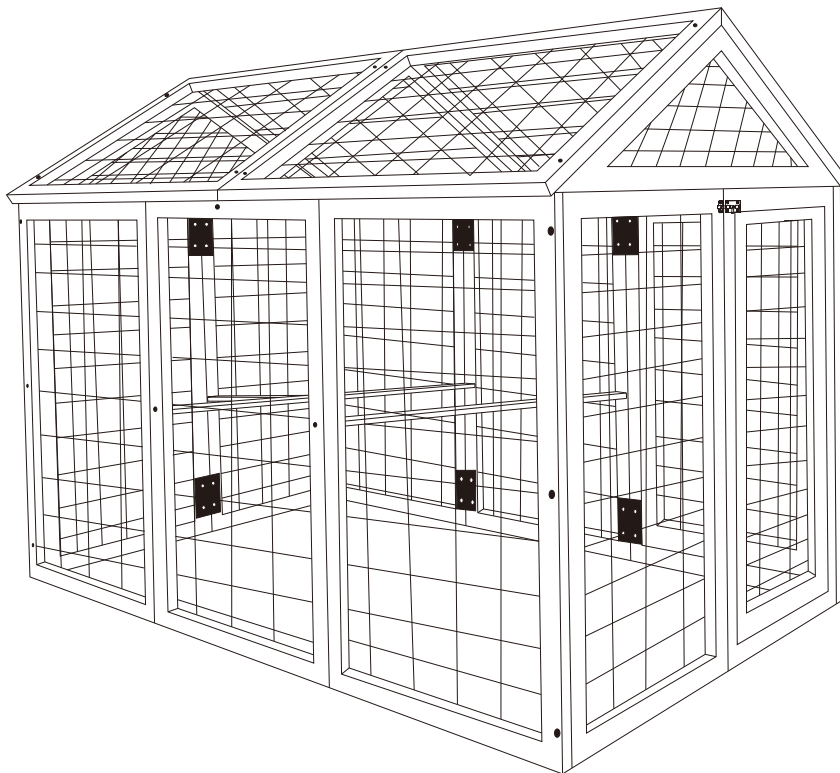
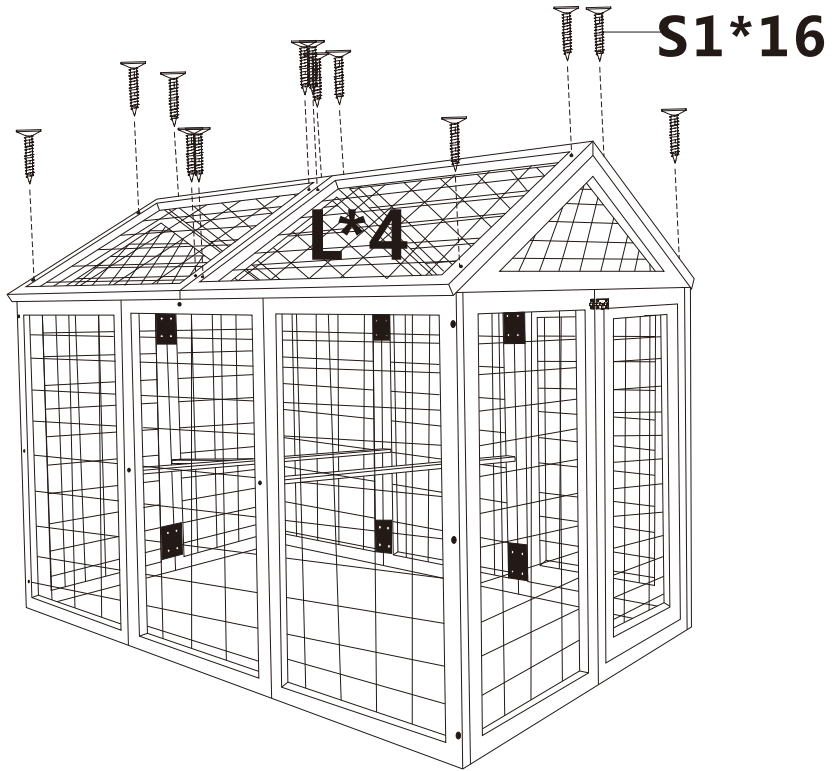

US

Imported by Aosom LLC
 27150 SW Kinsman Rd Wilsonville, OR 97070 USA
 MADE IN CHINA

CA

Imported by Aosom Canada Inc.
 7270 Woodbine Avenue, Unit 307, Markham, Ontario Canada
 L3R 4B9
 MADE IN CHINA

Importé par Aosom Canada Inc.
 7270 Woodbine Avenue, unité 307, Markham, Ontario Canada
 L3R 4B9
 Fabriqué en Chine

UK

IMPORTER ADDRESS:
 MH STAR UK LTD
 Unit 27, Perivale Park,
 Horsenden lane South
 Perivale, UB6 7RH
 MADE IN CHINA

FR

ADRESSE D'IMPORTATION:
 MH FRANCE
 2 Rue Maurice Hartmann
 92130 Issy Les Moulineaux
 France
 FABRIQUÉ EN CHINE



Adresses sur quefairedemesdechets.fr

ES

IMPORTADOR:
 SPANISH AOSOM, S.L.
 C/ROC GROS, Nº15.08550, ELS HOSTALET DE BALENYÀ, SPAIN.
 B66295775
 WWW.AOSOM.ES
 ATENCIONCLIENTE@AOSOM.ES
 TEL: 931294512
 HECHO EN CHINA

PT

SPANISH AOSOM, S.L
 C.ROC GROS N.15, 08550. ELS HOSTALET DE BALENYÀ
 TEL: 931294512 (SEG-SEX DAS 7:30H ÀS 16:30H)
 INFO@AOSOM.PT
 WWW.AOSOM.PT

DE

ADRESSE DES IMPORTEURE:
 MH Handel GmbH
 Wendenstraße 309
 D-20537 Hamburg
 Germany
 IN CHINA HERGESTELLT

IT

IMPORTATO DA:
 AOSOM Italy srl
 Centro Direzionale Milanofiori
 Strada 1 Palazzo F1
 20057 Assago (MI)
 P.I.: 08567220960
 FATTO IN CINA