



Children's scooter 5 IN 1

*Suitable for children of 1-8 years old.

*Max weight: 60 kg.



IMPORTANT, RETAIN FOR FUTURE REFERENCE: READ CAREFULLY

ASSEMBLY INSTRUCTION

Dear customer,

Thank you for purchasing this product. So that your appliance serves you well, please read all the instructions in this user's manual. If you have any questions, please contact our customer care center.

Our contact details are below:

Country	 Phone	 Email
UK	0044-800-240-4004	enquiries@mhstar.co.uk

IMPORTER ADDRESS:

*MH STAR UK LTD
Unit 27, Perivale Park,
Horsenden lane South
Perivale, UB6 7RH*

MADE IN CHINA

A x 1



B x 1



C x 1



D x 1



E x 1



F x 1



G x 1

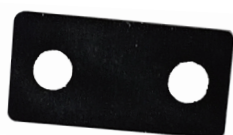

H x 1



I x 1



J x 1



K x 1



L x 6



M x 1



N x 1



O x 1



P x 1



Q x 1



01

E x 1

F x 1

G x 1

J x 1

L x 4

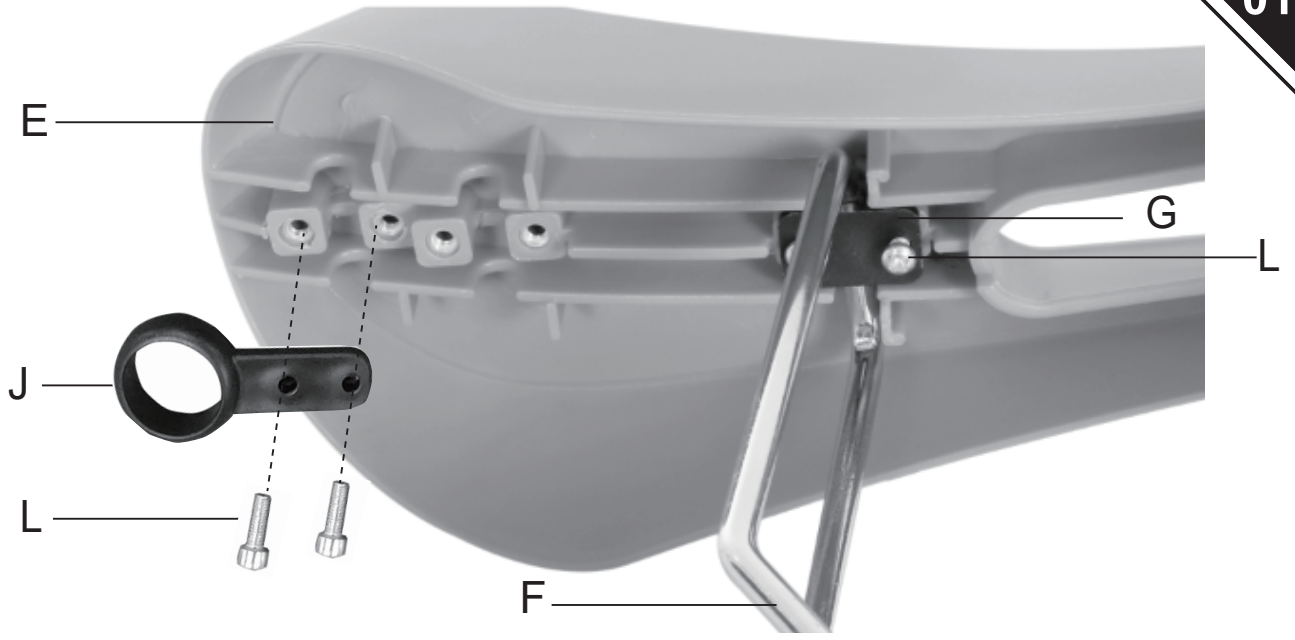

02

D x 1

H x 1

I x 1

L x 2

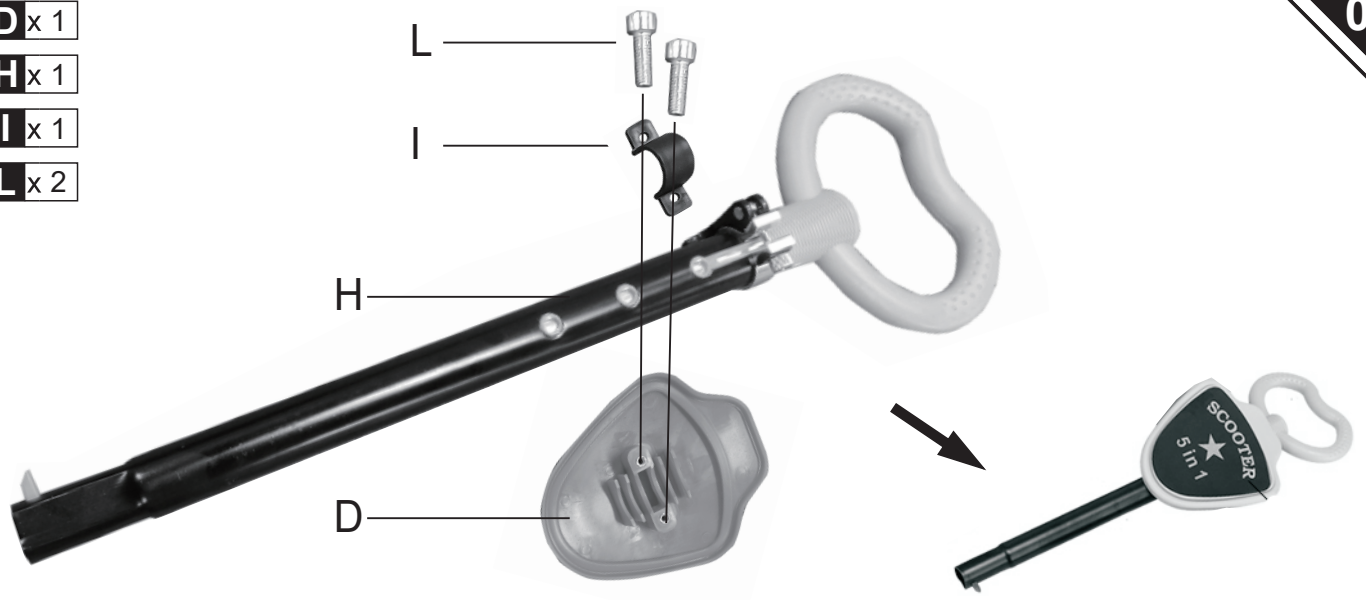

03

A x 1

C x 1

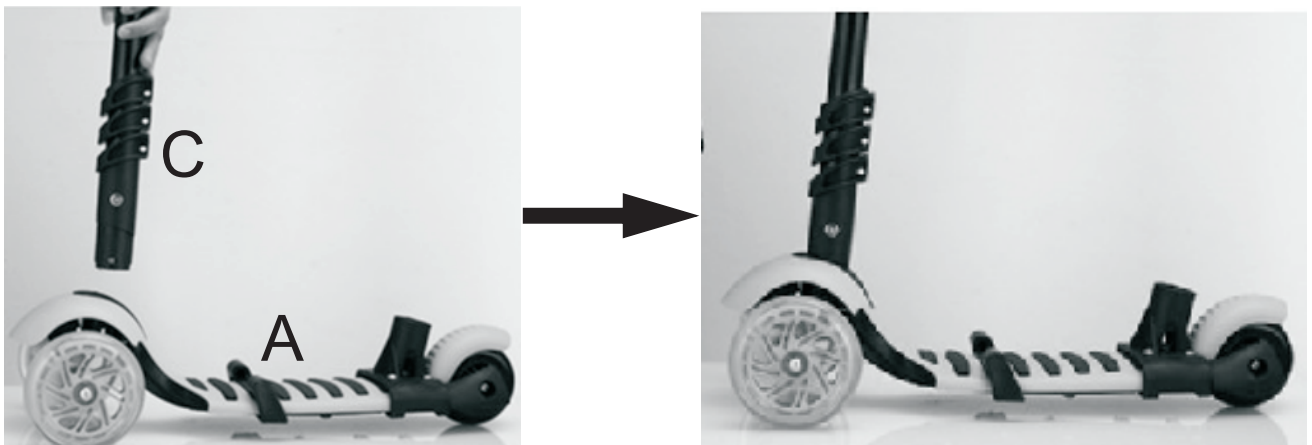



O x 1

P x 1

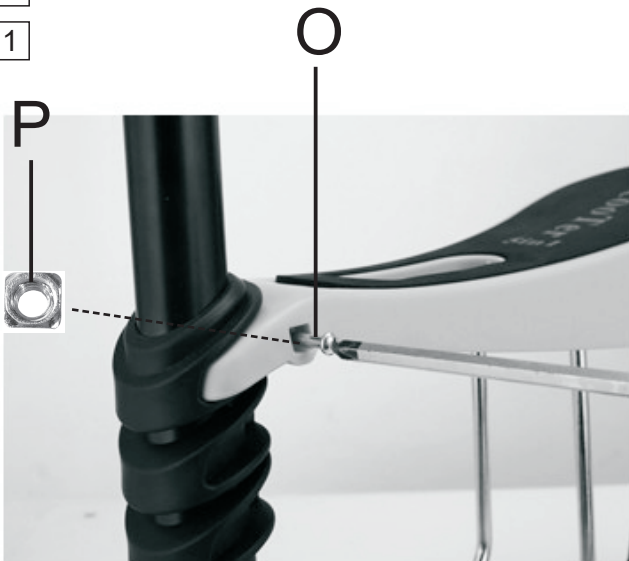

B x 1 **M** x 1

K x 1 **N** x 1

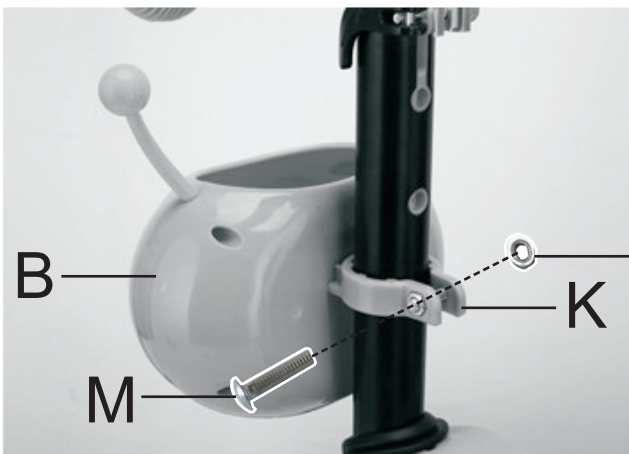

Congratulations on purchasing this scooter. Read the instruction manual carefully before starting ride. It contains important safety requirements and comprehensive instructions for use and maintenance. Save the guide for the future so you can check back later. We wish you a pleasant ride!

SAFETY REQUIREMENTS

1. Before let your child ride, make sure that it is securely assembled: the steering pipe is properly secured in a designated area, all screws are firmly tightened. Also check the reliability of the wheel attachment and be sure that there are no rubbing marks that could cause the break. Before each ride, the scooter must be thoroughly checked by an adult.
2. Attention! A pedestrian must wear appropriate personal protective equipment such as a cyclist helmet, protective palms, elbows and road shields, and wear shoes with rubber boots.
3. Do not allow children to ride on steep slopes. The pick up brake is not suitable for stopping at high speed.
4. The brakes become hot when the brakes are stopped. Do not let the children press the brake for long periods of time or operate the brake. Explain that contact with the hot brake can cause severe burns on the skin.
5. Do not let children ride at speeds greater than 5 km / h. Roads, gravel roads and other motorized traffic areas.
6. Adhere to the traffic rules strictly. Do not go for a walk on public roads.
7. Only one person can go on a scooter one day.
8. Do not ride through the dark at night or in low visibility conditions.
9. Do not run on a scooter under wet conditions.
10. Teach your child to ride a new scooter. Make sure he will not be lagging behind the scooter, irresponsibly and will avoid risky maneuvers. Match the driving pattern to your child's experience.
11. Do not attempt to change the fitting design. In this way, the right to warranty service is lost.
12. Maximum weight for a rider: 60 kg.
13. Attention! Retightening the axle screws several times reduces their locking properties. This means that they can relax in their own way. Be sure to be sure of tightening these bolts.

WARNINGS

1. Before riding a scooter, make sure the steering wheel is securely locked.
2. This scooter, by the way, all rollers, skateboards, bikes, and so on. Absolutely safe sporting equipment is not available. Even in perfect condition such inventory poses a certain risk of use.
3. When riding this scooter, always wear a safety helmet. Crash from a helmet without a helmet can cause serious or even fatal injuries. Attention! Wear personal protective equipment.
4. Do not run scratchy in rainy weather or wet with wet weather.
5. Do not scoot around during dark days or in low visibility situations, as this behavior can lead to serious crashes and severe injuries.
6. Always wear specified personal protective equipment. In addition, it is recommended to wear a vivid and reflective vest.
7. Attention! The brake is heavily heated during braking.
8. Attention! There are small parts.
9. Maximum child weight: up to 60 kg.
10. Suit for the max body height: 105cm

1. Drive responsibly. Nutrition and collisions can be the cause of injury to a rider or other person.
2. For a long time, some parts of it may be covered by a rust layer after a certain period of time.
In most cases, this happens when you continue to ride around the water bodies and leave the scooter for a long time outdoors.

MAINTENANCE

Regularly check the tightening of the bolts and the technical condition of the wheels. When you notice that the wheels are worn, replace them with new ones. When you have finished riding, scrub with a damp cloth.

COLLECTION

1. Remove the pedal and lever
2. Insert T-shaped steering wheel, press firmly.
3. First, align the base bracket according to the seat's future position.
4. Insert the seat bracket into the screwed base bracket. Insert the seat in front of the T- shaped steering socket and secure it
5. Tighten the seat bolt with the bolt
6. Fasten the black holder by inserting it into the fitted cavity at the base of the scooter.
7. Insert the rear handle, press firmly.
8. Tighten the plastic sheet in a semicircle with screws.
9. Fasten the basket to the T-shaped steering wheel.
10. Collection complete.



Trottinette pour enfants 5 IN

*Convient aux enfants de 1 à 8 ans.

*Poids maximum : 60 kg.



IMPORTANT : A lire attentivement et à conserver pour consultation ultérieure

MANUEL D'INSTRUCTION

Cher client,

Nous vous remercions d'avoir acheté ce produit. Afin que vous puissiez profiter pleinement de votre appareil, veuillez lire toutes les instructions de ce manuel d'utilisation. Si vous avez la moindre question, veuillez contacter notre centre d'assistance à la clientèle.

Nos coordonnées sont les suivantes:

Pays	 Téléphone	 Email
FR	0033-1-84166106	aosom@mhfrance.fr

ADRESSE D'IMPORTATION:

*MH FRANCE
2 Rue Maurice Hartmann
92130 Issy Les Moulineaux
France*

FABRIQUÉ EN CHINE

A x 1



B x 1



C x 1



D x 1



E x 1



F x 1



G x 1

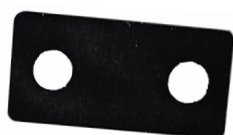

H x 1



I x 1



J x 1



K x 1



L x 6



M x 1



N x 1



O x 1



P x 1



Q x 1



01

E x 1

F x 1

G x 1

J x 1

L x 4

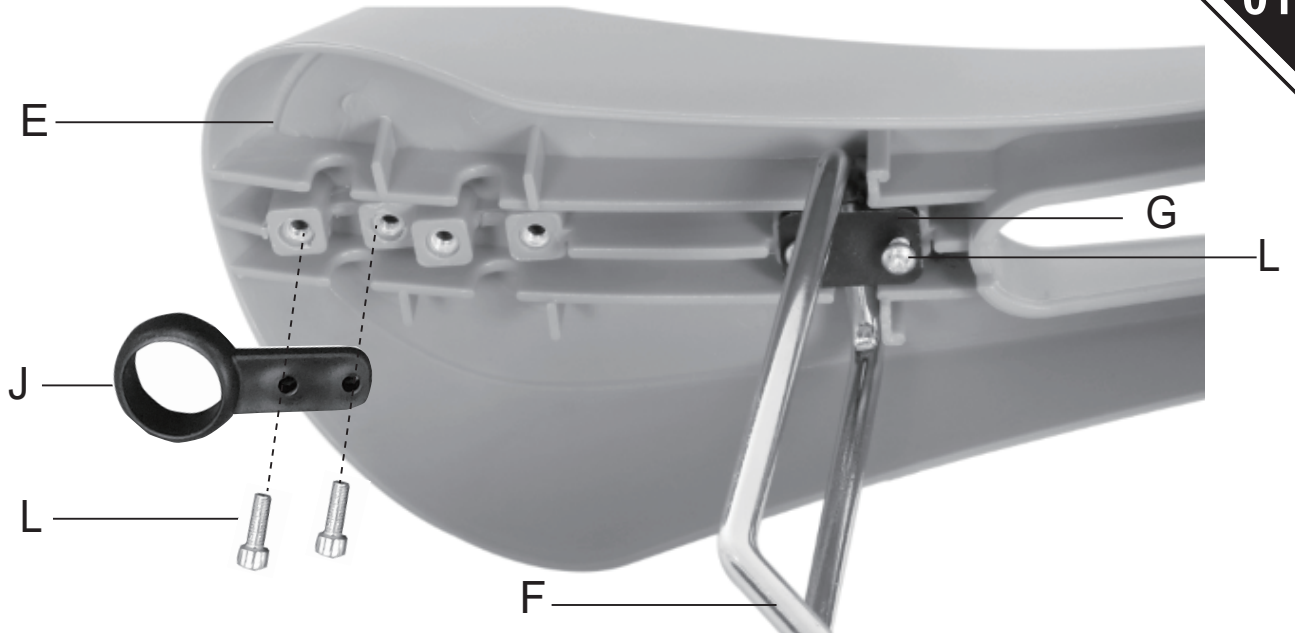

02

D x 1

H x 1

I x 1

L x 2

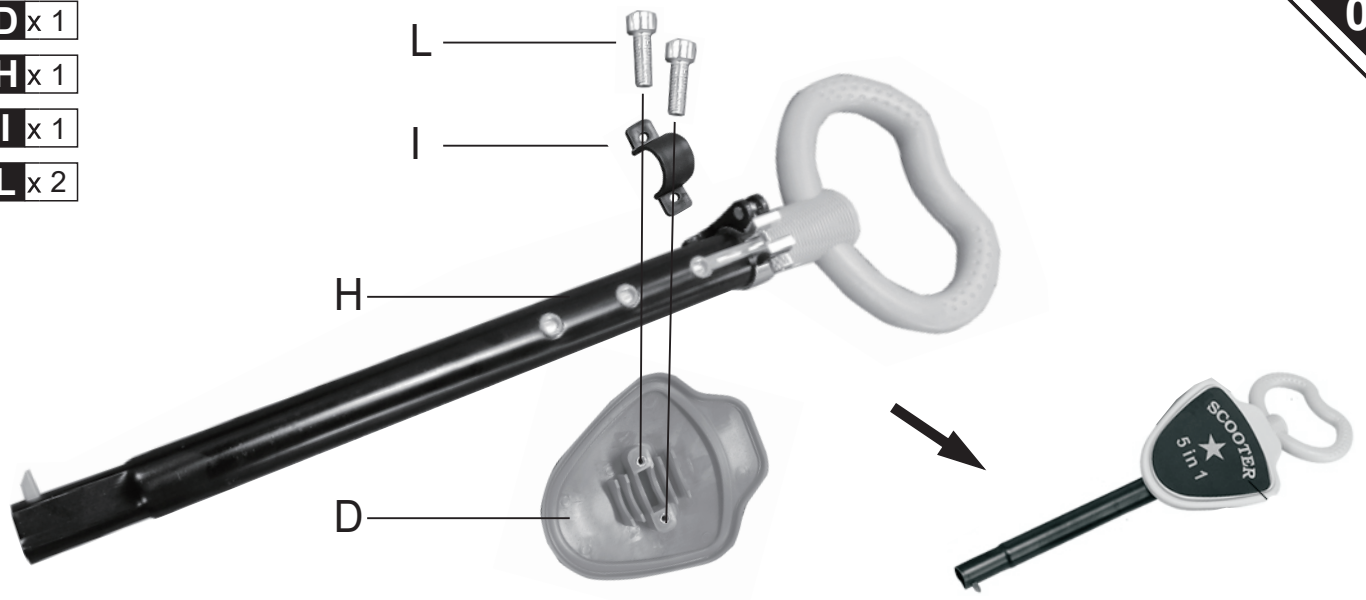

03

A x 1

C x 1

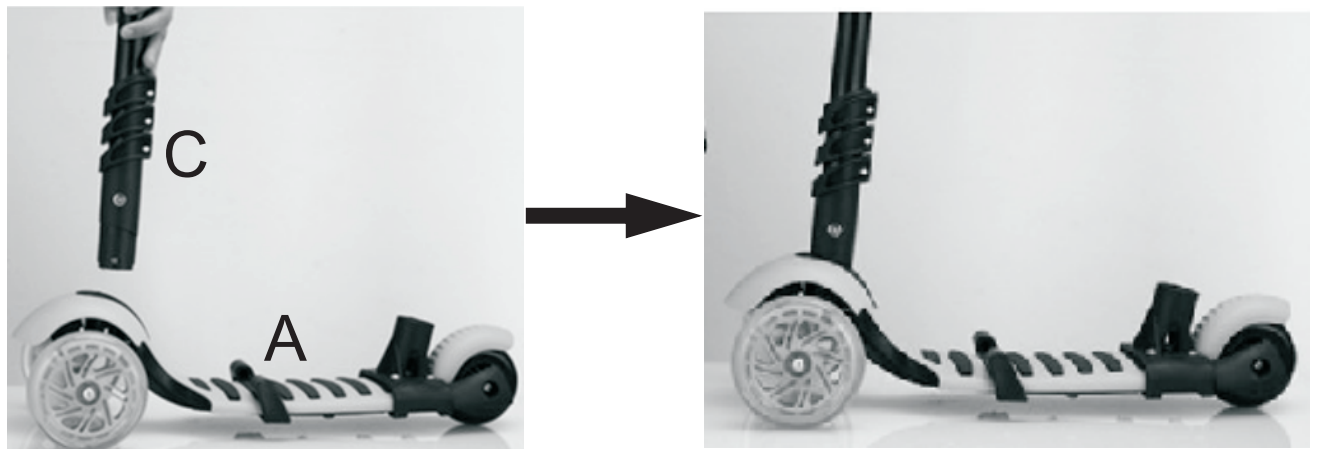



O x 1

P x 1

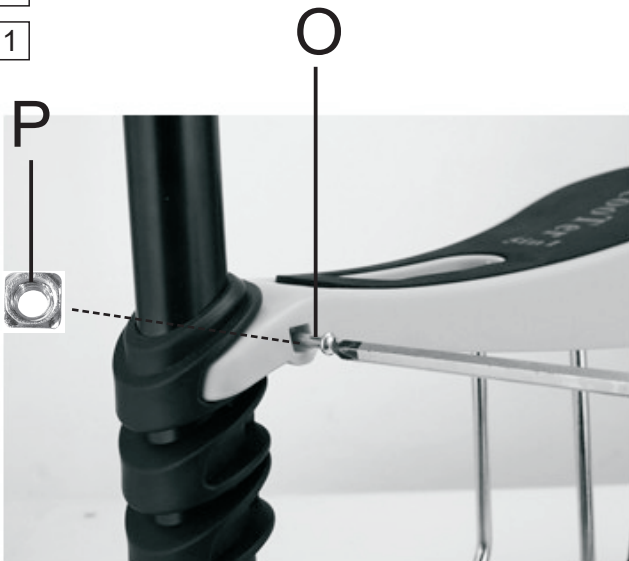

B x 1 **M** x 1

K x 1 **N** x 1

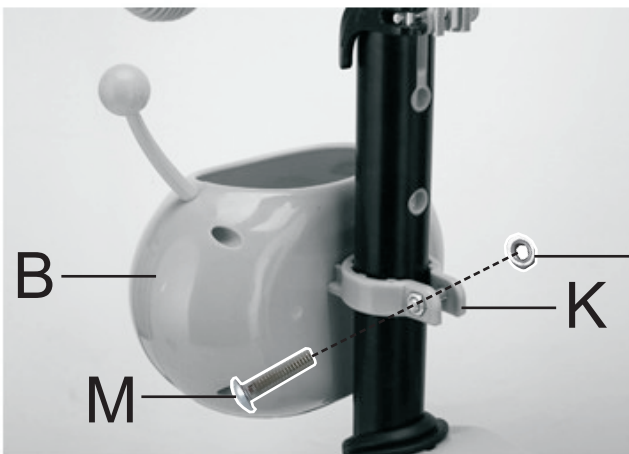

Lisez attentivement le manuel d'instructions avant de commencer. Il contient des consignes de sécurité importantes et des instructions complètes pour l'utilisation et l'entretien. Conservez le guide pour référence ultérieure afin que vous puissiez vérifier plus tard. Nous vous souhaitons un agréable tour!

EXIGENCES EN MATIÈRE DE SÉCURITÉ

1. Avant de laisser votre enfant monter, assurez-vous qu'il est solidement assemblé: le tuyau de direction est correctement fixé dans une zone désignée, toutes les vis sont fermement serrées.
Vérifiez également la fiabilité de la fixation de roue et assurez-vous qu'il n'y a pas de marques de frottement qui pourraient causer la rupture. Avant chaque trajet, le trottinette doit être soigneusement vérifié par un adulte.
2. Attention! Un piéton doit porter l'équipement de protection individuelle approprié comme un casque de cycliste, des paumes de protection, des coudes et des boucliers routiers, et porter des chaussures avec des bottes en caoutchouc.
3. Ne laissez pas les enfants rouler sur des pentes raides.
4. Les freins deviennent chauds lorsque les freins sont arrêtés. Ne laissez pas les enfants appuyer sur le frein pendant de longues périodes ou actionner le frein. Expliquez que le contact avec le frein chaud peut causer de graves brûlures sur la peau.
5. Ne laissez pas les enfants rouler à des vitesses supérieures à 5 km/h sur les routes, routes de gravier et autres zones de circulation motorisée.
6. Respectez strictement les règles de circulation. Ne vous promenez pas sur la voie publique.
7. Une seule personne peut monter le trottinette un jour.
8. Ne conduisez pas ce trottinette dans l'obscurité la nuit ou dans des conditions de faible visibilité.
9. Ne conduisez pas un trottinette dans des conditions humides.
10. Enseignez à votre enfant à monter un nouveau trottinette. Faites correspondre le modèle de conduite à l'expérience de votre enfant.
11. N'essayez pas de modifier la conception de montage. De cette façon, le droit au service de garantie est perdu.
12. Poids maximum pour un joueur : 60 kg.
13. Attention! Resserrez les vis d'essieu réduit plusieurs eurs propriétés de verrouillage. Cela signifie qu'ils peuvent se détendre. Assurez-vous d'être sûr de serrer bien ces boulons.

AVERTISSEMENTS

1. Avant de conduire un scooter, Veuillez à ce que le volant soit verrouillé en toute sécurité.
2. Lorsque vous conduisez ce trottinette, portez toujours un casque de sécurité. L'écrasement d'un casque sans casque peut causer des blessures graves, voire mortelles. Attention! Portez de l'équipement de protection individuelle.
3. Ne conduisez pas par temps pluvieux ou mouillé.
4. Ne vous déplacez pas pendant les jours sombres ou dans des situations de faible visibilité, car ce comportement peut entraîner de graves accidents et des blessures graves.
5. Portez toujours un équipement de protection individuelle spécifié. En outre, il est recommandé de porter un gilet vif et réfléchissant.
6. Attention! Le frein est fortement chauffé pendant le freinage.
7. Attention! Il y a de petites pièces.
8. Poids maximum de l'enfant : jusqu'à 60 kg.

9. Conduisez de façon responsable. La nutrition et les collisions peuvent être la cause de blessures pour un cycliste ou une autre personne.

10. Pendant longtemps, certaines parties de celui-ci peuvent être recouvertes d'une couche de rouille après une certaine période de temps. Dans la plupart des cas, cela se produit lorsque vous continuez à rouler autour des plans d'eau et à laisser le scooter pendant une longue période à l'extérieur.

ENTRETIEN

Vérifiez régulièrement le serrage des boulons et l'état technique des roues. Lorsque vous remarquez que les roues sont usées, remplacez-les par de nouvelles. Lorsque vous avez fini de rouler, frottez avec un chiffon humide.

Collection

1. Retirez la pédale et le levier
2. Insérez le volant en forme de T, appuyez fermement.
3. Tout d'abord, alignez le support de base en fonction de la position future du siège.
4. Insérez le support de siège dans le support de base vissé.
Insérez le siège devant le volant de direction en forme de T et fixez-le.
5. Resserrez le boulon de siège avec le boulon.
6. Fixez le support noir et insérez-le dans la cavité ajustée à la base du scooter.
7. Insérez la poignée arrière, appuyez fermement.
8. Resserrez la feuille en plastique dans un demi-cercle avec des vis.
9. Fixez le panier au volant en forme de T.
10. Collecte complète.

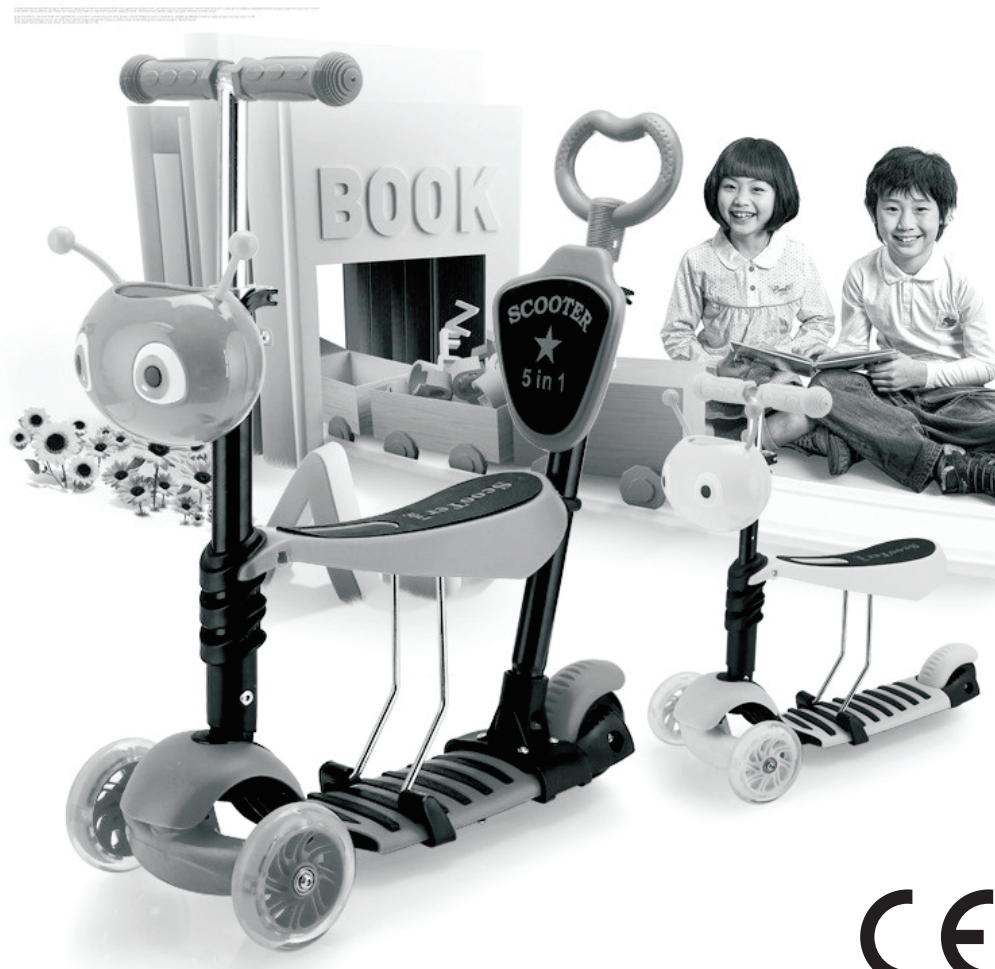

Scooter para Niños 5 EN 1

*Adecuado para los niños de 1 a 8 años.

*Peso máximo: 60 kg.



IMPORTANTE - CONSERVE ESTA INFORMACIÓN
PARA SU CONSULTA POSTERIOR: LEER DETALLADAMENTE

INSTRUCCIONES DE MONTAJE

Queridos clientes,

Gracias por comprar este producto. Para que su electrodoméstico le sirva mejor, lea todas las instrucciones de este manual del usuario. Si tiene alguna pregunta, comuníquese con nuestro Centro de Atención al Cliente.

Nuestros datos de contacto son los siguientes:

País	 Teléfono	 Correo electrónico
ES	0034-931294512	atencioncliente@aosom.es

IMPORTADOR:

*Spanish Aosom, S.L.
C/ Roc Gros, nº 15.
08550, Els Hostalets de Balenyà, Spain.
B66295775
www.aosom.es
atencioncliente@aosom.es
TEL: 931294512*

HECHO EN CHINA

A x 1



B x 1



C x 1



D x 1



E x 1



F x 1

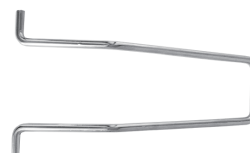

G x 1



H x 1



I x 1



J x 1



K x 1



L x 6



M x 1



N x 1



O x 1



P x 1



Q x 1



01

E x 1

F x 1

G x 1

J x 1

L x 4

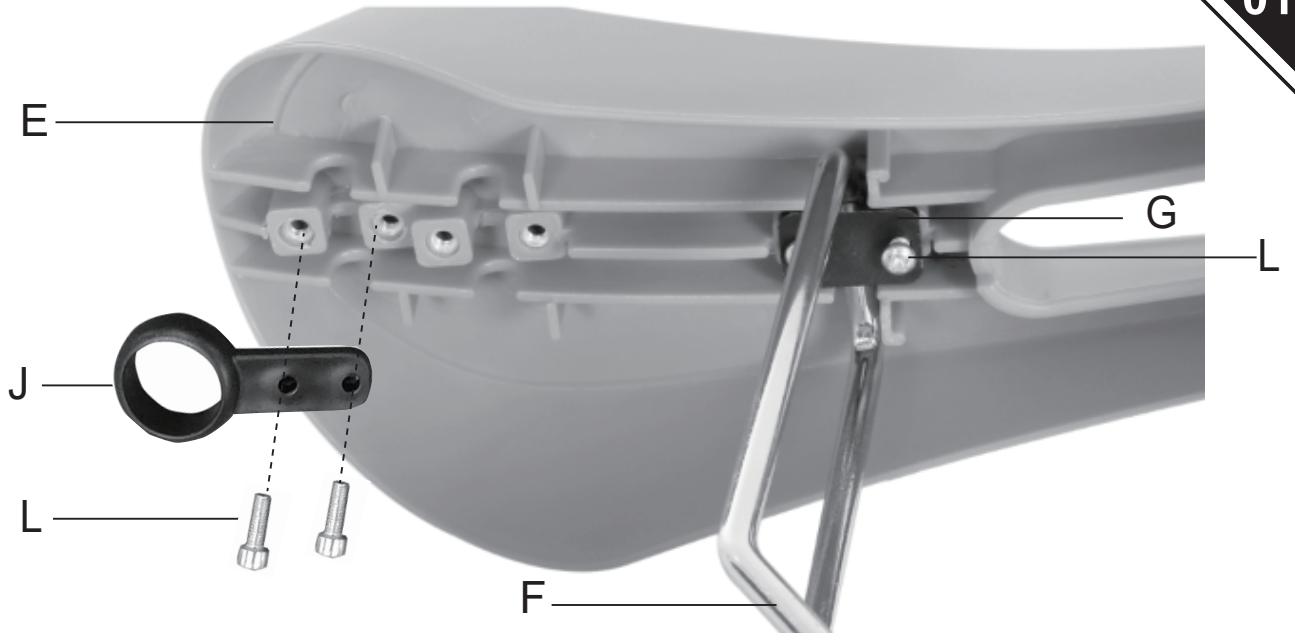

02

D x 1

H x 1

I x 1

L x 2

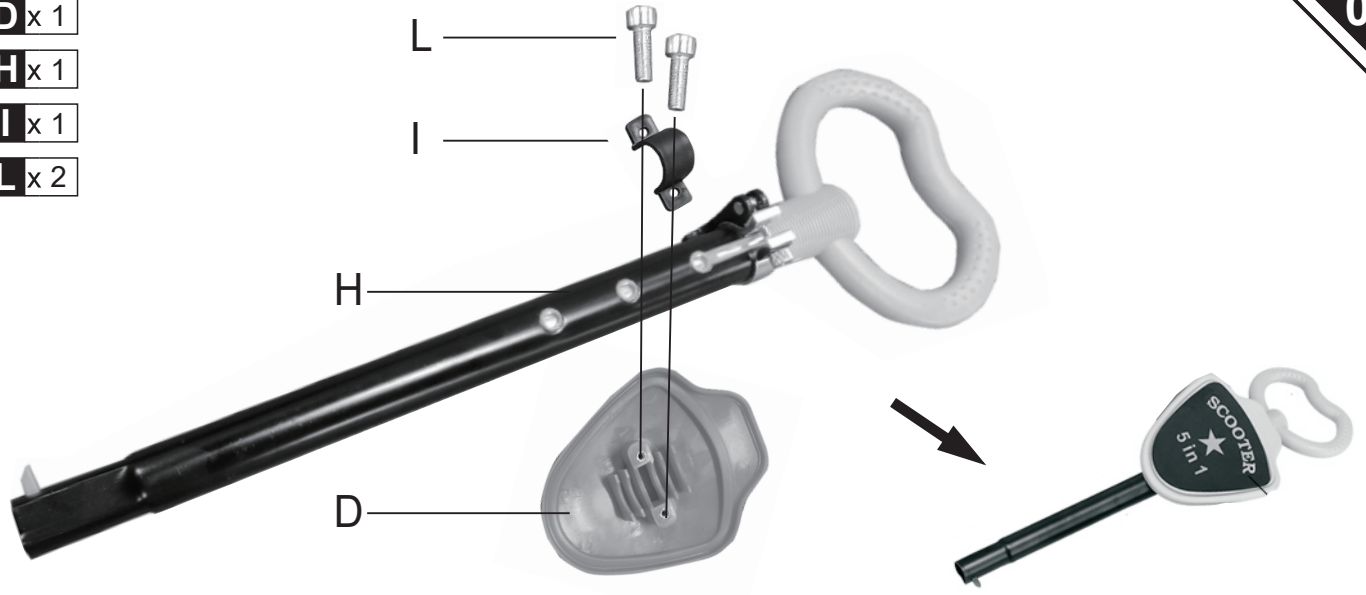

03

A x 1

C x 1

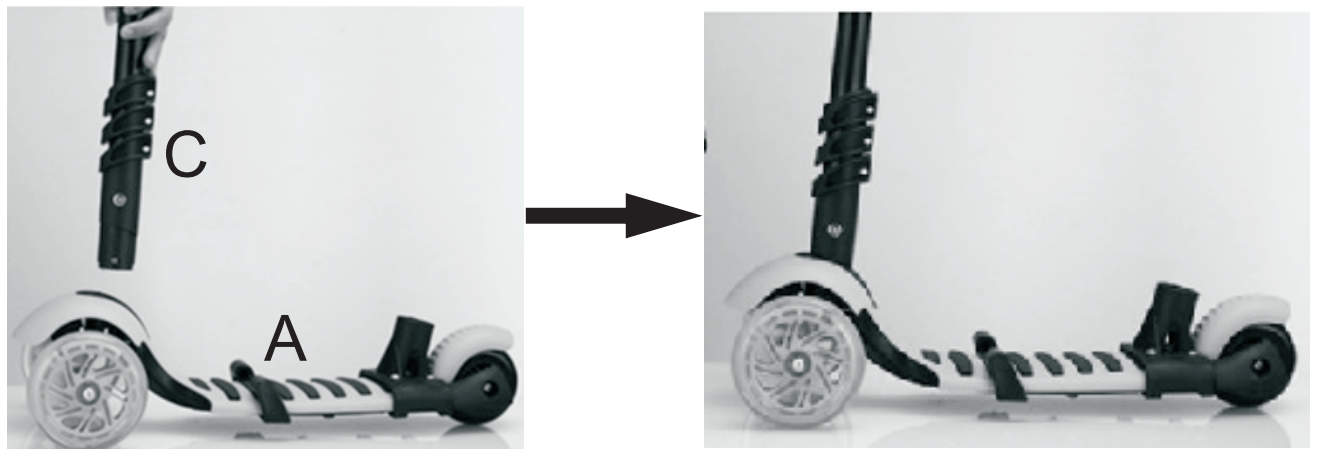

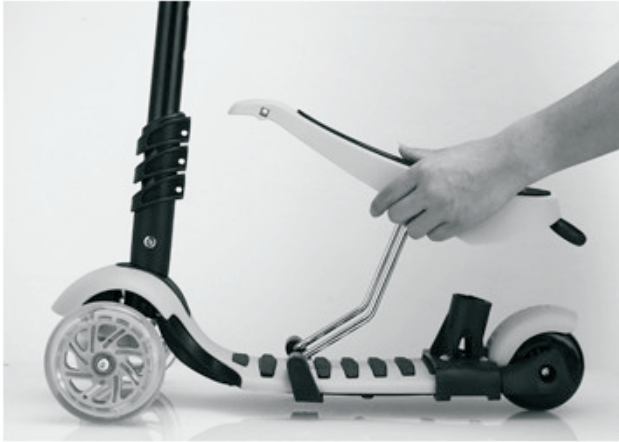

O x 1

P x 1

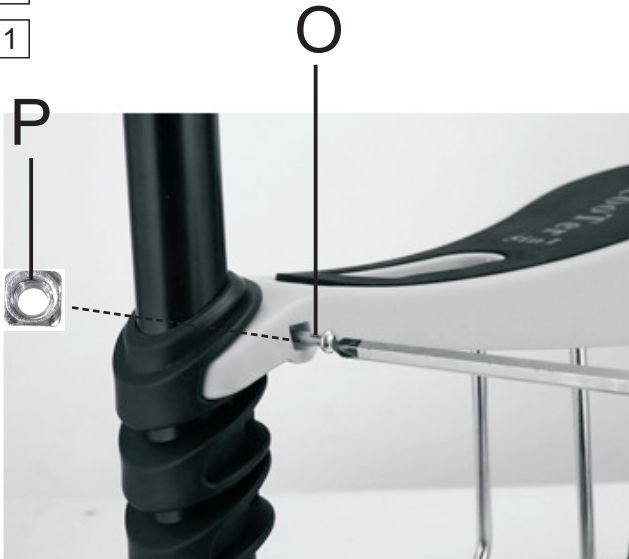

B x 1 **M** x 1

K x 1 **N** x 1

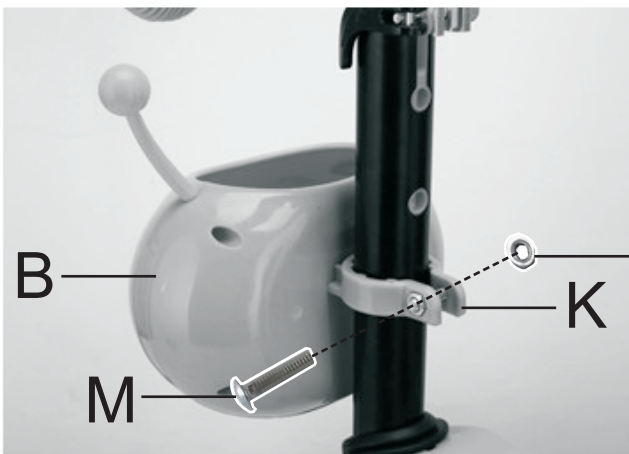

Gracias por la compra de este scooter. Lea atentamente el manual de instrucciones antes de comenzar a usarlo. Este manual contiene importantes informaciones de seguridad e instrucciones completas de uso y mantenimiento. Guarde este manual para futuras consultas. ¡Le deseamos una agradable uso!

REQUERIMIENTOS DE SEGURIDAD

1. Antes de dejar que su hijo viaje en el scooter, asegúrese de que las siguientes piezas estén bien ensambladas: el tubo de la dirección está correctamente montado en un lugar designado, todos los tornillos están firmemente apretados. También verifique la confiabilidad del accesorio de la rueda y asegúrese de que no haya marcas de frotamiento que podrían causar la rotura. Antes de cada uso, el scooter debe revisarse minuciosamente por un adulto.
2. ¡Atención! El usuario debe llevar equipo de protección personal adecuado, como casco de ciclista, palmas protectoras, codos y escudos protectores para la carretera, y botas de goma.
3. No permita que los niños viajen en pendientes pronunciadas. El freno de mano no es adecuado para detenerse a alta velocidad.
4. Los frenos se calientan cuando se detienen. No permita que los niños presionen el freno ni lo accionan durante períodos prolongados. Explique al niño que el contacto con el freno caliente puede causar quemaduras graves en la piel.
5. No permita que los niños circulen a velocidades superiores a 5 km/h por carreteras, caminos de grava y otras zonas de tráfico motorizado.
6. Respete estrictamente las normas de tráfico. Y no circule por la vía pública.
7. Sólo una persona puede viajar en scooter a la vez.
8. No circule en la oscuridad de noche o en condiciones de poca visibilidad.
9. No circule en un scooter en condiciones de humedad.
10. Enséñele a su hijo a andar en un scooter nuevo. Asegúrese de que no se quede en la parte trasera del scooter de forma irresponsable y evite acciones arriesgadas. Haga coincidir la forma de conducción con la experiencia de su hijo.
11. No intente cambiar el diseño del accesorio, de lo contrario se anulará el derecho al servicio de garantía.
12. Peso máximo de un ciclista: 60 kg.
13. ¡Atención! Volver a apretar los tornillos del eje varias veces puede reducir sus propiedades de bloqueo, lo que significa que los tornillos pueden aflojarse. Asegúrese de apretar estos tornillos.

ADVERTENCIAS

1. Antes de montar en scooter, asegúrese de que el volante esté bloqueado de forma segura.
2. Como todos los rodillos, patinetas, bicicletas, etc, este scooter no es absolutamente seguro. Por cierto, no existe equipo deportivo absolutamente seguro. Incluso en perfectas condiciones, también presenta un cierto riesgo de uso.
3. Cuando monta este scooter, utilice siempre un casco de seguridad. Un choque sin casco puede provocar lesiones graves o incluso mortales. ¡Atención! Utilice equipo de protección personal.
4. No corra rápido en clima lluvioso o húmedo con suelo mojado.
5. No monte el scooter durante los días oscuros o en situaciones de poca visibilidad, ya que esta acción puede provocar accidentes graves y lesiones graves.
6. Utilice siempre el equipo de protección personal especificado. Además, se recomienda llevar un chaleco vívido y reflectante.
7. ¡Atención! El freno se calienta mucho durante el frenado.
8. ¡Atención! Hay piezas pequeñas.
9. Peso máximo del niño: hasta 60 kg.
10. Altura máxima permitida: 105 cm

1. Conduzca de manera responsable. Los choques pueden causar lesiones al usuario o a otra persona.
2. Después de un cierto período de tiempo, algunas piezas pueden quedar cubiertas por una capa de óxido. En la mayoría de los casos, esto sucede cuando el usuario circula el scooter por los cuerpos de agua y deja el scooter al aire libre durante mucho tiempo.

MANTENIMIENTO

Compruebe periódicamente el apriete de los tornillos y el estado técnico de las ruedas. Cuando observe que las ruedas están desgastadas, sustitúyalas por unas nuevas. Cuando haya terminado de montarlo, límpielo con un paño húmedo.

PARA GUARDAR EL SCOOTER

1. Retire el pedal y la palanca
2. Inserte el volante en forma de T, y presiónelo firmemente.
3. Primero, alinee el soporte de la base de acuerdo con la posición del asiento.
4. Inserte el soporte del asiento en el soporte del base atornillado. Inserte el asiento frente al zócalo de volante en forma de T y fíjelo de forma segura.
5. Apriete el asiento con el perno
6. Fije el soporte negro insertándolo en la cavidad que se encuentra en la base del scooter.
7. Inserte la manija trasera, y presiónela firmemente.
8. Apriete la hoja de plástico en semicírculo con tornillos.
9. Fije la canasta al volante en forma de T.
10. Finalizado el desmontaje.



Trotinete Infantil 5 em 1

*Adequado para crianças de 1 a 8 anos.

*Peso máximo: 60 kg.



IMPORTANTE, RETER PARA REFERÊNCIA FUTURA: LEIA ATENTAMENTE

MANUAL DE INSTRUÇÕES

Caros clientes,

Obrigado por adquirir este produto. Para que o seu aparelho o sirva melhor, leia todas as instruções deste manual do utilizador. Se tiver alguma dúvida, por favor contacte o nosso Centro de Atendimento ao Cliente.

Os nossos dados de contacto são os seguintes:

País	 Teléfono	 Correo electrónico
PT	0034-931294512	atencioncliente@aosom.es

A x 1



B x 1



C x 1



D x 1



E x 1



F x 1

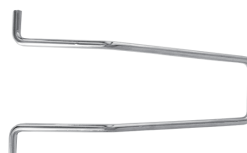

G x 1



H x 1



I x 1



J x 1



K x 1



L x 6



M x 1



N x 1



O x 1



P x 1



Q x 1



01

E x 1

F x 1

G x 1

J x 1

L x 4

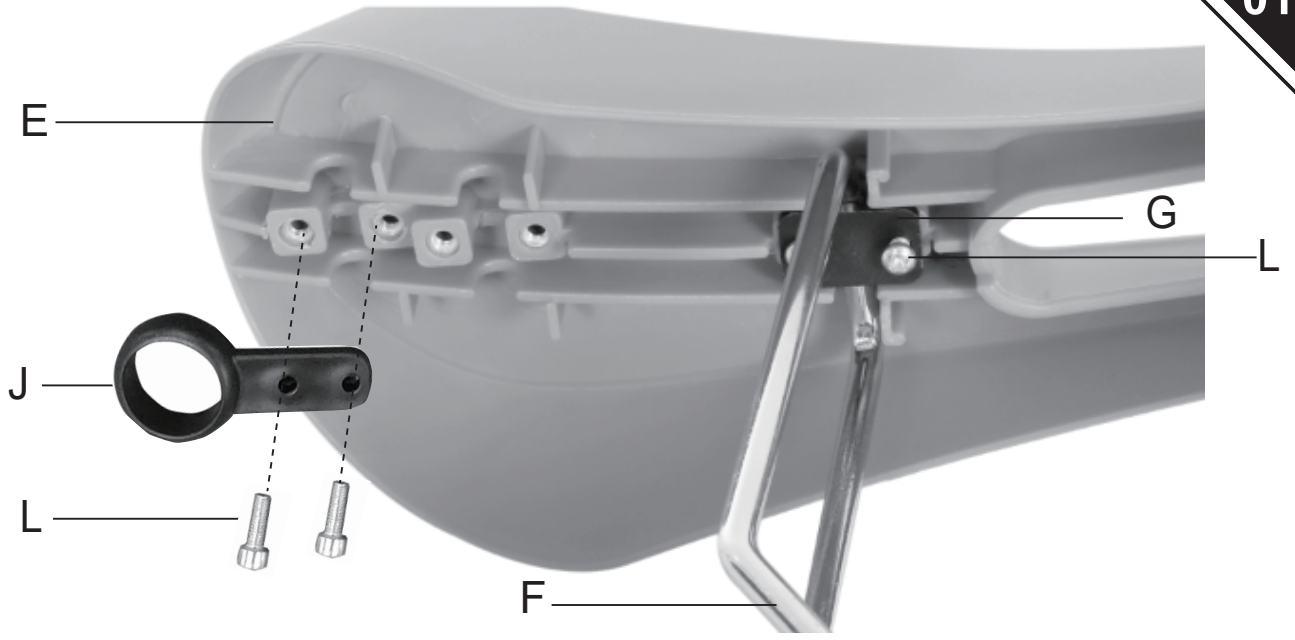

02

D x 1

H x 1

I x 1

L x 2

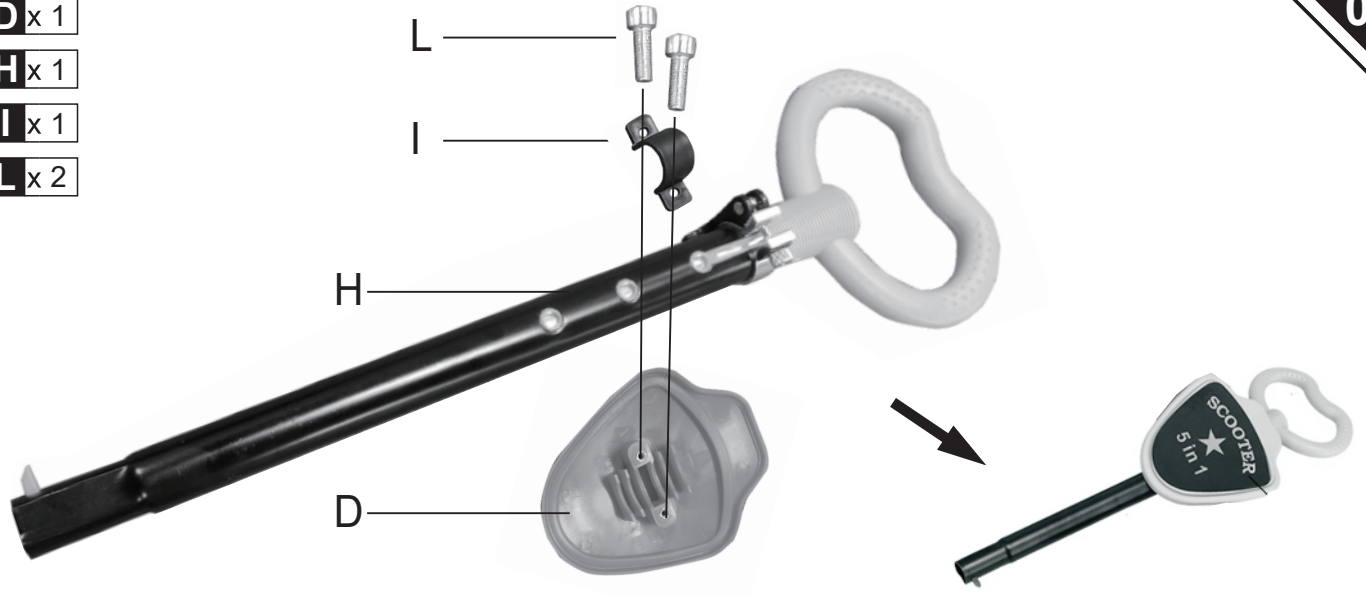

03

A x 1

C x 1

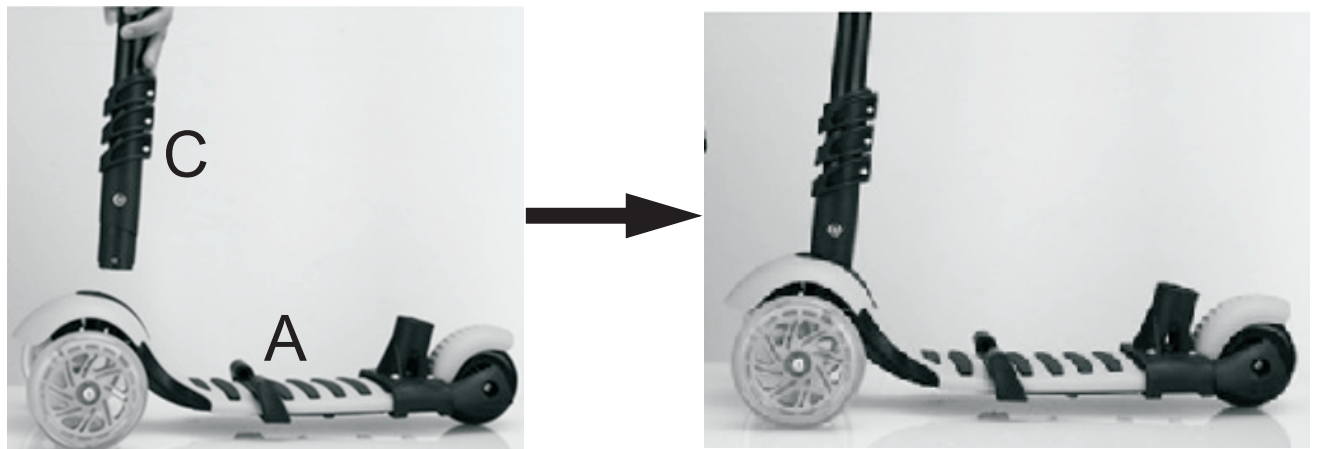



O x 1

P x 1

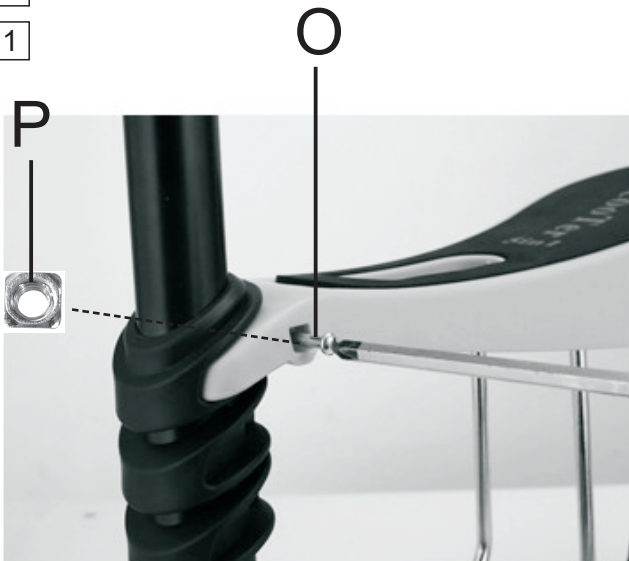

B x 1 **M** x 1

K x 1 **N** x 1

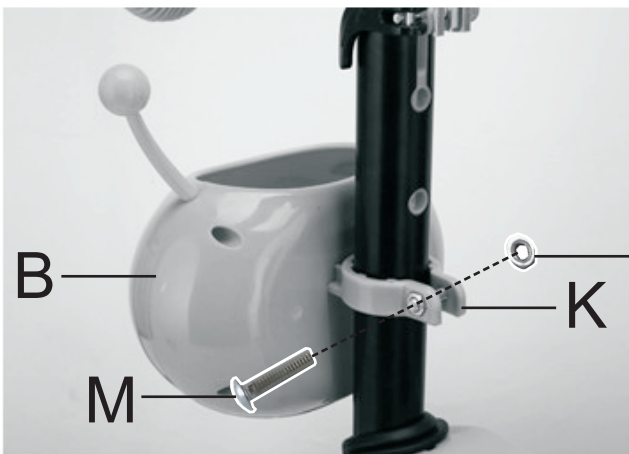

Obrigado por ter adquirido esta trotinete. Por favor, leia atentamente o manual de instruções antes de utilizá-la. Este manual contém importantes informações de segurança e instruções completas de utilização e manutenção. Por favor, guarde este manual para referência futura. Esperamos que seja uma agradável utilização !

REQUISITOS DE SEGURANÇA

1. Antes de deixar o seu filho andar na trotinete, certifique-se de que as seguintes peças estão devidamente montadas: o tubo de direção está correctamente montado num local designado, todos os parafusos são firmemente apertados. Verifique também a configuração do acessório da roda e certifique-se de que não existem marcas de fricção que possam causar roturas. Antes de cada utilização, a trotinete deve ser cuidadosamente verificada por um adulto.
2. Atenção! O utilizador deve usar equipamento de protecção pessoal apropriado, tal como capacete, proteções para os cotovelos e joelhos e botas de borracha.
3. Não permitir que as crianças andem em declives íngremes. O travão de mão não é adequado para parar a alta velocidade.
4. Os travões aquecem quando se pára. Não permitir que as crianças pressionem o travão ou apliquem o travão durante longos períodos de tempo. Explique à criança que o contacto com o travão quente pode causar queimaduras cutâneas graves.
5. Não permitir que as crianças viajem a velocidades superiores a 5 km/h em estradas, estradas de cascalho e outras áreas de tráfego motorizado.
6. Observar rigorosamente as regras de trânsito. E não conduzir em estradas públicas.
7. Apenas uma pessoa pode andar de trotinete de cada vez.
8. Não utilizar no escuro durante a noite ou em condições de má visibilidade.
9. Não andar de trotinete em condições húmidas.
10. Ensine o seu filho a andar na trotinete. Certifique-se de que não andam de forma irresponsável na traseira da trotinete e evite ações arriscadas. Combine o estilo de andar com a experiência do seu filho.
11. Não tente alterar o desenho do acessório, caso contrário, o serviço de garantia será anulado.
12. Peso máximo suportado é de 60 kg.
13. Cuidado! O reaperto dos parafusos de eixo várias vezes pode reduzir as suas propriedades de bloqueio, o que significa que os parafusos podem ficar soltos. Não se esqueça de apertar estes parafusos.

ADVERTÊNCIAS

1. Antes de conduzir a trotinete, certifique-se de que o guiador está bem bloqueado.
2. Como todos os patins, trotinetes, skateboards, bicicletas, etc., esta trotinete não é absolutamente segura. A propósito, não existe equipamento desportivo absolutamente seguro. Mesmo em perfeitas condições, apresenta também um certo risco na utilização.
3. Ao andar nesta trotinete, utilizar sempre um capacete de segurança. Um acidente sem capacete pode resultar em lesões graves ou mesmo fatais. Cuidado! Utilizar sempre equipamento de protecção pessoal, como cotoveleiras e joelheiras.
4. Não andar depressa em tempo chuvoso ou húmido com o solo molhado.
5. Não andar de trotinete durante dias escuros ou em situações de má visibilidade, pois isto pode levar a acidentes graves e ferimentos graves.
6. Usar sempre o equipamento de protecção pessoal especificado. Além disso, recomenda-se o uso de um colete vívido e reflector.
7. Cuidado! O travão torna-se muito quente durante a travagem.
8. Cuidado! Há peças pequenas.
9. Peso máximo da criança: até 60 kg.
10. Altura máxima permitida: 105 cm.

1. Conduzir com responsabilidade. As quedas podem causar lesões ao utilizador ou a outra pessoa.
2. Após um certo período de tempo, algumas partes podem ficar cobertas com uma camada de ferrugem. Na maioria dos casos, isto acontece quando o utilizador conduz a trotinete através de corpos de água e deixa a trotinete ao ar livre durante um longo período de tempo.

MANUTENÇÃO

Verificar o aperto dos parafusos e o estado técnico das rodas a intervalos regulares. Quando notar que as rodas estão gastas, substitua-as por outras novas. Quando a montagem estiver completa, limpe com um pano húmido.

ARMAZENAMENTO DA TROTINETE

1. Retirar o pedal e a alavanca.
2. Inserir o volante em forma de T, e pressioná-lo firmemente para baixo.
3. Primeiro, alinhar o suporte de base de acordo com a posição do assento.
4. Inserir o suporte do assento no suporte de base aparafusado. Inserir o banco em frente da tomada do volante em forma de T e fixá-lo com segurança.
5. Apertar o assento com o parafuso.
6. Fixar o suporte preto, inserindo-o no recesso na base da trotinete.
7. Inserir a pega traseira, e pressioná-la firmemente.
8. Apertar a folha de plástico num semicírculo com parafusos.
9. Fixar o cesto ao cabo T.
10. Processo de desmontagem está completo.



Kinderroller

* Geeignet für Kinder im Alter von 1-8 Jahren.

* Max. Gewicht: 60 kg.



WICHTIG - BITTE HEBEN SIE DIESE ANLEITUNG FÜR
EINE SPÄTERE BEZUGNAHME AUF: SORGFÄLTIG DURCHLESEN

MONTAGEANLEITUNG

Sehr geehrter Kunde,

Vielen Dank, dass Sie dieses Produkt erworben haben. Damit Ihr Gerät Ihnen gute Dienste leistet, lesen Sie bitte alle Hinweise in diesem Benutzerhandbuch. Wenn Sie Fragen haben, wenden Sie sich bitte an unser Kundendienstzentrum.

Unsere Kontaktdaten stehen unten:

Country	 Phone	 Email
DE	0049-0(40)-88307530	service@aosom.de

ADRESSE DES IMPORTEURE:

*MH Handel GmbH
Wendenstraße 309
D-20537 Hamburg
Germany*

IN CHINA HERGESTELLT

A x 1



B x 1



C x 1



D x 1



E x 1



F x 1

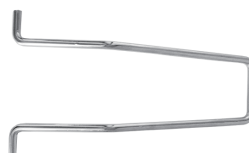

G x 1



H x 1



I x 1



J x 1



K x 1



L x 6



M x 1



N x 1



O x 1



P x 1



Q x 1



01

E x 1

F x 1

G x 1

J x 1

L x 4

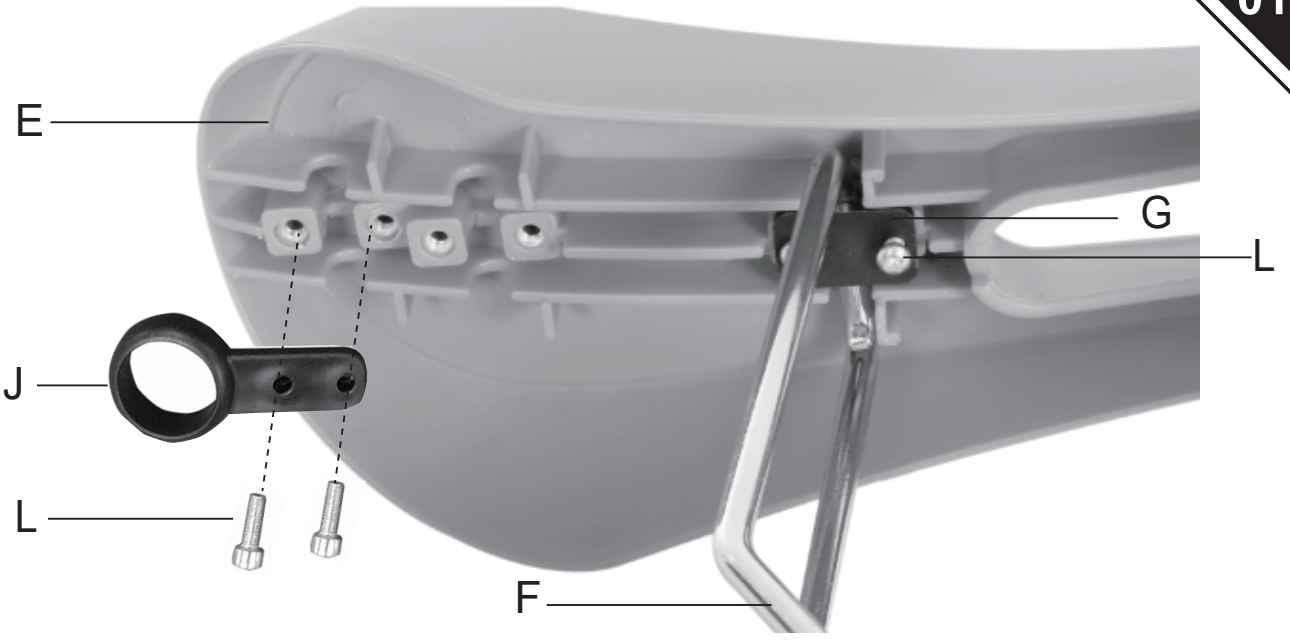

02

D x 1

H x 1

I x 1

L x 2

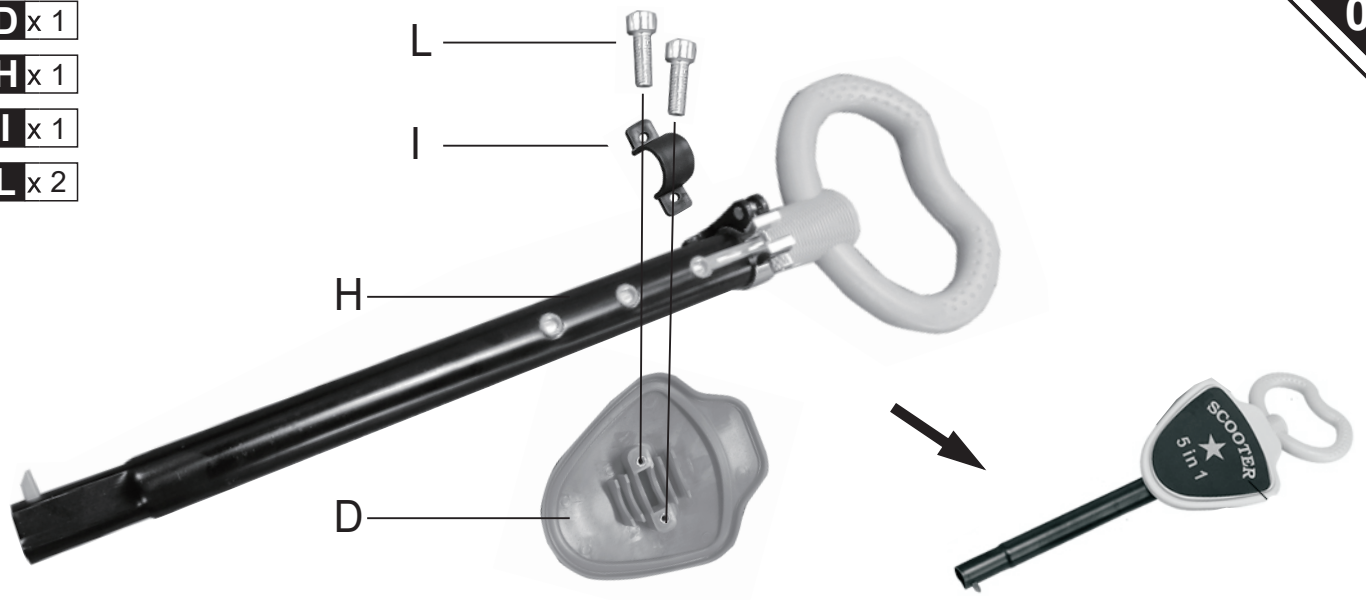

03

A x 1

C x 1

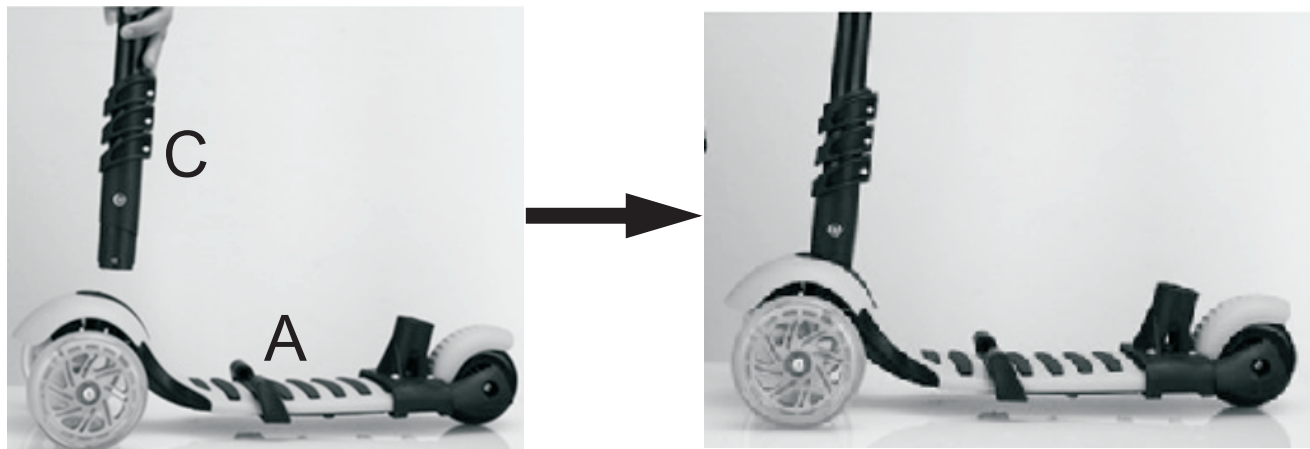



O x 1

P x 1

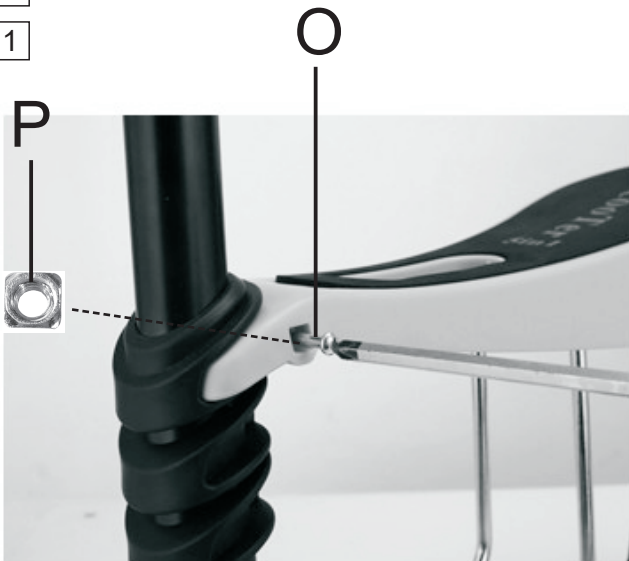

B x 1 **M** x 1

K x 1 **N** x 1

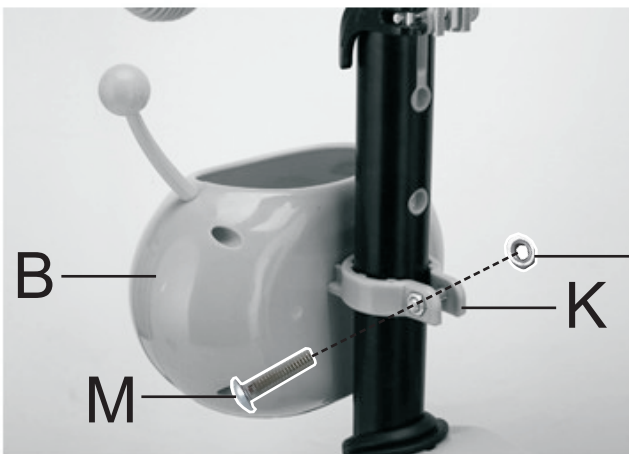

Herzlichen Glückwunsch zum Kauf dieses Rollers. Lesen Sie die Bedienungsanleitung vor dem Start sorgfältig durch reiten. Es enthält wichtige Sicherheitsanforderungen und umfassende Anweisungen für die Nutzung und Wartung. Sichern Sie den Leitfaden für die Zukunft, damit Sie ihn später noch einmal überprüfen können. Wir wünschen Ihnen eine angenehme reiten!

SICHERHEITSANFORDERUNGEN

1. Bevor Sie Ihr Kind fahren lassen, vergewissern Sie sich, dass es sicher montiert ist: Das Lenkrohr ist richtig in einem dafür vorgesehenen Bereich gesichert, werden alle Schrauben fest angezogen. Überprüfen Sie auch die Zuverlässigkeit der Radbefestigung und vergewissern Sie sich, dass keine Scheuerstellen vorhanden sind, die den Bruch verursachen könnten. Vor jeder Fahrt muss der Roller von einem Erwachsenen gründlich überprüft werden.
2. Vorsicht! Ein Fußgänger muss eine angemessene persönliche Schutzausrüstung tragen, z.B. ein Radfahrer Helm, Schutzpalmen, Ellbogen und Straßenschilder und tragen Schuhe mit Gummistiefeln.
3. Erlauben Sie Kindern nicht, an steilen Hängen zu fahren. Die Auffangbremse ist nicht geeignet zum Anhalten an hohe Geschwindigkeit.
4. Die Bremsen werden heiß, wenn die Bremsen angehalten werden. Lassen Sie die Kinder nicht auf die Bremse drücken. über längere Zeiträume oder betätigen Sie die Bremse. Erklären Sie, dass der Kontakt mit der heißen Bremse Folgendes verursachen kann schwere Verbrennungen auf der Haut.
5. Lassen Sie Kinder nicht mit Geschwindigkeiten von mehr als 5 km / h fahren. Straßen, Schotterstraßen und andere motorisierte Verkehrsflächen.
6. Halten Sie sich strikt an die Verkehrsregeln. Gehen Sie nicht auf öffentlichen Straßen spazieren.
7. Nur eine Person darf eines Tages auf einem Roller fahren.
8. Fahren Sie nachts oder bei schlechter Sicht nicht durch die Dunkelheit.
9. Fahren Sie nicht auf einem Roller unter nassen Bedingungen.
10. bringen Sie Ihrem Kind bei, einen neuen Roller zu fahren. Achten Sie darauf, dass es nicht hinter dem Roller zurückbleibt, unverantwortlich und wird riskante Manöver vermeiden. Passen Sie das Fahrmuster an die Erfahrungen Ihres Kindes an.
11. Versuchen Sie nicht, das Anpassungsdesign zu ändern. Auf diese Weise geht das Recht auf Garantieleistungen verloren.
12. Maximales Fahrergewicht: 60 kg.
13. Achtung! Ein mehrmaliges Nachziehen der Achsschrauben verringert deren Sperrwirkung. Das bedeutet, dass sie sich auf ihre eigene Weise entspannen können. Achten Sie darauf, dass diese Schrauben unbedingt nachgezogen werden.

WARNUNGEN

1. Bevor Sie einen Roller fahren, vergewissern Sie sich, dass das Lenkrohr sicher verriegelt ist.
2. Absolut sichere Sportgeräte stehen nicht zur Verfügung. Selbst in einwandfreiem Zustand stellen solche Produkte ein gewisses Gebrauchsrisiko dar.
3. Tragen Sie beim Fahren mit diesem Roller immer einen Sicherheitshelm. Ein Sturz aus einem Helm ohne Helm kann zu schweren oder sogar tödlichen Verletzungen führen. Achtung! Tragen Sie persönliche Schutzausrüstung.
4. Nicht bei Regenwetter oder nassem Wetter benutzen.
5. Fahren Sie an dunklen Tagen oder bei schlechter Sicht nicht herum, da dieses Verhalten zu schweren Stürzen und schweren Verletzungen führen kann.
6. Tragen Sie stets die vorgeschriebene persönliche Schutzausrüstung. Darüber hinaus wird das Tragen einer reflektierenden Schutzweste empfohlen.
7. Achtung! Die Bremse wird beim Bremsen stark erhitzt.
8. Achtung! Es sind Kleinteile vorhanden.
9. Maximales Kindergewicht: bis zu 60 kg.
10. Maximale Körpergröße: 105cm

1. Fahren Sie verantwortungsvoll. Zusammenstöße können die Ursache für Verletzungen eines Fahrers oder einer anderen Person sein.

2. Nach einer gewissen Zeit können einige Teile davon von einer Rostschicht bedeckt sein. In den meisten Fällen geschieht dies, wenn Sie weiterhin um die Gewässer herumfahren und den Roller für lange Zeit im Freien stehen lassen.

WARTUNG

Kontrollieren Sie regelmässig, ob die Schrauben angezogen sind und den technischen Zustand der Räder. Wenn Sie feststellen, dass die Räder abgenutzt sind, ersetzen Sie sie durch neue. Wenn Sie die Fahrt beendet haben, schrubben Sie mit einem feuchten Tuch.

INSTALLATION

1. Entfernen Sie das Pedal und den Hebel

2. T-förmiges Lenkrad einsetzen und fest andrücken.

3. Richten Sie zunächst die Grundhalterung entsprechend der zukünftigen Position des Sitzes aus.

4. Setzen Sie den Sitzbügel in den verschraubten Grundbügel ein. Setzen Sie den Sitz vor das T-förmige Lenkrad ein und befestigen Sie ihn.

5. Ziehen Sie die Sitzschraube mit der Schraube

6. Befestigen Sie den schwarzen Halter, indem Sie ihn in den eingebauten Hohlraum an der Unterseite des Rollers einführen.

7. Setzen Sie den hinteren Griff ein und drücken Sie ihn fest.

8. Ziehen Sie die Plastikfolie halbkreisförmig mit Schrauben fest.

9. Befestigen Sie den Korb am T-förmigen Lenkrad.

10. Installation abgeschlossen.

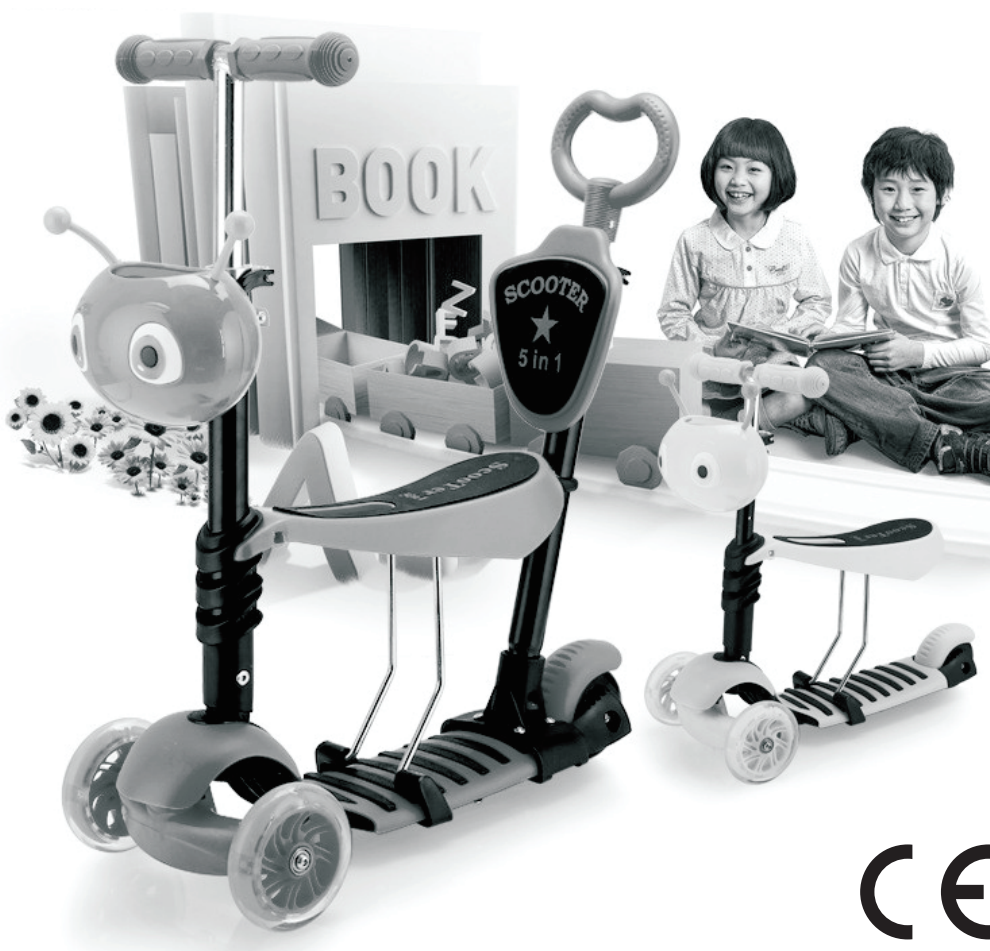

Scooter per bambini 5 IN 1

- * Adatto a bambini di 1-8 anni.
- * Peso massimo: 60 kg.



IMPORTANTE - CONSERVARE QUESTE INFORMAZIONI
PER CONSULTARLE IN SEGUITO: LEGGERE ATTENTAMENTE

ISTRUZIONI DI ASSEMBLAGGIO

Caro Cliente,

Grazie per aver acquistato questo prodotto. Per servirti meglio con questo apparecchio ti prego di leggere tutte le istruzioni in presente manuale utente. In caso di dubbio, si prega di contattare il nostro centro assistenza clienti.

I nostri dettagli di contatto sono di seguito:

Country	 Telefono	 Email
IT	0039-0249471447	clienti@aosom.it

IMPORTATO DA:

*AOSOM Italy srl
Centro Direzionale Milanofiori
Strada 1 Palazzo F1
20057 Assago (MI)
P.I.: 08567220960*

FATTO IN CINA

A x 1



B x 1



C x 1



D x 1



E x 1



F x 1

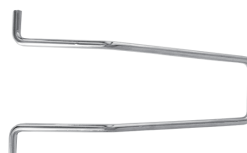

G x 1



H x 1



I x 1



J x 1



K x 1



L x 6



M x 1



N x 1



O x 1



P x 1



Q x 1



01

E x 1

F x 1

G x 1

J x 1

L x 4

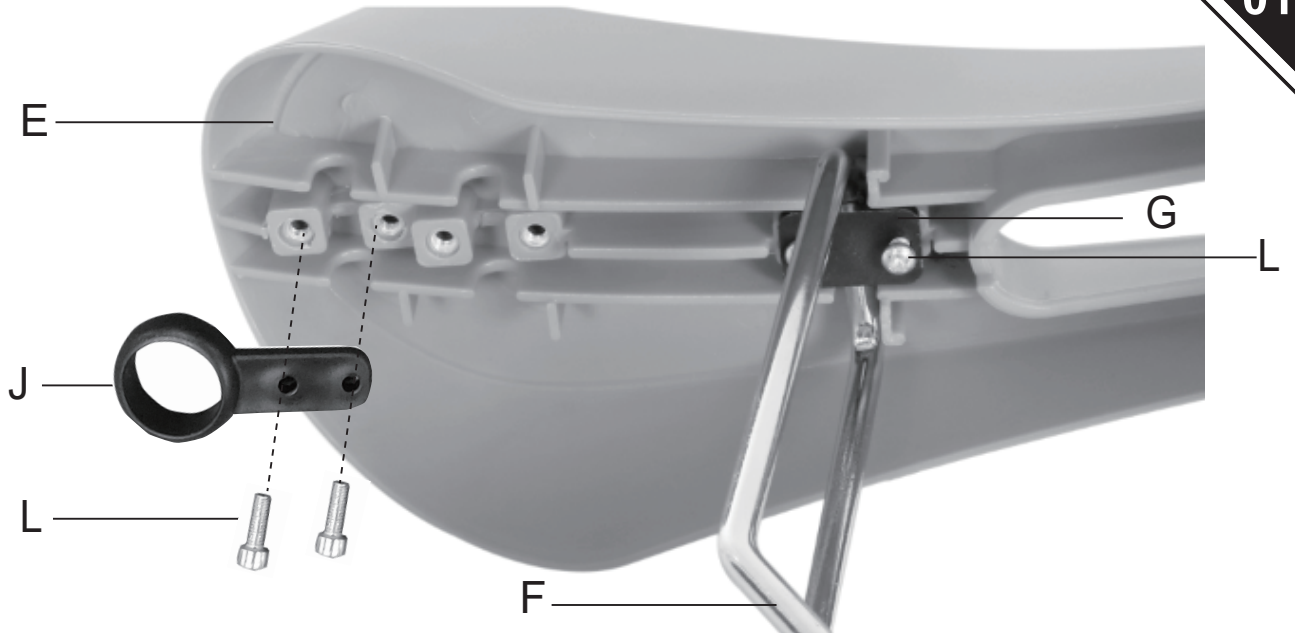

02

D x 1

H x 1

I x 1

L x 2

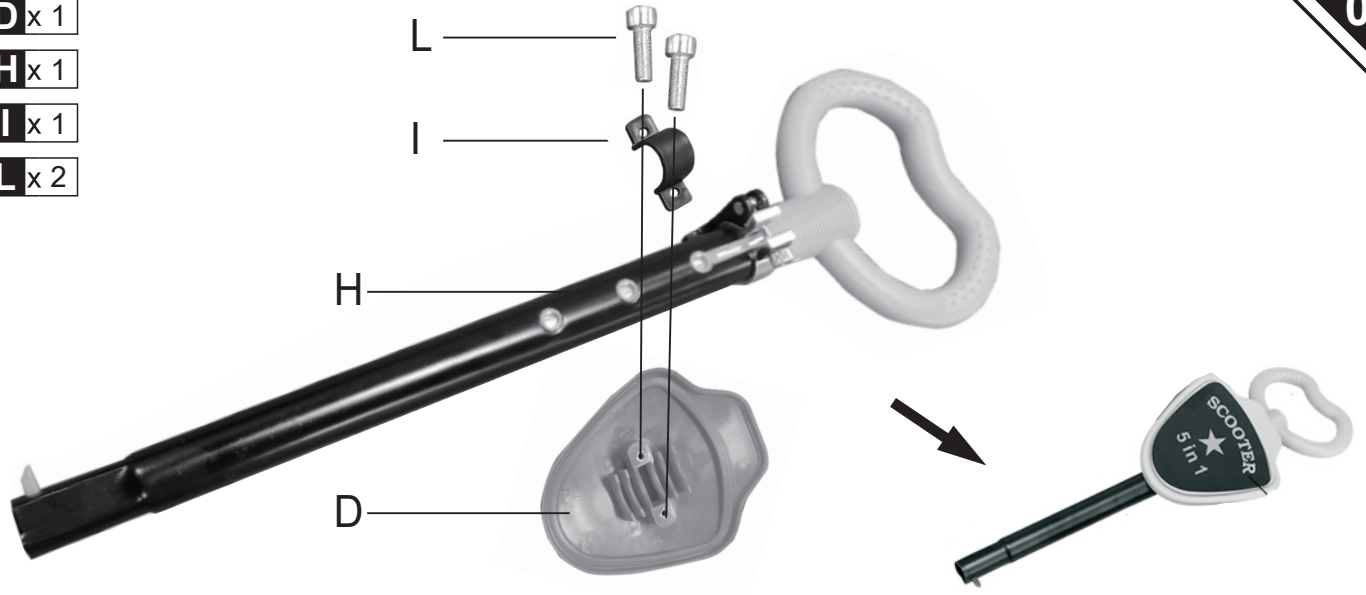

03

A x 1

C x 1

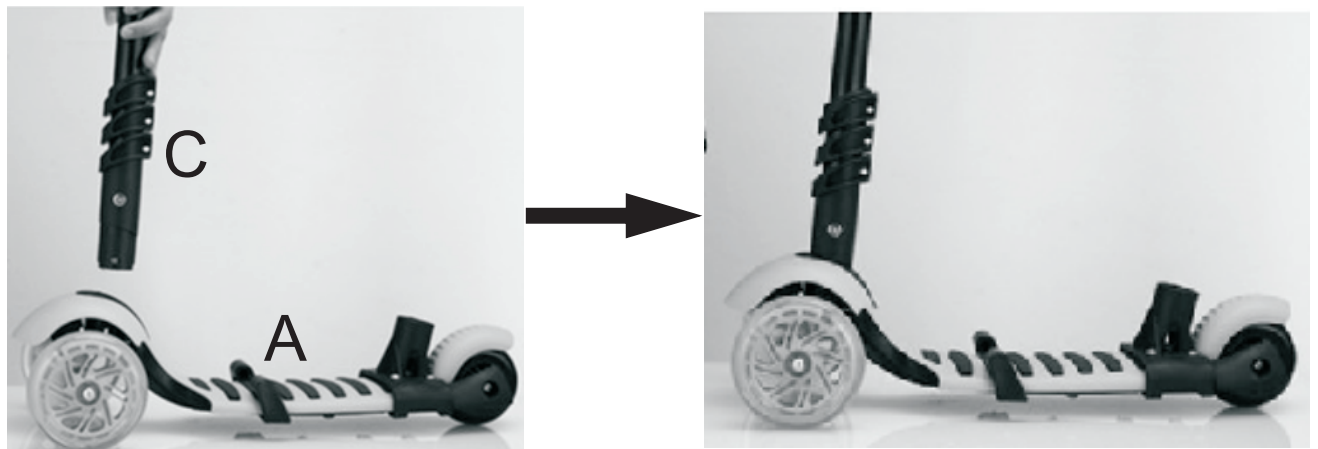



O x 1

P x 1

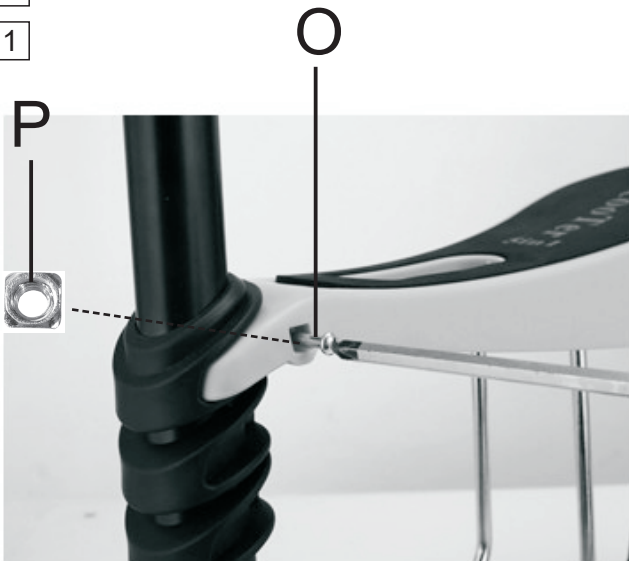

B x 1 **M** x 1

K x 1 **N** x 1

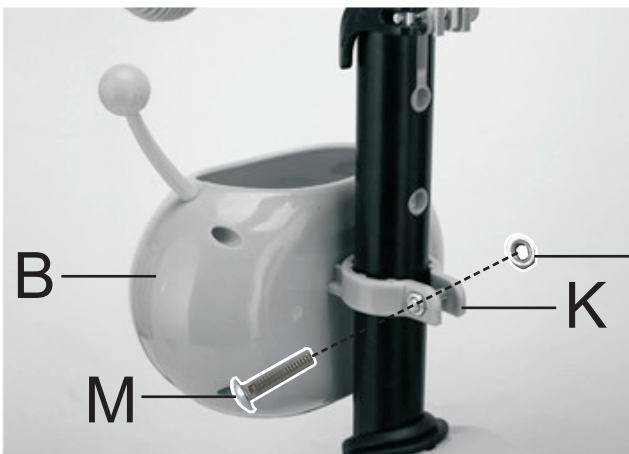

Congratulazioni aver acquistato questo scooter. Leggere attentamente il manuale di istruzioni prima di iniziare. Esso contiene importanti precauzioni di sicurezza e istruzioni complete per l'uso e la manutenzione. Conservare il manuale per potervi fare riferimento in futuro. Vi auguriamo un piacevole giro in scooter!

PRECAUZIONI DI SICUREZZA

1. Prima di far guidare il bambino, assicurarsi che il prodotto sia saldamente assemblato: il tubo dello sterzo è correttamente fissato nell'area designata, tutte le viti sono strette saldamente. Controllare anche l'affidabilità della ruota e assicurarsi che non ci siano segni di attrito che potrebbero causare la rottura. Prima di ogni viaggio, lo scooter deve essere accuratamente controllato da un adulto.
2. Attenzione! L'utente deve indossare dispositivi di protezione individuale adeguati come un casco da ciclista, guanti protettivi, protezioni dei gomiti e indossare scarpe con soles di gomma.
3. Non consentire ai bambini di guidare su pendii ripidi. Il freno di ripresa non è adatto per l'arresto alte velocità.
4. I freni si surriscaldano quando vengono attivati. Non lasciare che i bambini premano il freno o lo azionino a lungo. Spiegare loro che il contatto con il freno caldo può causare gravi ustioni alla pelle.
5. Non lasciare che i bambini viaggino a velocità superiori a 5 km / h. su strade, strade sterrate e altre zone con traffico motorizzato.
6. Rispettare rigorosamente le regole del traffico. Non uscire per una guida su strade pubbliche.
7. Solo una persona alla volta può salire sullo scooter.
8. Non guidare al buio di notte o in condizioni di scarsa visibilità.
9. Non correre su uno scooter in condizioni di bagnato.
10. Insegna a tuo figlio a guidare un nuovo scooter. Assicurati che non rimanga in ritardo rispetto allo scooter, irresponsabilmente ed eviterà manovre rischiose. Abbina lo schema di guida all'esperienza di tuo figlio.
11. Non tentare di modificare il design dello scooter. In questo modo si perde il diritto al servizio di garanzia.
12. Peso massimo per utente: 60 kg.
13. Attenzione! Stringere ripetutamente le viti dell'asse riduce le loro proprietà di bloccaggio. Questo significa che possono allentarsi naturalmente. Assicurati di stringere questi bulloni.

AVVERTENZE

1. Prima di guidare uno scooter, assicurarsi che il volante sia ben saldo.
2. Questo scooter, come tra gli altri tutti i pattini, skateboard, biciclette e così via, non è un'attrezzatura assolutamente sicura. Anche in perfette condizioni, tale attrezzatura presenta un certo rischio durante l'utilizzo.
3. Quando si guida questo scooter, indossare sempre un casco antinfortunistico. Uno schianto senza casco può causare lesioni gravi o addirittura mortali. Attenzione! Indossare dispositivi di protezione individuale.
4. Non procedere ad alta velocità in caso di pioggia o bagnato con tempo umido.
5. Non andare in giro durante i giorni bui o in situazioni di scarsa visibilità, poiché questo comportamento può causare incidenti gravi e lesioni gravi.
6. Indossare sempre i dispositivi di protezione individuale specificati. Inoltre, si consiglia di indossare un gilet dal colore vivido e rifrangente.
7. Attenzione! Il freno si scalda molto durante la frenata.

8. Attenzione! Presenza di piccole parti.
9. Peso massimo del bambino: fino a 60 kg.
10. Tuta per l'altezza massima del corpo: 105 cm

1. Guidare in maniera responsabile. La velocità e le collisioni possono essere la causa di lesioni all'utente o ad altre persone.
2. Dopo un lungo periodo di utilizzo, alcune parti potrebbero essere ricoperte da uno strato di ruggine. Nella maggior parte dei casi, ciò accade quando si continua a guidare in presenza di fonti d'acqua o si lascia lo scooter a lungo all'aperto.

MANUTENZIONE

Controllare regolarmente che i bulloni siano ben stretti e lo stato delle ruote. Quando si nota che le ruote sono usurate, sostituirle con delle nuove. Quando avete finito di pedalare, strofinare con un panno umido.

CONSERVAZIONE

1. Ritrarre il pedale e la leva.
2. Spingere lo sterzo a T, premere con decisione.
3. Per prima cosa, allineare la staffa di base secondo la posizione desiderata del sedile.
4. Inserire la staffa del sedile nella staffa della base già avvitata. Inserire il sedile davanti alla presa dello sterzo a T e fissarlo in posizione.
5. Stringere il bullone del sedile con quello della staffa.
6. Fissare il supporto nero inserendolo nell'incavo prevista alla base dello scooter.
7. Spingere la maniglia posteriore, premere con decisione.
8. Fissare la pellicola in plastica a semicerchio con le viti.
9. Fissare il cestello allo sterzo a T.
10. Prodotto ripiegato completamente.