



IN221200234V01\_UK

**342-007\_342-007V01**



**UK  
CA  
CE**

# **INSTRUCTION MANUAL**

**(HEXAGON WITH SAFETY NET)**



IMPORTANT, RETAIN FOR FUTURE REFERENCE: READ CAREFULLY

**ASSEMBLY INSTRUCTION**

**Dear customer,**

Thank you for purchasing this product. So that your appliance serves you well, please read all the instructions in this user's manual. If you have any questions, please contact our customer care center.

**Our contact details are below:**

Country	 Phone	 Email
UK	0044-800-240-4004	enquiries@mhstar.co.uk

**IMPORTER ADDRESS:**

MH STAR UK LTD  
Unit 27, Perivale Park,  
Horsenden lane South  
Perivale, UB6 7RH

MADE IN CHINA

**WARNING**

Always install the trampoline with **at least two people**. keep head and face away from frame of trampoline. Failure to do so can cause serious injury to head or face, or lead to other serious injuries. We are not liable for any injuries that may occur when using the trampoline.

Table of contents

Parts list .....3









Notes & Warnings .....4

Assembly Instructions .....4, 5

Assembly Instruction for stabilizing bar.....5, 6

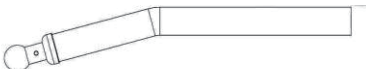
## Parts list

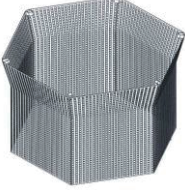
Ref.Number	Part Number	Description	Unit
1	TR01	Trampoline frame	6
2	TR02	Trampoline legs	6
3	TR03	Jump mat	1
4	TR04	Elastic springs	36
5	TR05	Net pole top	6
6	TR06	Net pole bottom	6
7	TR07	Net	1
8	TR08	Screws	24
9	TR09	Tool 1	1
10	TR15	Manual	1

 <p>TR01 x 6pcs</p>	 <p>TR02 x 6pcs</p>	 <p>TR03 x 1pcs</p>
 <p>TR04 x 36pcs</p>	 <p>TR05 x 6 pcs</p>	 <p>TR06 x 6pcs</p>
 <p>TR07 x 1pcs</p>	 <p>TR08 x 24pcs</p>	 <p>TR09x 1pcs</p>

## Notes & Warnings

1. This product should not be used by persons weighting more than 60kgs.
2. The legs of the trampoline are installed tightly , please make sure not to pinch your fingers or hand during assembly.
3. The elastic springs can be stiff in the early stages of usage of the trampoline and will loosen with time. Please be careful while install the trampoline and do not hurt your body .
4. Must use elevated trampoline on wall to wall carpet or a floor than is not slippery so unit does not slide when used.

## Assembly Instructions

1. Lay all the trampoline part on the floor, connect 6 piece trampoline frame.

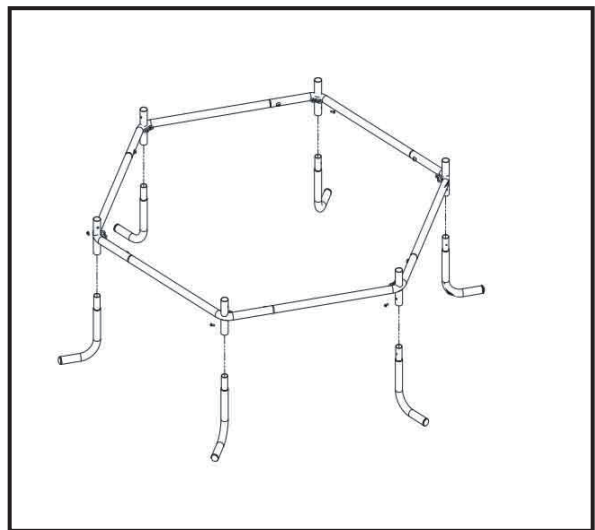
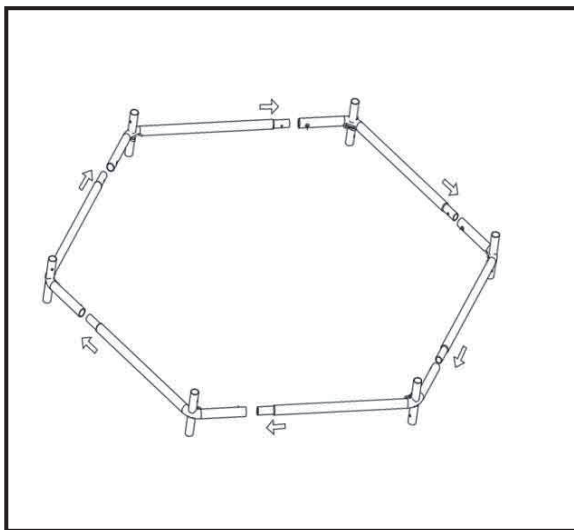

2. Install the “L” leg tube into the main rack in turn and tighten the screws by tool.
3. With the trampoline frame now open and take out the jump mat in the middle of the frame ,now start to install the elastic springs, Install two

elastic spring by two side of the frame ,Install the elastic spring to other two side of the frame, keep on install other ropes as show. (attention: Install the jump mat need base on below Assembly Instructions)

Note: Please wear gloves when You install the elastic springs.

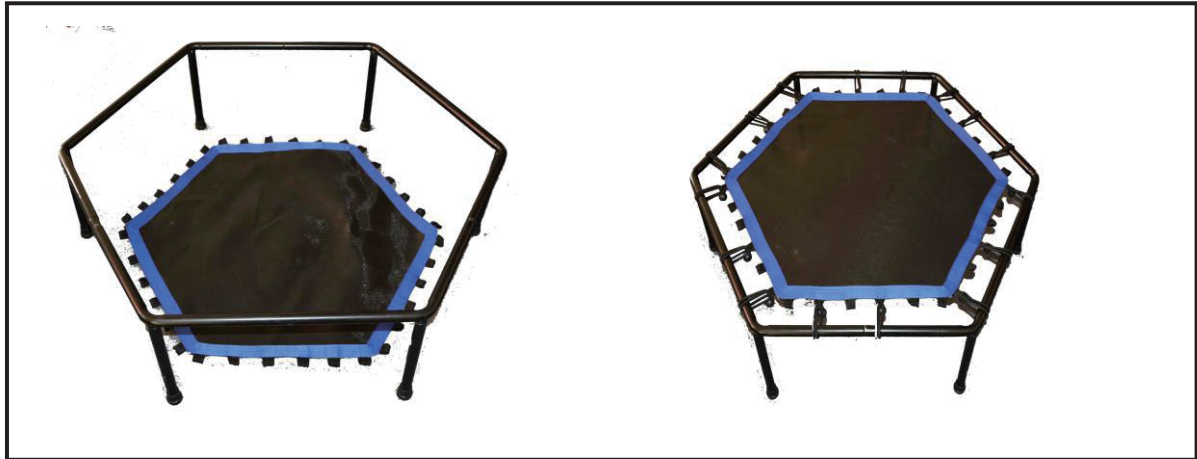

4. Insert the top net pole and bottom net pole into the main frame separately as show .

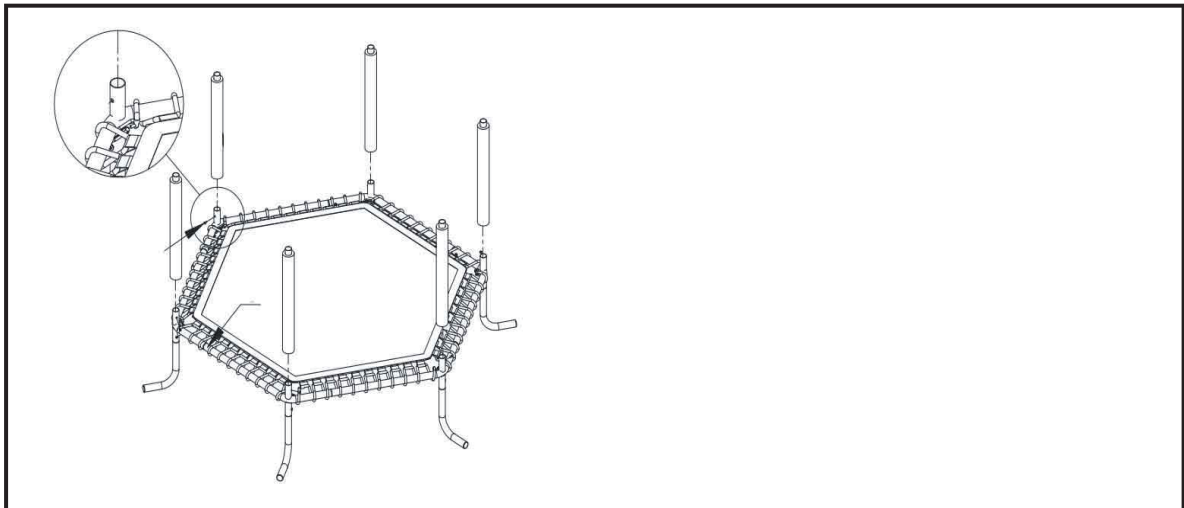

5. Secure the net from the top down to the main rack with the fastening buckle of the net on the ball head and tie the elastic band below to the pipe below.

