

EN_IMPORTANT, RETAIN FOR FUTURE REFERENCE: READ CAREFULLY.

FR_IMPORTANT: A LIRE ATTENTIVEMENT ET À CONSERVER POUR CONSULTATION ULTÉRIEURE.

ES_IMPORTANTE, LEA Y GUARDE PARA FUTURAS REFERENCIAS.

PT_IMPORTANTE, RETER PARA REFERÊNCIA FUTURA: LEIA ATENTAMENTE.

DE_WICHTIG! SORGFÄLTIG LESEN UND FÜR SPÄTER NACHSCHLAGEN AUFBEWAHREN.

IT_IMPORTANTE! CONSERVARE IL PRESENTE MANUALE PER FUTURO RIFERIMENTO E LEGGERLO ATTENTAMENTE.

EN**Dear customer,**

Thank you for purchasing this product. So that your appliance serves you well, please read all the instructions in this user's manual. If you have any questions, please contact our customer care center, Our contact details are below:

FR**Cher client,**

Nous vous remercions d'avoir acheté ce produit. Afin que vous puissiez profiter pleinement de votre appareil, veuillez lire toutes les instructions de ce manuel d'utilisation. Si vous avez la moindre question, veuillez contacter notre centre d'assistance à la clientèle, Nos coordonnées sont les suivantes:

DE**Sehr geehrter Kunde,**

Vielen Dank, dass Sie dieses Produkt erworben haben. Damit Ihr Gerät Ihnen gute Dienste leistet, lesen Sie bitte alle Hinweise in diesem Benutzerhandbuch. Wenn Sie Fragen haben, wenden Sie sich bitte an unser Kundendienstzentrum, Unsere Kontaktdaten stehen unten:

ES**Queridos clientes,**



Gracias por comprar este producto. Para que su electrodoméstico le sirva mejor, lea todas las instrucciones de este manual del usuario. Si tiene alguna pregunta, comuníquese con nuestro Centro de Atención al Cliente, Nuestros datos de contacto son los siguientes:

PT**Caros clientes,**

Obrigado por adquirir este produto. Para que o seu aparelho o sirva melhor, leia todas as instruções deste manual do utilizador. Se tiver alguma dúvida, por favor contacte o nosso Centro de Atendimento ao Cliente, Os nossos dados de contacto são os seguintes:

IT**Caro Cliente,**

Grazie per aver acquistato questo prodotto. Per servirti meglio con questo apparecchio ti prego di leggere tutte le istruzioni in presente manuale utente. In caso di dubbio, si prega di contattare il nostro centro assistenza clienti, I nostri dettagli di contatto sono di seguito:

Country	 Phone	 Email
US	001-877-644-9366	customerservice@aosom.com
CA	416-792-6088	customerservice@aosom.ca
UK	0044-800-240-4004	enquiries@mhstar.co.uk
DE	0049-0(40)-88307530	service@aosom.de
FR	0033-1-84166106	aosom@mhfrance.fr
ES	0034-931294512	atencioncliente@aosom.es
PT	0034-931294512	info@aosom.pt
IT	0039-0249471447	clienti@aosom.it

WARNING:

1. Two adults are recommended for ease of assembly. Be careful when assembly, please wear gloves.
2. Assembly recommended on a soft surface, such as carpet, to avoid scratching flooring finish.
3. Do not allow children to climb or play in or around the clothes shelves.
4. Keep bags and plastic sheeting away from babies and children. Do not use in cribs, beds, carriages, or playpens. The plastic may cling to nose and mouth and prevent breathing.

ATTENTION:

1. Don't play on the clothes shelves.
2. Please don't touch the transect of the tube, it is quite sharp
3. Must put the tube into the bottom of plastic accessories.
4. Must tighten the screw and the nut.
5. Please make sure to place the hanger at level position and keep balance when hanging clothes.
6. Please keep away from stove and fire.

CARE INSTRUCTIONS:

When cleaning your furniture, use a non-toxic and non-abrasive cleaner. Apply to the surface with a soft, dry cloth, dampened in the solution. After cleaning, dry completely with a soft dry cloth.

AVERTISSEMENT:

1. Deux adultes sont nécessaires pour faciliter le montage. Soyez prudent lors du montage, veuillez porter des gants.
2. Montage recommandé sur une surface souple, comme un tapis, pour éviter de rayer la finition du sol.
3. Ne laissez pas les enfants grimper ou jouer dans ou autour des étagères à vêtements.
4. Gardez les sacs et les bâches en plastique hors de portée des bébés et des enfants. Ne les utilisez pas dans les berceaux, les lits, les poussettes ou les parcs pour enfants. Le plastique peut se coller au nez et à la bouche et empêcher de respirer.

ATTENTION:

1. Ne jouez pas sur les étagères à vêtements.
2. Ne touchez pas la section du tube, elle est très coupante.
3. Le tube doit être placé dans le fond des accessoires en plastique.
4. Serrer les vis et les écrous.
5. Veillez à placer le cintre en position horizontale et à garder l'équilibre lorsque vous suspendez vos vêtements.
6. Tenir à l'écart du four et du feu.

INSTRUCTIONS D'ENTRETIEN:

Lorsque vous nettoyez vos meubles, utilisez un produit de nettoyage non toxique et non abrasif. Appliquez sur la surface avec un chiffon doux et sec, humidifié dans la solution. Après le nettoyage, séchez complètement avec un chiffon doux et sec.

ADVERTENCIA:

1. Se requieren 2 adultos para realizar el montaje. Tenga mucho cuidado durante el montaje, use guantes.
2. Con el fin de evitar rayar el acabado del piso, se recomienda realizar el montaje sobre una superficie blanda, por ejemplo una alfombra.
3. No permita que los niños se trepen o jueguen dentro o alrededor de los estantes de ropa.
4. Mantenga las bolsas y las láminas de plástico fuera del alcance de los niños y bebés. No lo utilice en cunas, camas, carritos o parques, existen riesgos de asfixia e impiden la respiración.

ATENCIÓN:

1. No juegue cerca los estantes de ropa.
2. No toque el transecto del tubo, es muy afilado.
3. Debe colocar el tubo en la parte inferior de los accesorios de plástico.
4. Apriete el tornillo y la tuerca firmemente.
5. Asegúrese de colocar la percha en una posición nivelada, mantenga el equilibrio al colgar la ropa.
6. Mantenga el mueble alejado de la estufa y el fuego.

INSTRUCCIONES DE CUIDADO:

Para limpiar los muebles, utilice un limpiador no tóxico y no abrasivo. Limpie la superficie de mueble con un paño suave y seco humedecido en la solución. Después de la limpieza, séquelo con un paño suave y seco completamente.

ATENÇÃO:

1. Dois adultos são recomendados para facilitar a montagem. Tenha cuidado na montagem, por favor use luvas.
2. Recomenda-se a montagem numa superfície macia, como o tapete, para evitar arranhar o piso.
3. Não permitir que as crianças subam ou brinquem dentro ou à volta do charriot de roupas.
4. Mantenha os sacos e os plásticos afastados de bebés e crianças. O plástico pode grudar no nariz e na boca e impedir a respiração.

ATENÇÃO:

1. Não brincar nas prateleiras das roupas.
2. Por favor, não toque no transecto do tubo, é bastante afiado
3. Deve colocar o tubo no fundo dos acessórios de plástico.
4. Tem de apertar o parafuso e a porca.
5. Por favor, certifique-se de colocar o cabide na posição nivelada e manter o equilíbrio quando pendurar a roupa.
6. Por favor, mantenha-se afastado de locais inflamáveis.

INSTRUÇÕES DE CUIDADO:

Ao limpar os seus móveis, utilize um produto de limpeza não tóxico e não abrasivo. Aplique na superfície com um pano macio e seco, humedecido na solução. Após a limpeza, secar completamente com um pano macio e seco.

WARNUNG:

1. Es werden zwei Erwachsene empfohlen, um die Montage zu erleichtern. Seien Sie bei der Montage vorsichtig, tragen Sie bitte Handschuhe.
2. Die Montage wird auf einer weichen Oberfläche, z. B. einem Teppich, empfohlen, um Kratzer auf dem Bodenbelag zu vermeiden.
3. Erlauben Sie Kindern nicht, in oder um die Kleiderregale herum zu klettern oder zu spielen.
4. Halten Sie Beutel und Plastikfolien von Babys und Kindern fern. Nicht in Kinderbetten, Betten, Kinderwagen oder Laufställen verwenden. Der Kunststoff kann sich an Nase und Mund festsetzen und die Atmung behindern.

ACHTUNG:

1. Nicht auf den Kleiderregalen spielen.
2. Bitte berühren Sie den Querschnitt der Röhre nicht, es ist ziemlich scharf
3. Führen Sie das Rohr in den Boden des Kunststoffzubehörs ein.
4. Ziehen Sie die Schraube und die Mutter an.
5. Achten Sie darauf, dass Sie den Kleiderbügel waagrecht anbringen und das Gleichgewicht halten, wenn Sie Kleidung aufhängen.
6. Bitte von Herd und Feuer fernhalten.

PFLEGEHINWEISE:

Verwenden Sie zur Reinigung Ihrer Möbel einen ungiftigen und nicht scheuernden Reiniger. Tragen Sie die Lösung mit einem weichen, trockenen, mit der Lösung benetztem Tuch auf die Oberfläche auf. Trocknen Sie das Gerät nach der Reinigung vollständig mit einem weichen, trockenen Tuch ab.

AVVERTENZA:

1. E' consigliabile di lavorare con due adulti per facilitare il montaggio. Fare attenzione durante il montaggio, indossare dei guanti.
2. Montaggio consigliato su una superficie morbida, come un tappeto, per evitare di graffiare la finitura del pavimento.
3. Non permettere ai bambini di arrampicarsi o giocare dentro o intorno alle scaffalature dei vestiti.
4. Tenere borse e teli di plastica lontano dalla portata di neonati e bambini. Non utilizzarli in culla, letti, carrozze o box. La plastica può aderire al naso e alla bocca e impedire la respirazione.









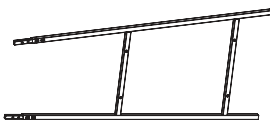
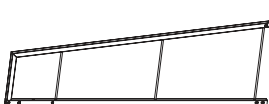

ATTENZIONE:

1. Non giocare sulle scaffalature dei vestiti.
2. Si prega di non toccare il transetto del tubo, in quando è tagliente.
3. Posizionare il tubo nella parte inferiore degli accessori in plastica.
4. Stringere la vite e il dado.
5. Assicurarsi di posizionare il gancio in posizione orizzontale e di mantenere l'equilibrio quando si appendono i vestiti.
6. Si prega di tenere lontano da fornelli e dal fuoco.

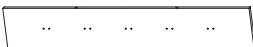



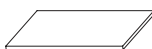
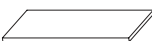
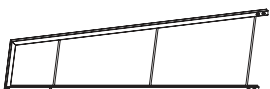
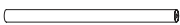





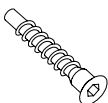

ISTRUZIONI PER LA CURA:

Quando pulite i vostri mobili, usate un detergente non tossico e non abrasivo. Applicare sulla superficie con un panno morbido e asciutto, inumidito nella soluzione detergente. Dopo la pulizia, asciugare completamente con un panno morbido e asciutto.

PARTS

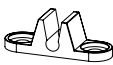
	1 x3		8 x1
	2 x6		9 x1
	3 x1		10 x1
	4 x1		11 x1
	5 x1		12 x1
	6 x1		13 x1
	7 x1		14 x1
			15 x2

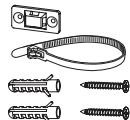
HARDWARE

A x6 	B x28 +1 (spare) 	C x4 	D x5 	E x10 +1 (spare) 	F x13 +1 (spare)  M6x10	G x4  M6x12
H x 1 	I x12 	J x24 +1 (spare) 	K x 1 	L x 2 	M x1 	

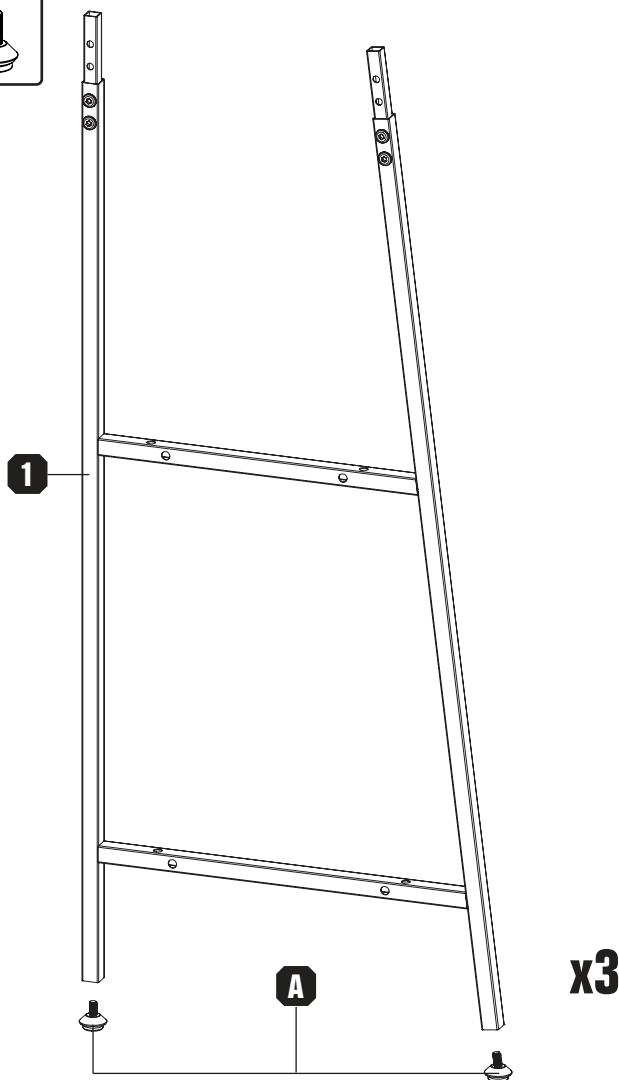
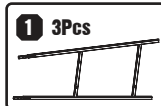

- EN_** Do not confuse similar screws. Do not tighten bolts fully until all parts are connected!
- FR_** Ne pas confondre des vis similaires. Ne serrez pas les boulons à fond tant que toutes les pièces ne sont pas connectées!
- ES_** No confunda tornillos similares. No apriete los tornillos completamente hasta que todas las partes están conectadas!
- PT_** Não confundir parafusos semelhantes. Não apertar completamente os parafusos até que todas as peças estejam encaixadas!
- DE_** Verwechseln Sie ähnliche Schrauben nicht. Ziehen Sie die Schrauben erst fest an, wenn alle Teile verbunden sind!
- IT_** Non confondere le viti simili. non serrare completamente i bulloni fino a tutte le parti non sono ancora collegate!

02

2 4Pcs

B 8Pcs

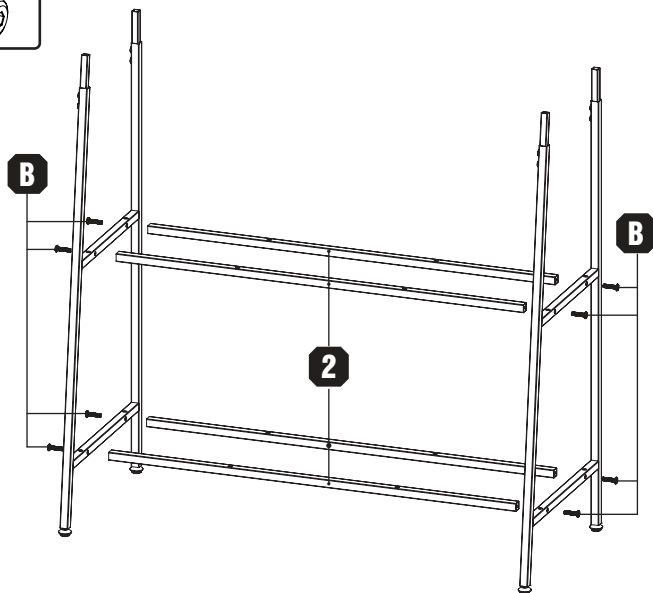

03

3 1Pc

4 1Pc



B 8Pcs

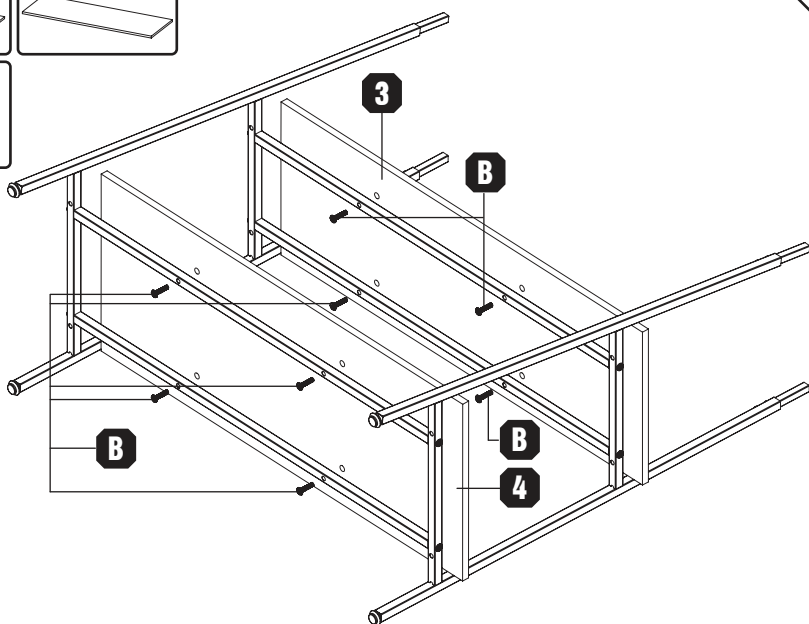
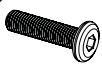

5 1Pc



6 1Pc



B 8Pcs

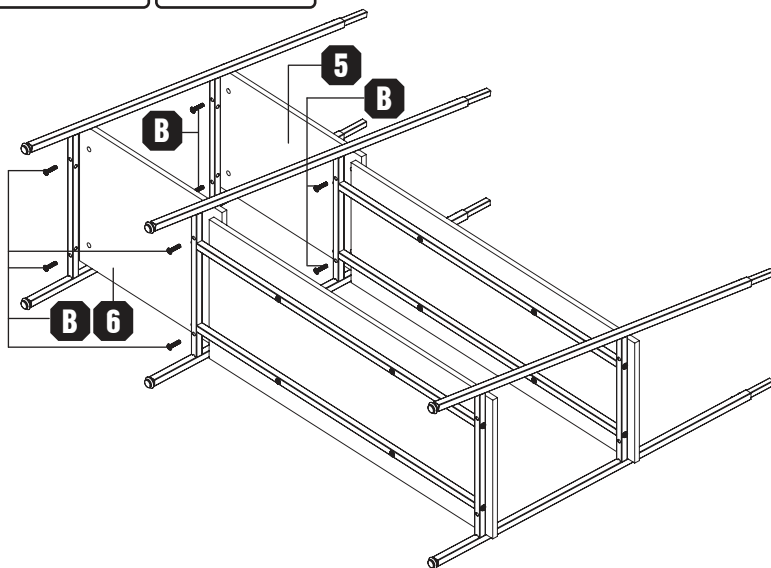

2 2Pcs



10 1Pc

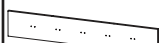

C 4Pcs



D 5Pcs



E 10Pcs

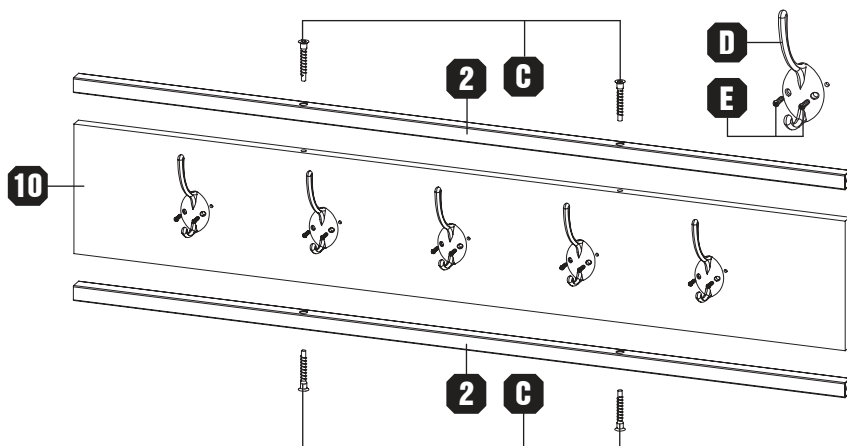

7 1Pc



8 1Pc



9 1Pc



F 12Pcs



M6x10

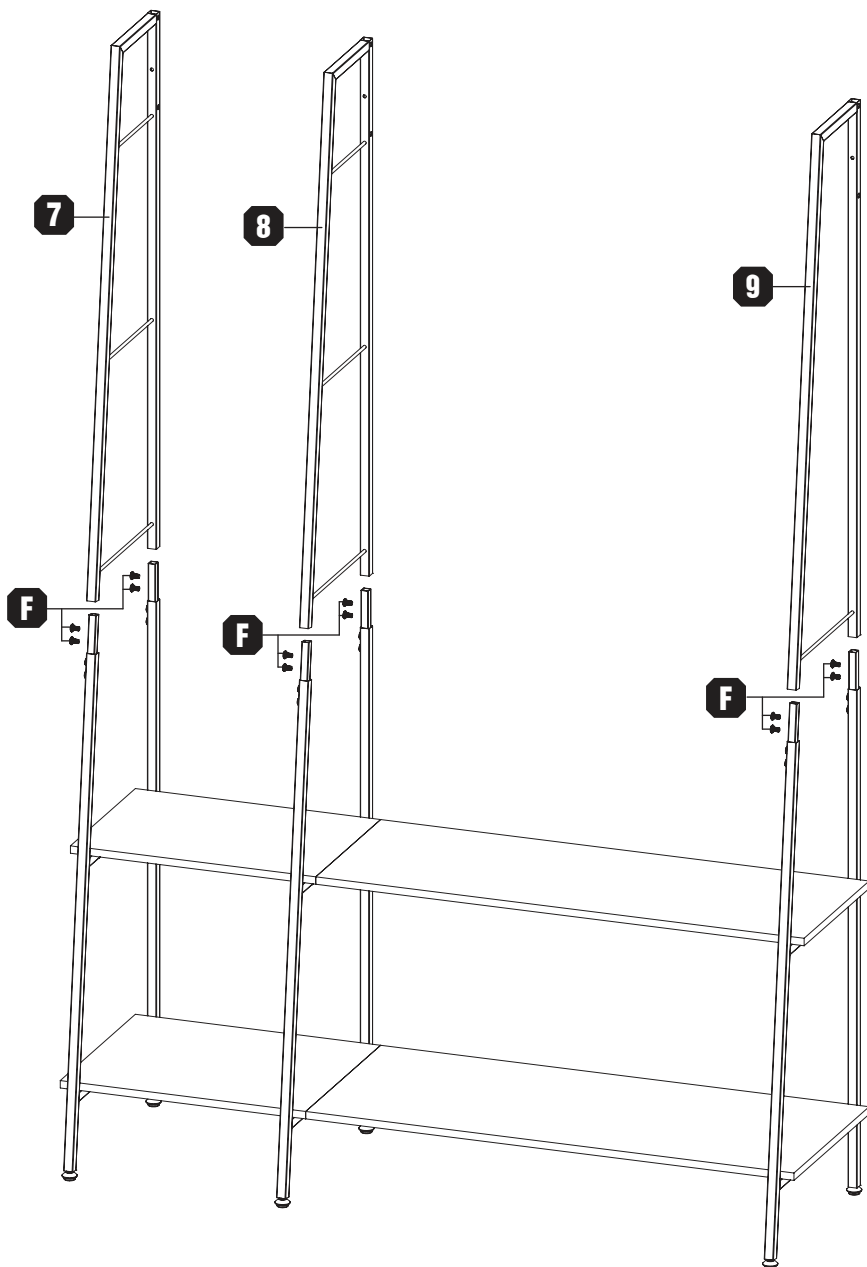

B 3Pcs



H 1Pc

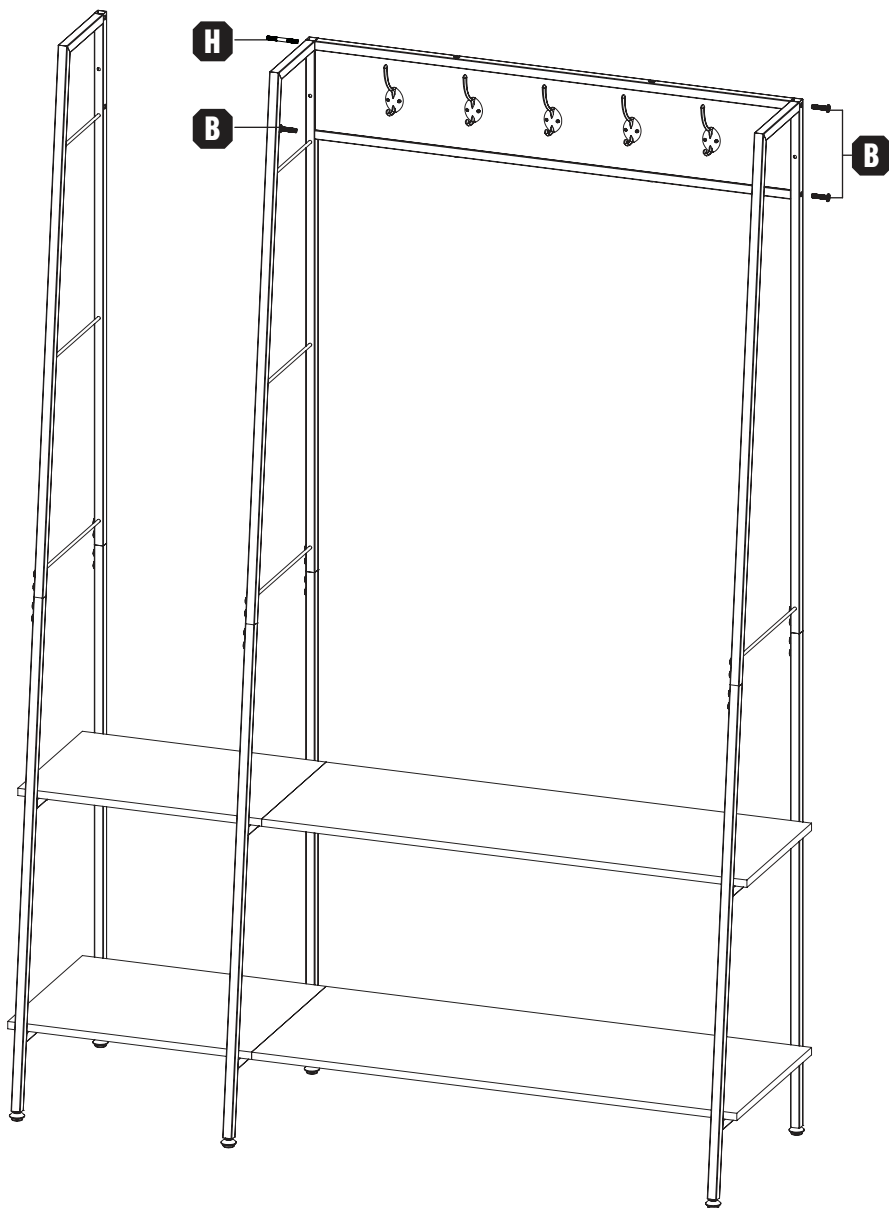

14 1Pc



B 1Pc

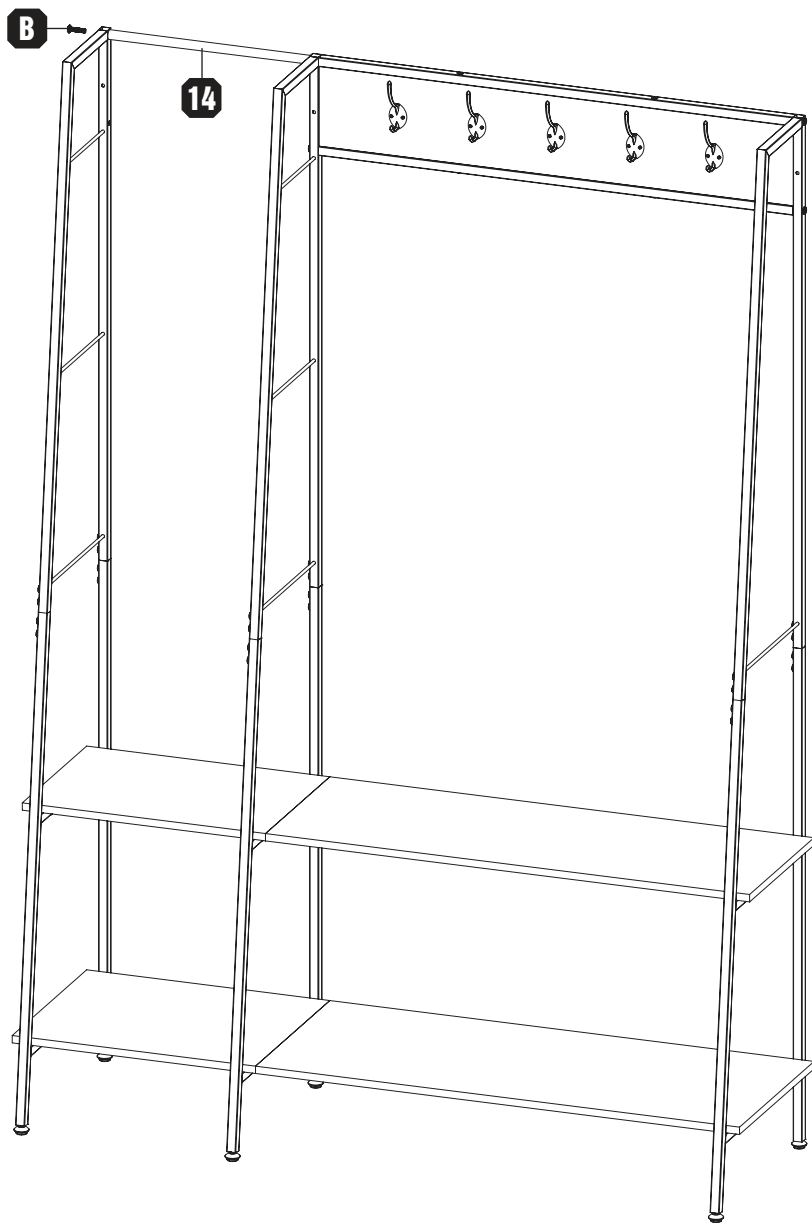

09

11 1Pc



I 4Pcs



J 8Pcs

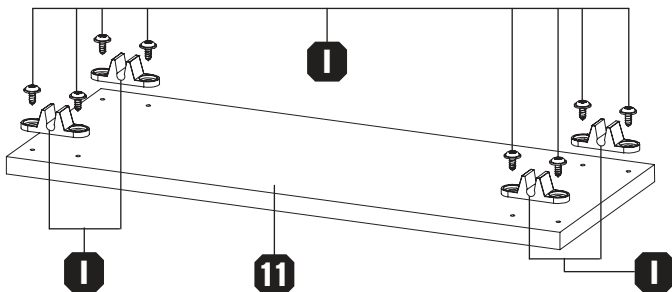

10

12 1Pc



I 4Pcs



J 8Pcs

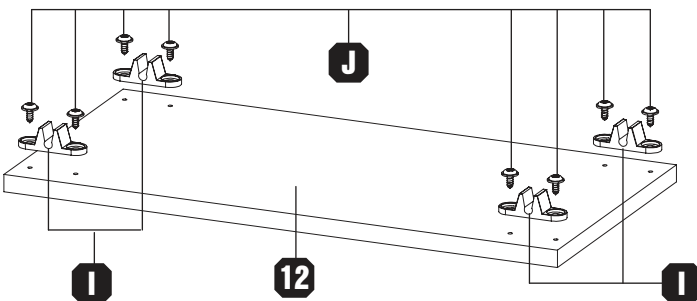

11

13 1Pc



I 4Pcs



J 8Pcs

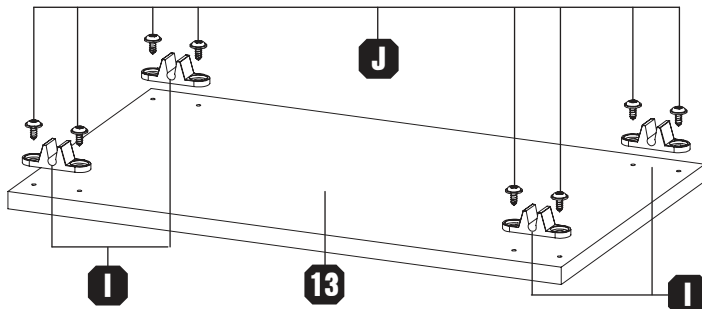

15 2Pcs**F** 1Pc

M6x10

G 4Pcs

M6x12

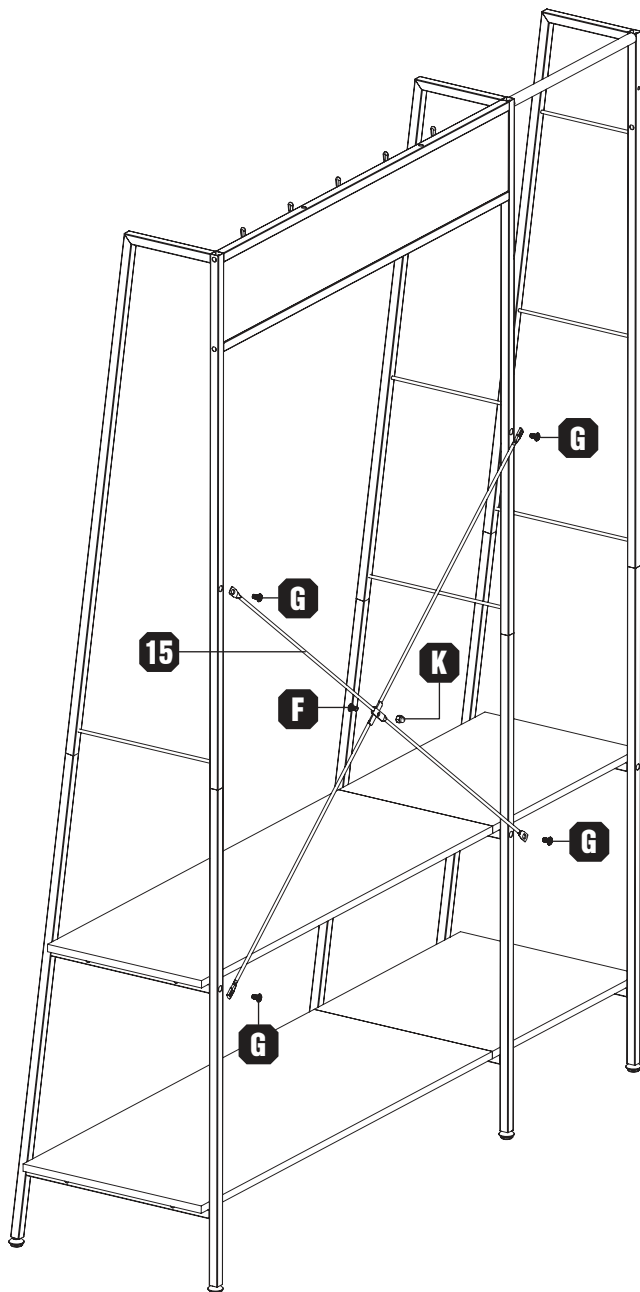
K 1Pc

L 2Pcs

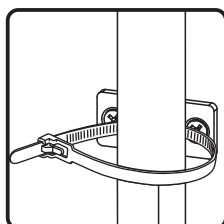
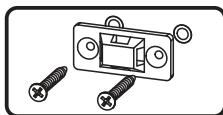
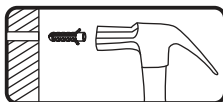
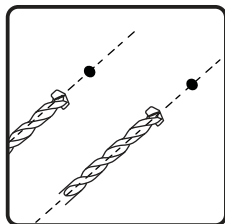
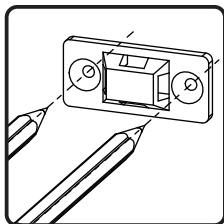
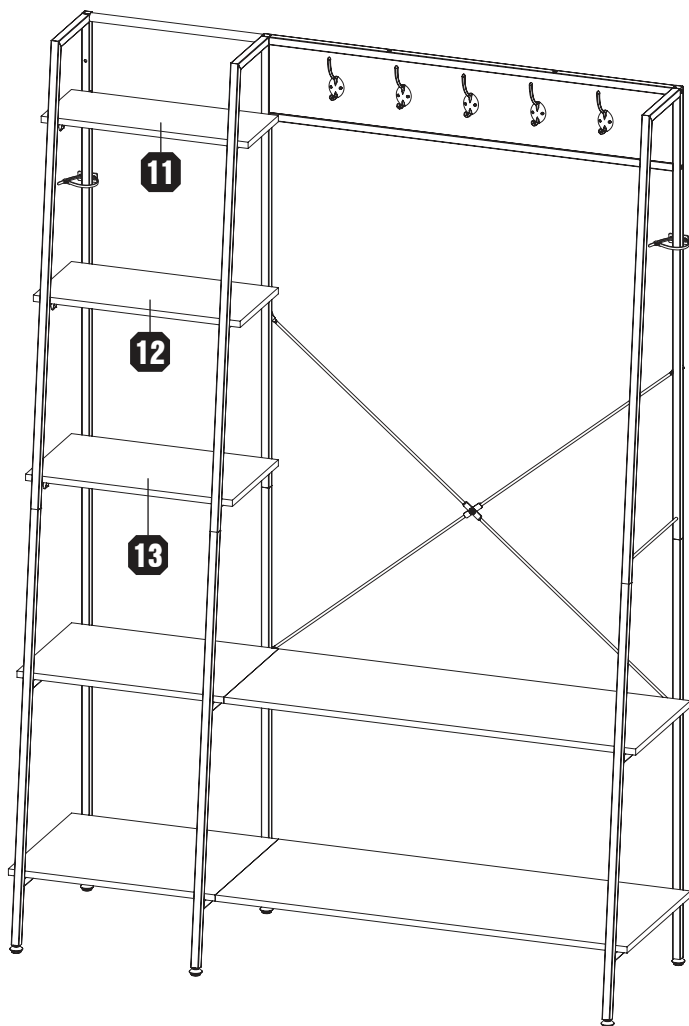
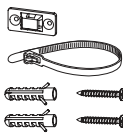

US

Imported by Aosom LLC
 7270 Woodbine Avenue, Unit 307, Markham, Ontario Canada
 L3R 4B9
 MADE IN CHINA

CA

Imported by Aosom Canada Inc.
 7270 Woodbine Avenue, Unit 307, Markham, Ontario Canada
 L3R 4B9
 MADE IN CHINA

Importé par Aosom Canada Inc.
 7270 Woodbine Avenue, unité 307, Markham, Ontario Canada
 L3R 4B9
 Fabriqué en Chine

UK

IMPORTER ADDRESS:
 MH STAR UK LTD
 Unit 27, Perivale Park,
 Horsenden lane South
 Perivale, UB6 7RH
 MADE IN CHINA

FR

ADRESSE D'IMPORTATION:
 MH FRANCE
 2 Rue Maurice Hartmann
 92130 Issy Les Moulineaux
 France
 FABRIQUÉ EN CHINE



FR

Pensez à donner ou recycler.

Association *ou* Magasin *ou* Déchèterie

<https://quefairedemesdechets.fr>

ES

IMPORTADOR:
 SPANISH AOSOM, S.L.
 C/ROC GROS, Nº15.08550, ELS HOSTALET DE BALENYÀ, SPAIN.
 B66295775
 WWW.AOSOM.ES
 ATENCIONCLIENTE@AOSOM.ES
 TEL: 931294512
 HECHO EN CHINA

PT

SPANISH AOSOM, S.L
 C.ROC GROS N.15, 08550. ELS HOSTALET DE BALENYÀ
 TEL: 931294512 (SEG-SEX DAS 7:30H ÀS 16:30H)
 INFO@AOSOM.PT
 WWW.AOSOM.PT

DE

ADRESSE DES IMPORTEURE:
 MH Handel GmbH
 Wendenstraße 309
 D-20537 Hamburg
 Germany
 IN CHINA HERGESTELLT

IT

IMPORTATO DA:
 AOSOM Italy srl
 Centro Direzionale Milanofiori
 Strada 1 Palazzo F1
 20057 Assago (MI)
 P.I.: 08567220960
 FATTO IN CINA