

PawHut

IN230300334V01_GL

D31-012

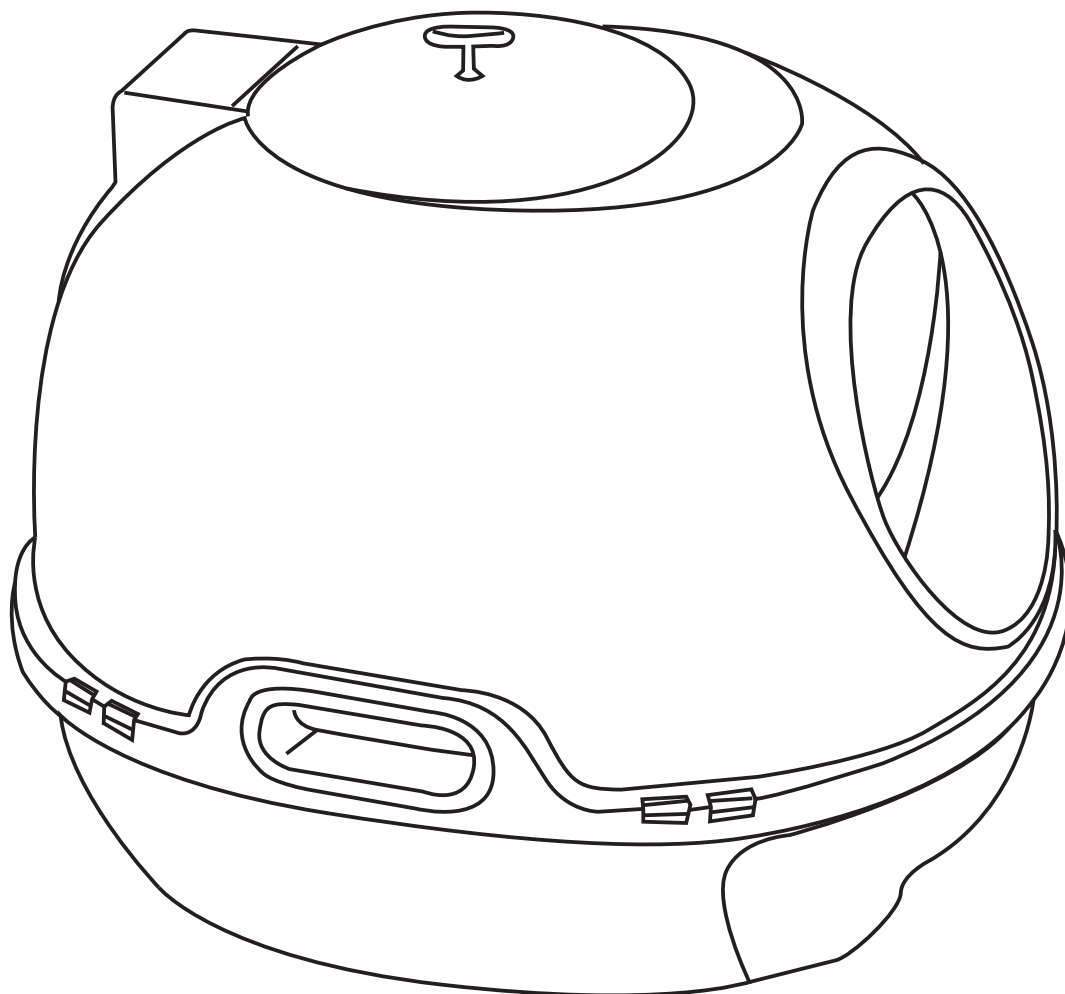

EN_IMPORTANT, RETAIN FOR FUTURE REFERENCE: READ CAREFULLY.

FR_IMPORTANT: A LIRE ATTENTIVEMENT ET À CONSERVER POUR CONSULTATION ULTÉRIEURE.

ES_IMPORTANTE, LEA Y GUARDE PARA FUTURAS REFERENCIAS.

PT_IMPORTANTE, RETER PARA REFERÊNCIA FUTURA: LEIA ATENTAMENTE.

DE_WICHTIG! SORGFÄLTIG LESEN UND FÜR SPÄTER NACHSCHLAGEN AUFBEWAHREN.

IT_IMPORTANTE! CONSERVARE IL PRESENTE MANUALE PER FUTURO RIFERIMENTO E LEGGERLO ATTENTAMENTE.

EN

Dear customer,

Thank you for purchasing this product. So that your appliance serves you well, please read all the instructions in this user's manual. If you have any questions, please contact our customer care center, Our contact details are below:

FR

Cher client,

Nous vous remercions d'avoir acheté ce produit. Afin que vous puissiez profiter pleinement de votre appareil, veuillez lire toutes les instructions de ce manuel d'utilisation. Si vous avez la moindre question, veuillez contacter notre centre d'assistance à la clientèle, Nos coordonnées sont les suivantes:

DE

Sehr geehrter Kunde,

Vielen Dank, dass Sie dieses Produkt erworben haben. Damit Ihr Gerät Ihnen gute Dienste leistet, lesen Sie bitte alle Hinweise in diesem Benutzerhandbuch. Wenn Sie Fragen haben, wenden Sie sich bitte an unser Kundendienstzentrum, Unsere Kontaktdaten stehen unten:

ES

Queridos clientes,

Gracias por comprar este producto. Para que su electrodoméstico le sirva mejor, lea todas las instrucciones de este manual del usuario. Si tiene alguna pregunta, comuníquese con nuestro Centro de Atención al Cliente, Nuestros datos de contacto son los siguientes:

PT

Caros clientes,

Obrigado por adquirir este produto. Para que o seu aparelho o sirva melhor, leia todas as instruções deste manual do utilizador. Se tiver alguma dúvida, por favor contacte o nosso Centro de Atendimento ao Cliente, Os nossos dados de contacto são os seguintes:

IT

Caro Cliente,

Grazie per aver acquistato questo prodotto. Per servirti meglio con questo apparecchio ti prego di leggere tutte le istruzioni in presente manuale utente. In caso di dubbio, si prega di contattare il nostro centro assistenza clienti, I nostri dettagli di contatto sono di seguito:

Country	 Phone	 Email
US	001-877-644-9366	customerservice@aosom.com
CA	416-792-6088	customerservice@aosom.ca
UK	0044-800-240-4004	enquiries@mhstar.co.uk
DE	0049-0(40)-88307530	service@aosom.de
FR	0033-1-84166106	aosom@mhfrance.fr
ES	0034-931294512	atencioncliente@aosom.es
PT	0034-931294512	info@aosom.pt
IT	0039-0249471447	clienti@aosom.it

A x1

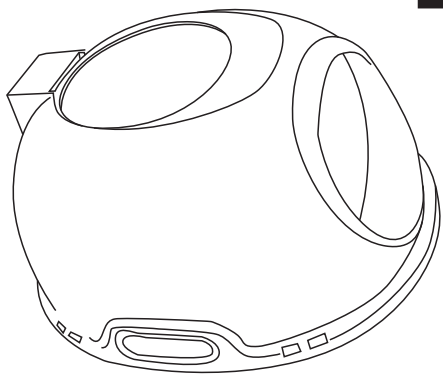

B x1

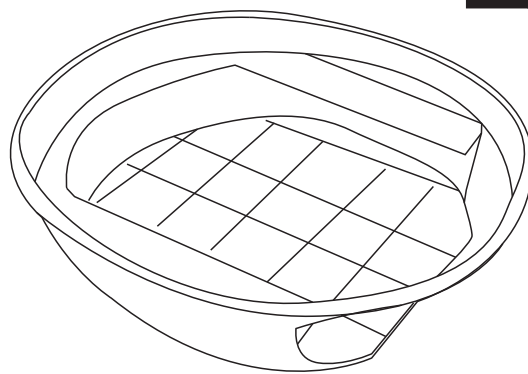

C x1

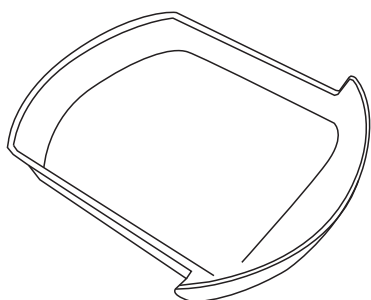

D x1

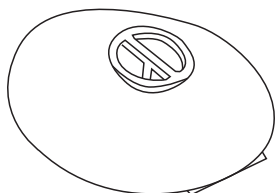

E x1

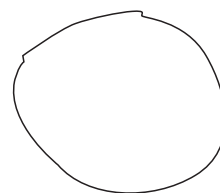

F x2

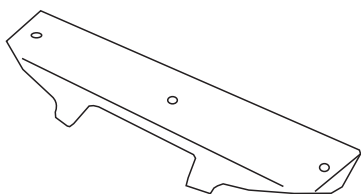

G x2

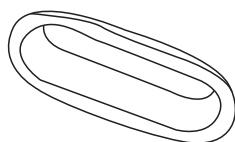

H x1

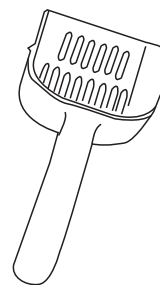

I x1

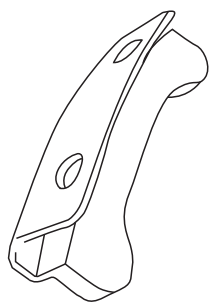

J x4



K x1

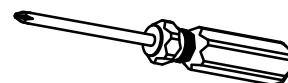

01

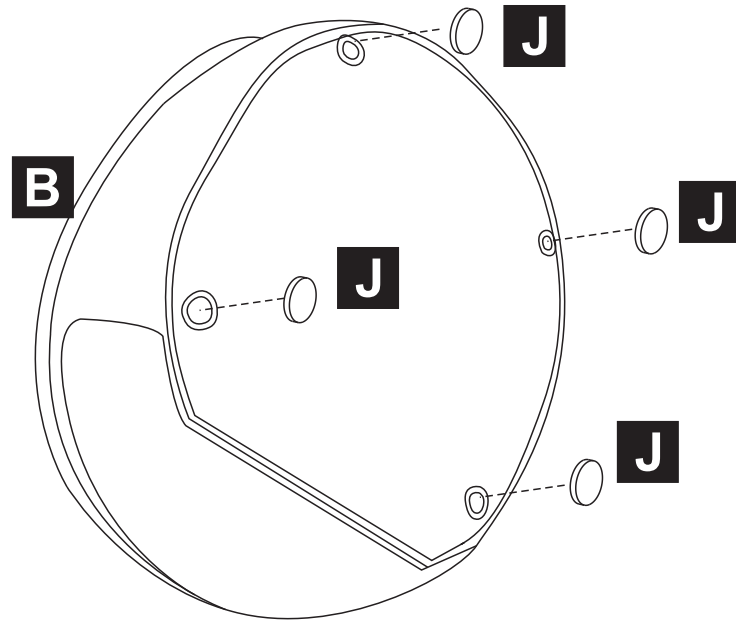

02

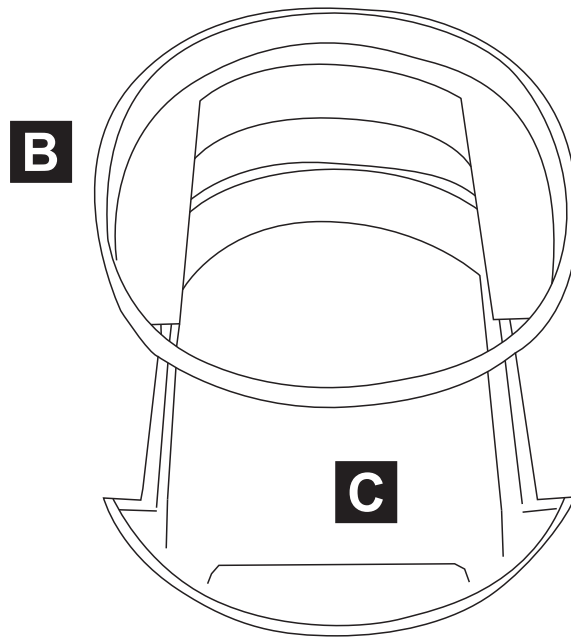

03

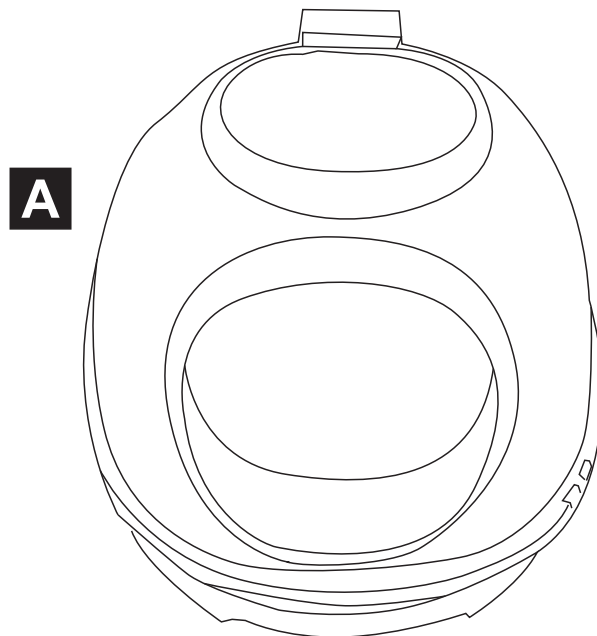

04

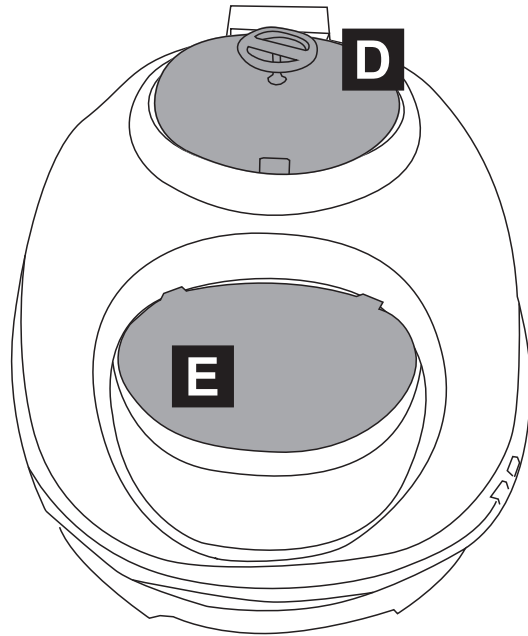

05

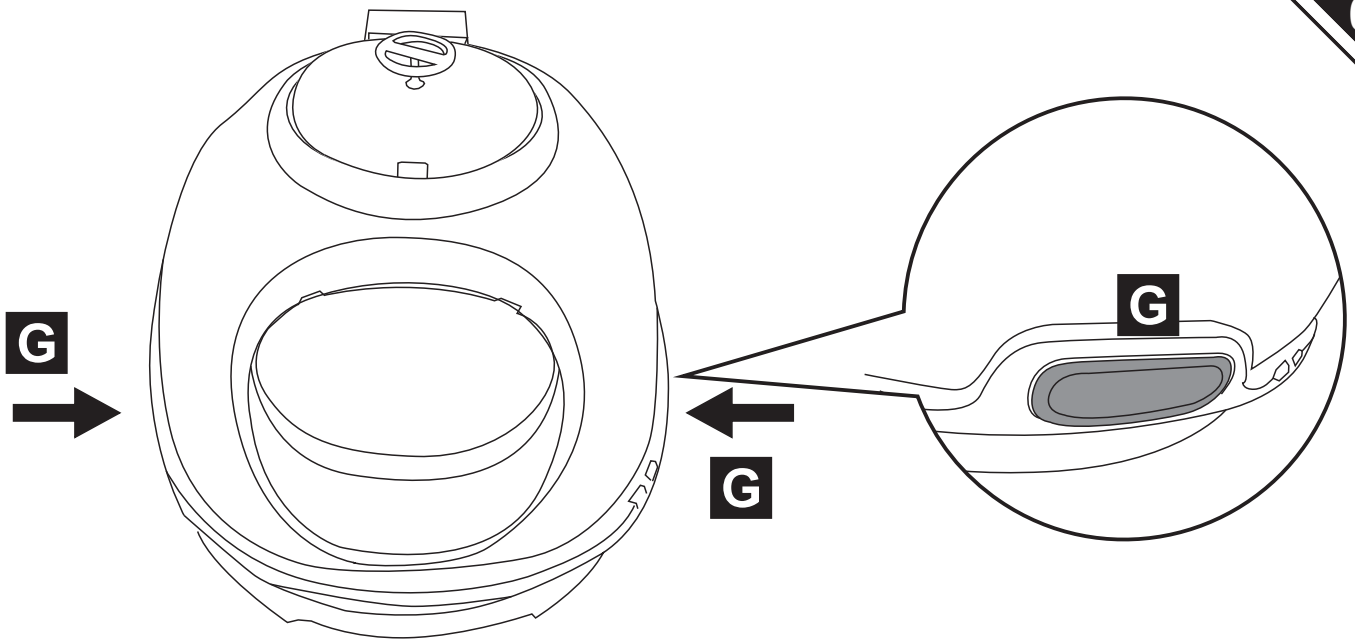

06

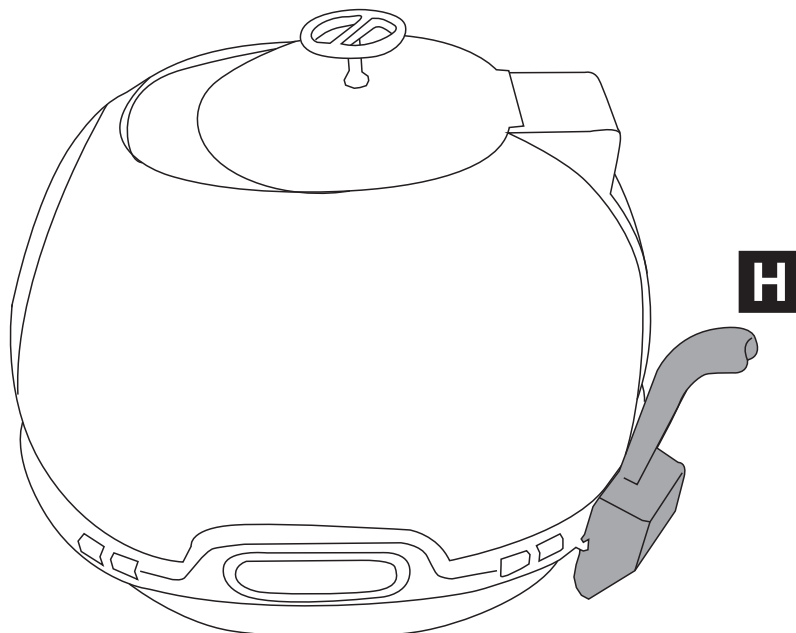

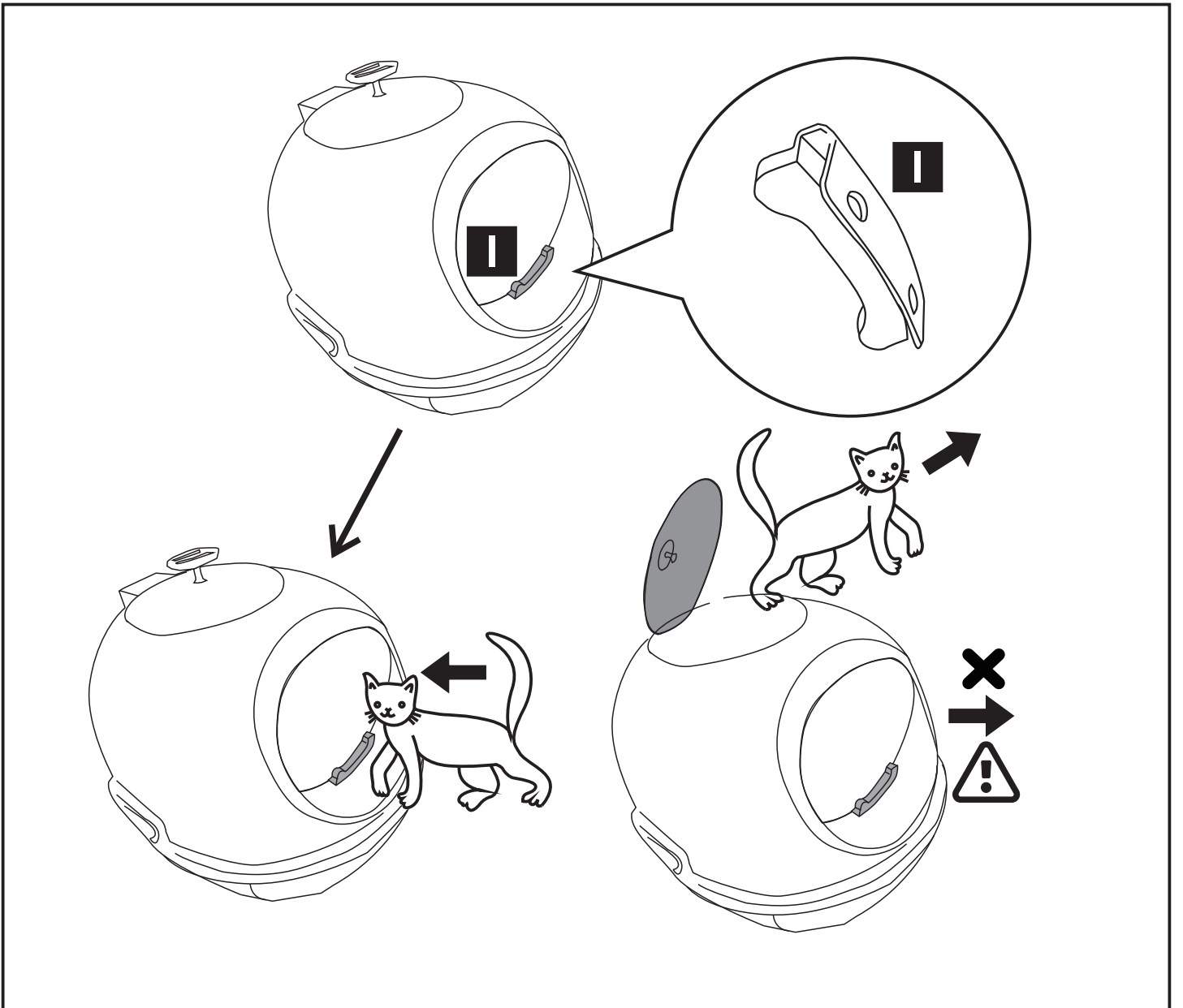
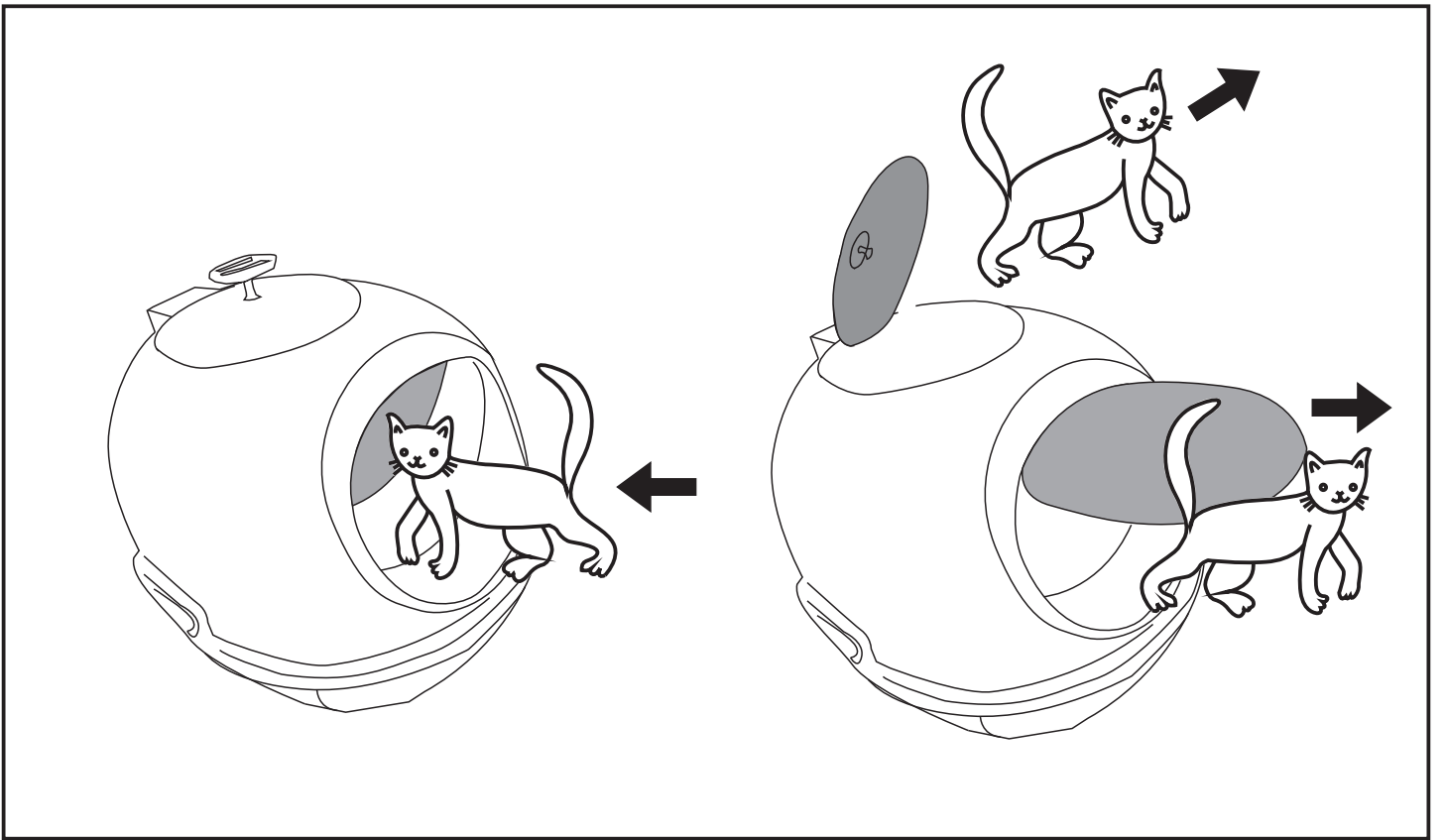

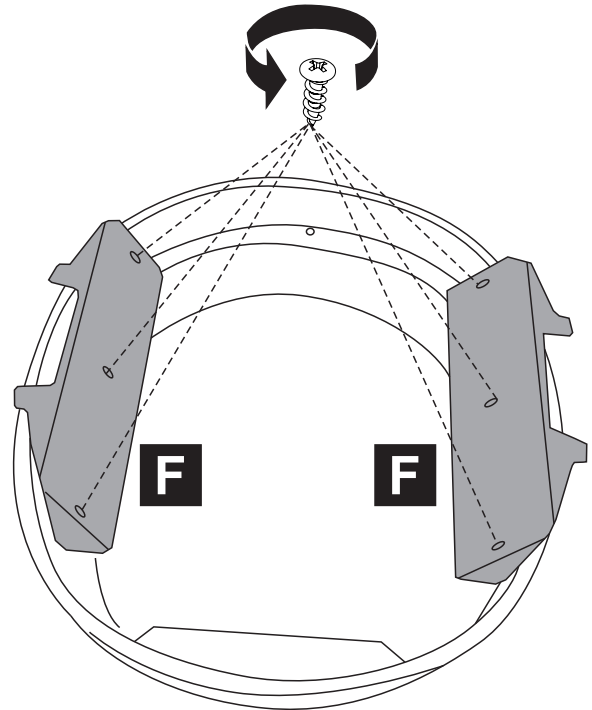
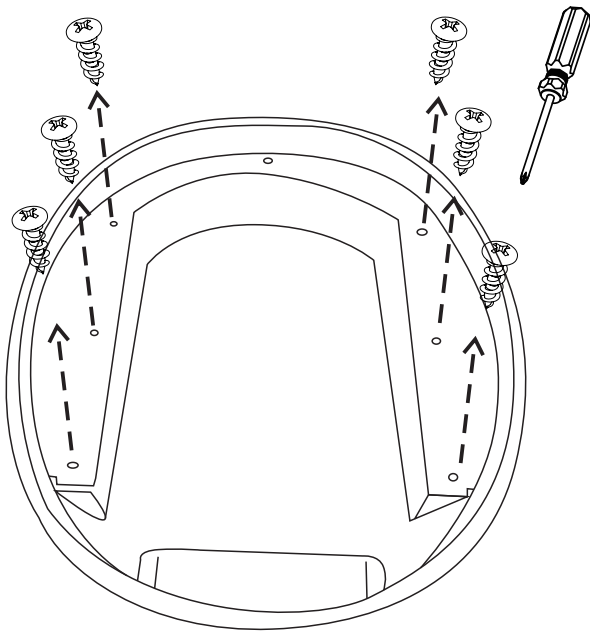

EN_Warm tips: Choose to install this accessory according to your pet's toilet habit

Function: To prevent cats from defecating outside of the toilet

Installation Procedures:

Step 1: Unscrew the 6 screws on two sides of tray;

Step 2: Align the accessory with holes on the tray, tighten the screws.

FR_Remarque: Déterminez si vous souhaitez installer cet accessoire en fonction des habitudes de toilette de votre animal.

Fonction: Empêcher le chat de tirer son caca des deux côtés de la toilette

Installation: Step 1 dévissez les six vis au dessous du bac;

Step 2 Alignedz les trous d'accessoire avec le plaque au fond du bac, revisser les vis.

ES_Consejos: Elija instalar este accesorio de acuerdo con los hábitos de aseo de su mascota.

Rol: Evita que las mascotas tomen caca a ambos lados del inodoro.

Instalación:

paso 1 desenrosca 6 tornillos en ambos lados del fondo

paso 2 coloca el dispositivo, alinee la posición del orificio del tornillo del tablero de arena del pedestal y atornille el tornillo.

PT_Pontas quentes: Escolha instalar este acessório de acordo com o hábito da casa de banho do seu animal

Função: Para evitar que os gatos defecam fora da sanita

Procedimentos de Instalação:

Passo 1: Desaparafusar os 6 parafusos em dois lados do tabuleiro;

Passo 2: Alinhar o acessório com orifícios na bandeja, apertar os parafusos.

DE_Tipps

Sie können sich nach der Toilettengewohnheit Ihres Haustiers entscheiden, ob Sie das Zubehörset montieren

Funktion : Um zu verhindern, dass Katzen außerhalb der Toilette scheißen.

Montage : Schritt 1 Lösen Sie die 6 Schrauben an beiden Seiten des Beckenbodens

Schritt 2 Richten Sie das Set auf die Bohrlöcher des Beckenbodens, und ziehen Sie die Schrauben fest.

IT_Consigli d'uso: Scegli tu come installare questo accessorio in base alle esigenze e alle abitudini del tuo

gatto. Funzione: Contenere lo sporco per una maggiore igiene in casa.

Installazione:

1. Svita le 6 viti sui lati della vaschetta.

2. Allinea l'accessorio ai fori presenti sulla vaschetta, e fissalo usando le viti.

US

Imported by Aosom LLC
27150 SW Kinsman Rd Wilsonville, OR 97070 USA
MADE IN CHINA

CA

Imported by Aosom Canada Inc.
7270 Woodbine Avenue, Unit 307, Markham, Ontario Canada
L3R 4B9
MADE IN CHINA

Importé par Aosom Canada Inc.
7270 Woodbine Avenue, unité 307, Markham, Ontario Canada
L3R 4B9
Fabriqué en Chine

UK

IMPORTER ADDRESS:
MH STAR UK LTD
Unit 27, Perivale Park,
Horsenden lane South
Perivale, UB6 7RH
MADE IN CHINA

FR

ADRESSE D'IMPORTATION:
MH FRANCE
2 Rue Maurice Hartmann
92130 Issy Les Moulineaux
France
FABRIQUÉ EN CHINE

ES

IMPORTADOR:
SPANISH AOSOM, S.L.
C/ROC GROS,Nº15.08550, ELS HOSTALET DE BALENYÀ, SPAIN.
B66295775
WWW.AOSOM.ES
ATENCIONCLIENTE@AOSOM.ES
TEL: 931294512
HECHO EN CHINA

PT

SPANISH AOSOM, S.L
C.ROC GROS N.15, 08550. ELS HOSTALET DE BALENYÀ
TEL: 931294512 (SEG-SEX DAS 7:30H ÀS 16:30H)
INFO@AOSOM.PT
WWW.AOSOM.PT

DE

ADRESSE DES IMPORTEURS:
MH Handel GmbH
Wendenstraße 309
D-20537 Hamburg
Germany
IN CHINA HERGESTELLT

IT

IMPORTATO DA:
AOSOM Italy srl
Centro Direzionale Milanofiori
Strada 1 Palazzo F1
20057 Assago (MI)
P.I.: 08567220960
FATTO IN CINA