

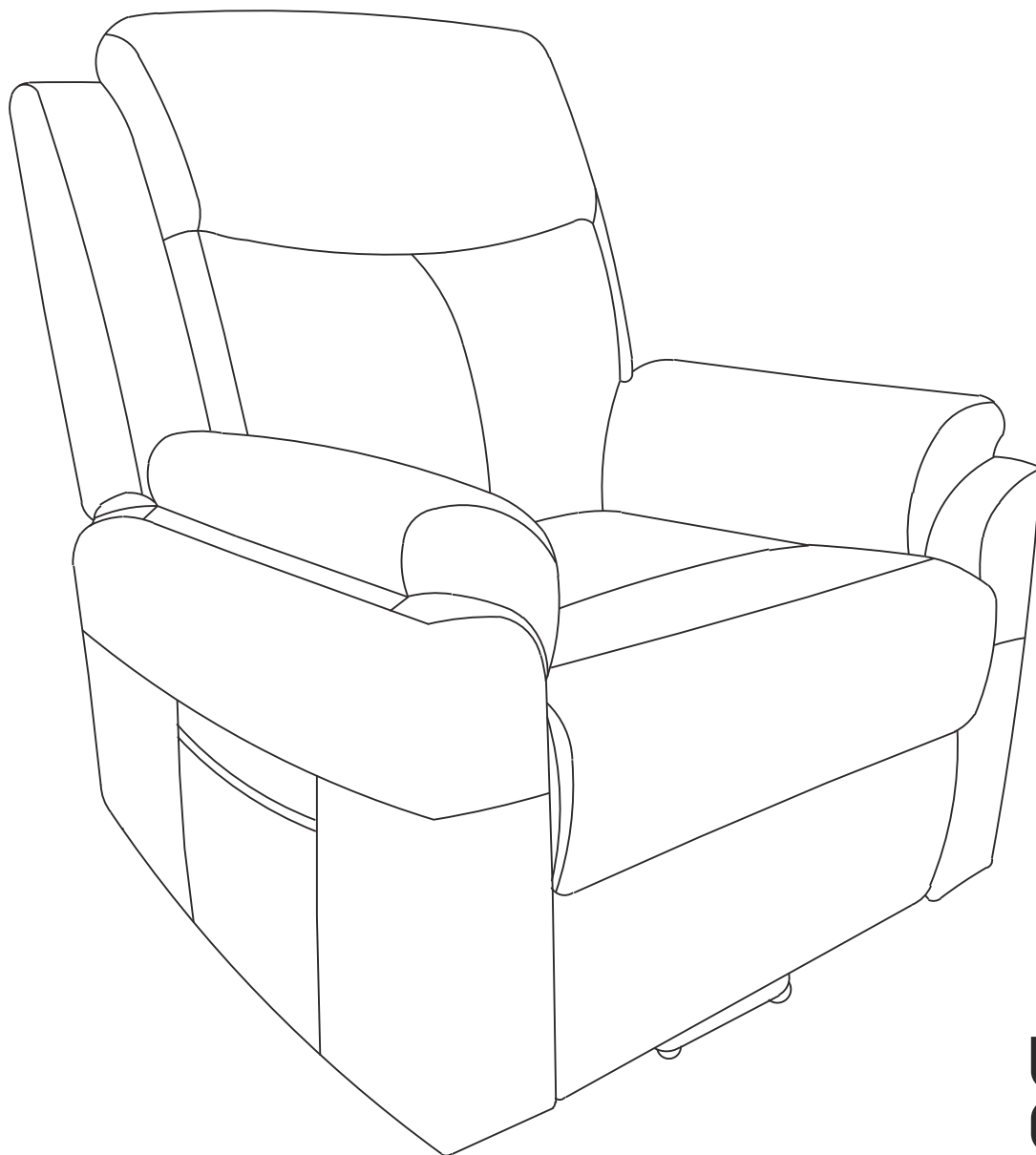

IN230400383V01_UK

713-094V71



**UK
CA
CE**

IMPORTANT, RETAIN FOR FUTURE REFERENCE: READ CAREFULLY

ASSEMBLY INSTRUCTION

Chairs, Sofas and Armchairs

IMPORTANT, RETAIN FOR FUTURE REFERENCE: READ CAREFULLY

Only for domestic use

Instructions for use:

- *Put the chair stably on a flat floor.
- *Building the chairs in good condition.
- *Stay away from open flames.
- *Avoid the overload at the chair.

Precautions before assembly:

- *Prepare a clean and dry mounting area.
- *Verify that the product is not damaged.
- *Check that none of the pieces are missing.

Maintenance:

- *Clean with a soft fabric.
- *Regularly remove leaves and / or water collected on the canvas.
- *Check the seating regularly.

Storage conditions:

*The fabric should be stored completely dry, in a clean and dry place to avoid the risks of mold.

Beware of crushing and cutting hazards during assembly.

The manufacturer declines all responsibility in case of damages due to a bad installation or withering.

If the seating is fitted with powered seat height adjustments, only trained personnel may replace or repair those components.

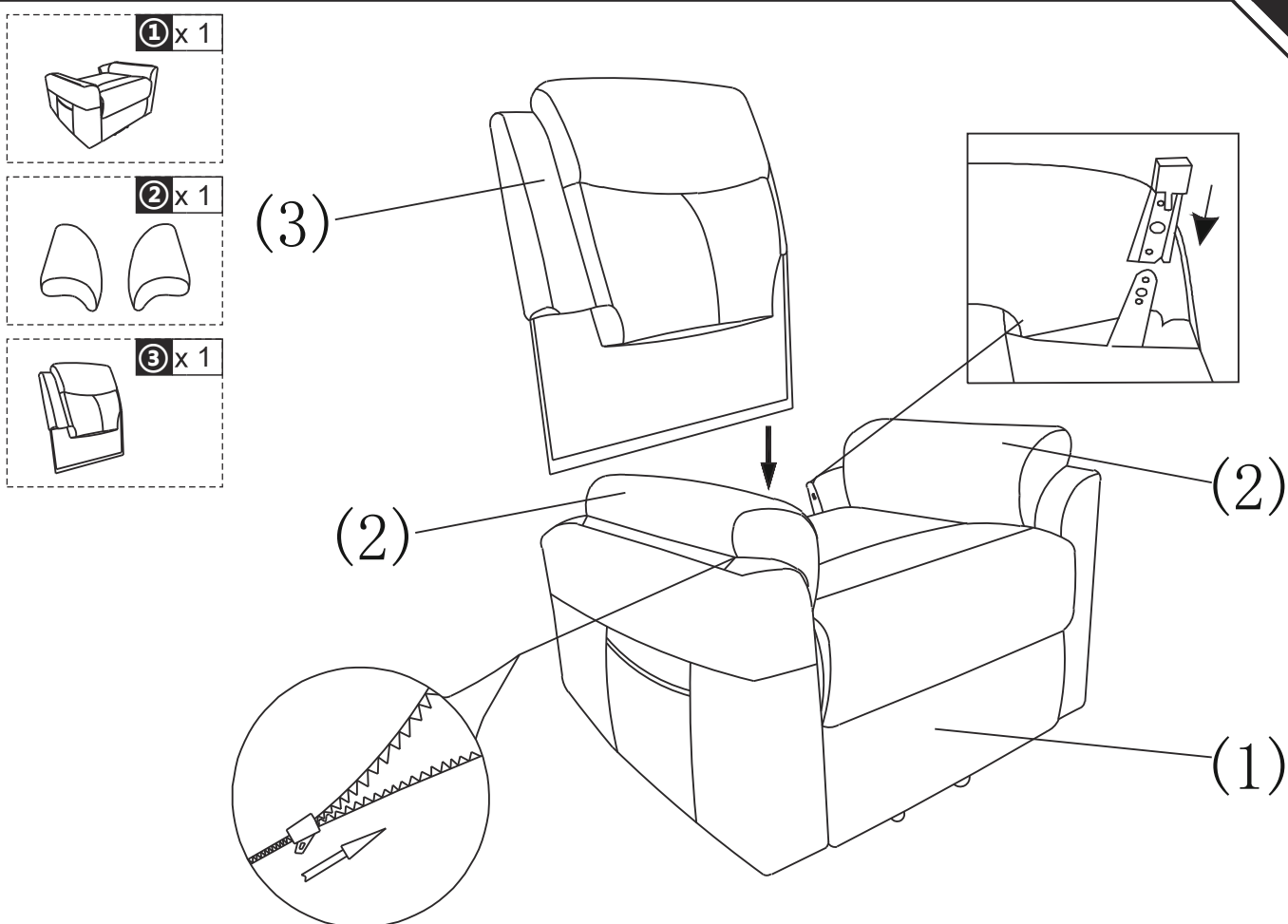
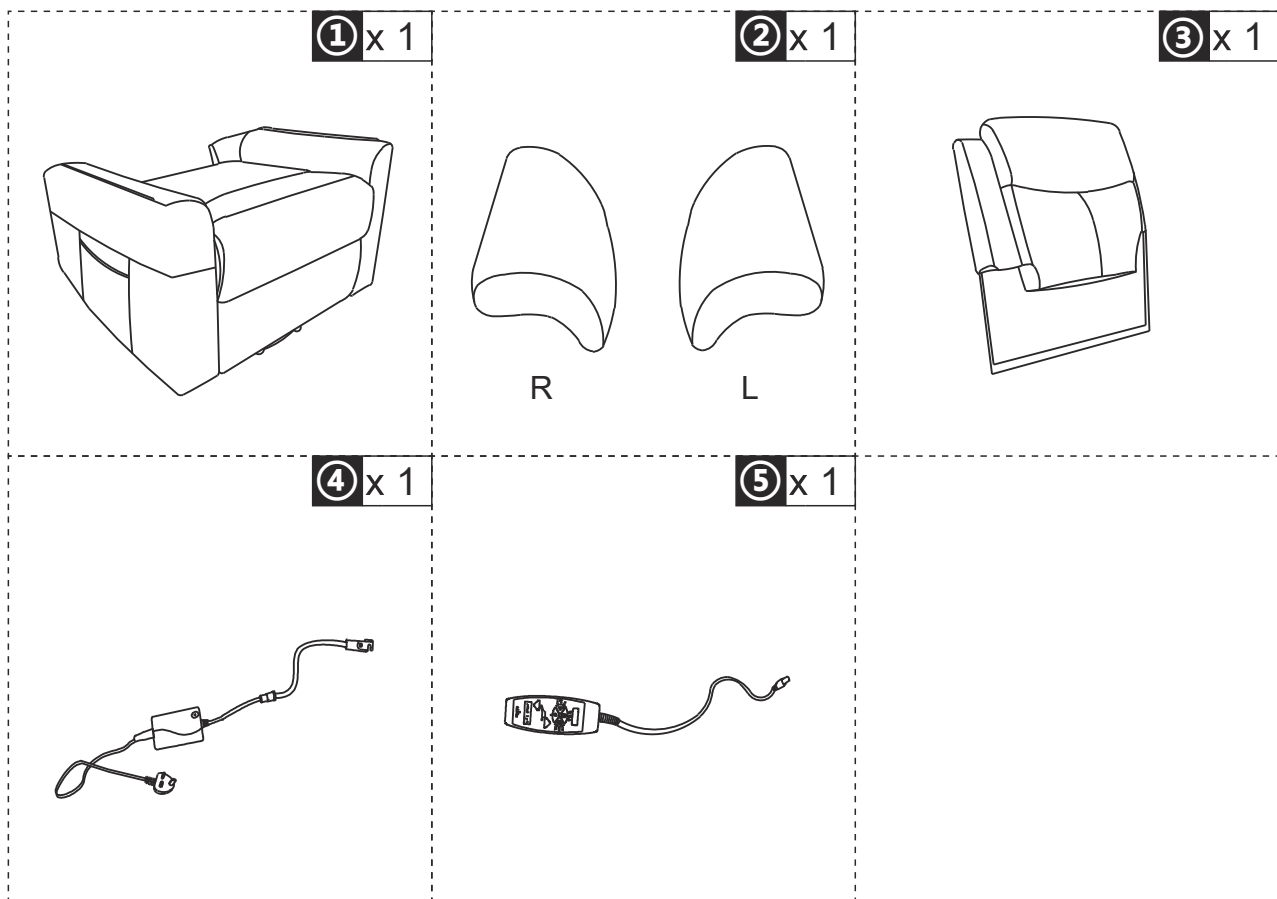

④ x 1

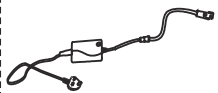

⑤ x 1

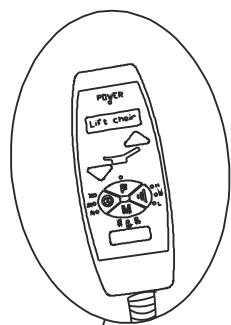
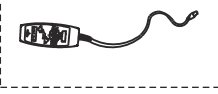

(4)

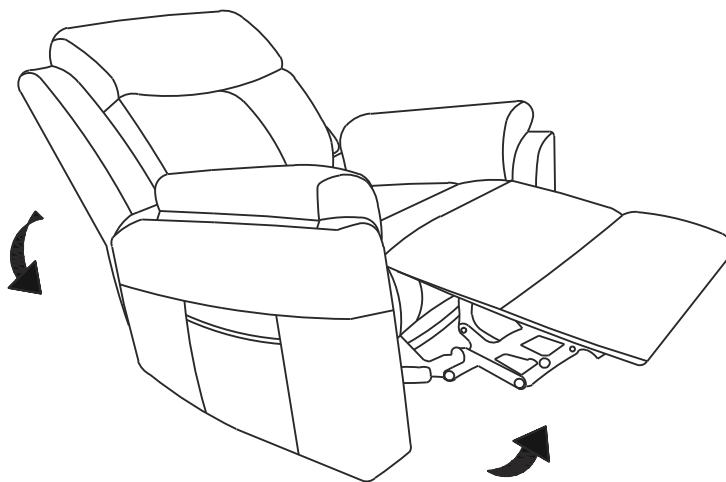
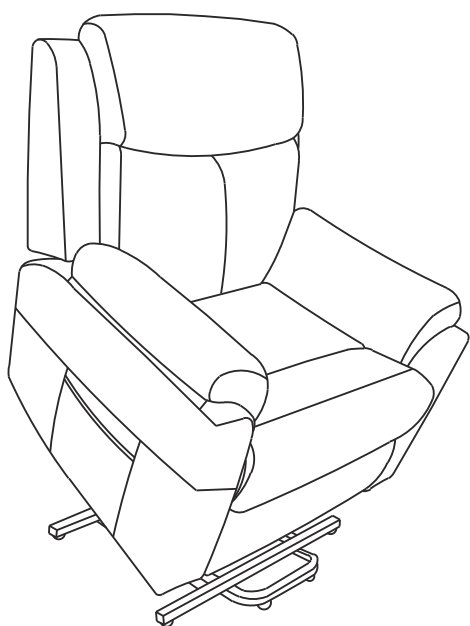
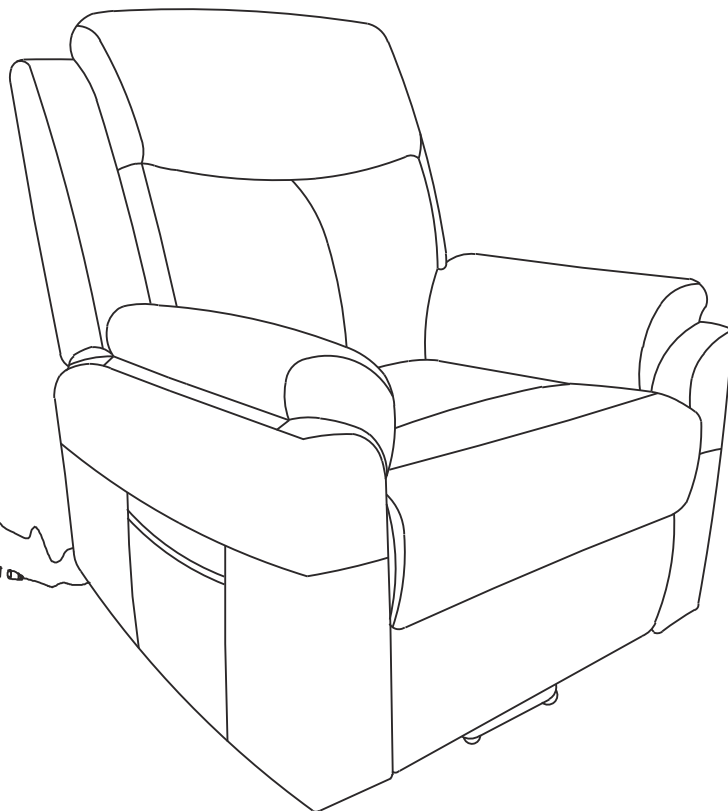
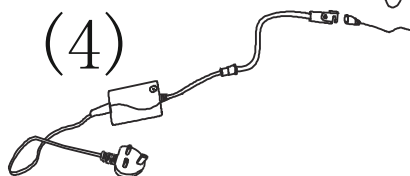

Function Including:

Lift motor +vibration massage

Tech Specs.:

- 1.Voltage: AC100-240V DC29V 2A UL
- 2.Power: 58W
- 3.Frequency: 50/60HZ
- 4.Timer: 10-30Min / Massage Self-closing





Operation instructions

First of all, check if local voltage is consistent with the transformer power supply, If available, then plug in, to set up an electric circuit.

The top of the hand controller comes with a USB port to facilitate charging of electronic products such as mobile phones.

1. Product require DC 29V Power, Boot indicator light up after electrify;

2.  Up arrow button: should keep pressing to work, the chair will get down, then unfold to max recliner position.

3.  Down arrow button: should keep pressing to work, the back & footrest will revover, then lift up to top position.

4. **P** Positioning key, when you press for each time, from the back, lumbar、 thigh,leg (reserved for this position) and other four parts , you can circularly choose the massage position.

5.  "Time" key: timing regulation key. Press "10-20-30" to regulate the time and the corresponding mode indication lamp will be on.

6.  "Intensity" key: it has three-gear strength regulation key H-M-L. Press the key, the strength indication lamp will flicker and the strength will change as per the sequence: M-L-H cycling.

7. **M** "Mode" key: it has three-mode switchover key. When the vibrating motor is in a start state, the key can realize vibrating mode switchover,suchas M1→M2→M3→M1.....and the corresponding indication lamp will be on in certain mode.

8.  Power On / Off, vibration massage power.

If you have any questions, please contact our customer care center.

Our contact details are below:



0044-800-240-4004



enquiries@mhstar.co.uk

IMPORTER ADDRESS:
MH STAR UK LTD
Unit 27, Perivale Park,
Horsenden lane South
Perivale, UB6 7RH
MADE IN CHINA