

EN_IMPORTANT, RETAIN FOR FUTURE REFERENCE: READ CAREFULLY.

FR_IMPORTANT: A LIRE ATTENTIVEMENT ET À CONSERVER POUR CONSULTATION ULTÉRIEURE.

ES_IMPORTANTE, LEA Y GUARDE PARA FUTURAS REFERENCIAS.

PT_IMPORTANTE, RETER PARA REFERÊNCIA FUTURA: LEIA ATENTAMENTE.

DE_WICHTIG! SORGFÄLTIG LESEN UND FÜR SPÄTER NACHSCHLAGEN AUFBEWAHREN.

IT_IMPORTANTE! CONSERVARE IL PRESENTE MANUALE PER FUTURO RIFERIMENTO E LEGGERLO ATTENTAMENTE.

IMPORTANT, RETAIN FOR FUTURE REFERENCE: READ CAREFULLY.

Only for domestic use

Instructions for use:

- *Put the chair stably on a flat floor.
- *Stay away from open flames.
- *Avoid the overload at the chair.

Precautions before assembly:

- *Prepare a clean and dry mounting area.
- *Verify that the product is not damaged.
- *Check that none of the pieces are missing.

Maintenance:

- *Clean with a soft fabric.
- *Check the seating regularly.

Storage conditions:

- *The fabric should be stored completely dry, in a clean and dry place to avoid the risks of mold.

Beware of crushing and cutting hazards during assembly.

The manufacturer declines all responsibility in case of damages due to a bad installation or withering.

If the seating is fitted with powered seat height adjustments, only trained personnel may replace or repair those components.

IMPORTANT: A LIRE ATTENTIVEMENT ET À CONSERVER POUR CONSULTATION ULTÉRIEURE.

Réservé à un usage domestique

Conseils :

- *Placez la chaise sur un sol plat et sec afin qu'elle soit stable
- *Placer à l'écart des flammes ou de sources de chaleur
- *Ne pas dépasser la charge maximale autorisée

Précautions avant l'assemblage :

- *Préparez une zone de montage propre et sèche
- *Vérifiez que le produit n'est pas endommagé
- *Vérifiez qu'aucune des pièces de ne manque

Recommandations d'entretien :

- *Veuillez utiliser un chiffon doux pour essuyer la chaise
- *Vérifiez régulièrement la structure du produit

Conditions de stockage:

- *Veuillez stocker le produit dans un environnement propre et sec pour éviter tout risque de moisissure.

Veillez faire attention à ne pas vous blesser lors de l'assemblage du produit.

Le fabricant n'est pas responsable des dommages causés par une mauvaise installation.

Si le fauteuil est équipé d'un dispositif de hauteur réglable avec moteur, seule une personne qualifiée peut remplacer ou réparer la partie motorisée.

IMPORTANTE, LEA Y GUARDE PARA FUTURAS REFERENCIAS.

Producto para uso doméstico

Consejos de uso:

- * Coloque el producto sobre un suelo plano de forma estable.
- * Manténgase alejado de fuentes de calor y llamas.
- * Evite la sobrecarga de los anclajes del producto.

Precauciones antes del montaje:

- * Prepare la zona de montaje. Asegúrese de que esté limpia y seca.
- * Asegúrese de que el producto está en buen estado.
- * Verifique que no falta ninguna de las piezas.

Mantenimiento:

- * Limpie el producto con la ayuda de un paño suave.
- * Inspeccione el producto de forma regular a fin de detectar posibles daños o desperfectos que puedan afectar a su uso.

Condiciones de almacenaje:

- * A fin de evitar la aparición de moho, los tejidos se deben de guardar totalmente secos y en un lugar limpio y sin humedad.

Atención:

Riesgo de pinzamientos o cortes durante el montaje.

El fabricante declina toda responsabilidad en caso de deterioro debido a una mala instalación o por causas meteorológicas.

Si el producto está equipado con algún mecanismo eléctrico de ajuste de altura o similar, solo podrá ser reemplazado o reparado por personal capacitado y técnicos.

IMPORTANTE, RETER PARA REFERÊNCIA FUTURA: LEIA ATENTAMENTE.

Produto para uso doméstico

Conselhos de uso:

- * Coloque o produto sobre um solo plano e estável.
- * Mantenha-o afastado de fontes de calor e chamas.
- * Evite a sobre carga das fixações do produto.

Precauções antes da montagem:

- * Prepare a zona de montagem. Certifique-se de que esteja limpa e seca.
- * Certifique-se que o produto esteja em bom estado.
- * Verifique que não falte nenhuma das peças.

Manutenção:

- * Limpar o produto com a ajuda de um pano suave.
- * Inspeccionar o produto de forma regular a fim de detectar possíveis defeitos que possa afetar seu uso.

Condições de armazenamento:

- * A fim de evitar a aparecimento de mofo, os tecidos se devem guardar totalmente secos e em um lugar limpo e sem umidade.

Atenção:

Risco de cortes durante a montagem. O fabricante declina toda responsabilidade no caso de deterioração devido uma má instalação ou por causas meteorológicas.

Se o produto estiver equipado com algum mecanismo elétrico de ajuste de altura ou similar, somente poderá ser substituído ou reparado por uma pessoa qualificada ou técnicos.

WICHTIG! SORGFÄLTIG LESEN UND ZUM SPÄTEREN NACHSCHLAGEN AUFBEWAHREN.

Ausschließlich für den häuslichen Gebrauch bestimmt Nutzungshinweise:

- *Bitte stellen Sie den Stuhl stabil auf eine ebene Fläche.
- *Von offenen Feuerquellen fernhalten.
- *Vermeiden Sie eine Überlastung des Stuhls.

Vorsichtsmaßnahmen vor der Montage:

- *Bitte bereiten Sie einen sauberen und trockenen Montagebereich vor.
- *Stellen Sie sicher, dass das Produkt nicht beschädigt ist.
- *Vergewissern Sie sich, dass kein Zubehörteil fehlt.

Instandhaltung:

- *Bitte reinigen Sie den Stuhl nur mit einem weichen Tuch.
- *Überprüfen Sie den Stuhl regelmäßig.

Lagerung:

- *Der Stoff sollte an einem völlig trockenen und sauberen Ort aufbewahrt werden, um Schimmel zu vermeiden.

Vorsicht vor Quetsch- und Schnittgefahr bei der Montage.

Der Hersteller lehnt jegliche Haftung für Schäden ab, die aufgrund unsachgemäßer Montage oder Witterungseinflüsse verursacht werden. Falls der Stuhl mit einer elektronischen Höhenverstellung geliefert wird, dürfen Reparaturarbeiten nur von qualifiziertem Personal durchgeführt werden.

IMPORTANTE! CONSERVARE IL PRESENTE MANUALE PER FUTURO RIFERIMENTO E LEggerlo ATTENTAMENTE.

Solo per uso domestico

Istruzioni per l'uso:

*Posizionare la sedia in maniera stabile su un pavimento in piano.

*Tenere lontano dalle fiamme vive.

*Evitare di sovraccaricare la sedia.

Precauzioni prima del montaggio:

*Preparare un'area di montaggio sgombra e asciutta.

*Verificare che il prodotto non sia danneggiato.

*Verificare che non manchi nessun pezzo.

Manutenzione:

*Pulire con un tessuto morbido.

*Controllare regolarmente il sedile.

Condizioni di stoccaggio:

*Il tessuto deve essere conservato completamente asciutto, in un luogo pulito e asciutto per evitare la formazione di muffa.

Fare attenzione al rischio di schiacciamento e di taglio durante le fasi di montaggio.

Il produttore declina ogni responsabilità in caso di danni dovuti ad un'installazione incorretta o alle intemperie.

Se la sedia è dotata di un'unità di regolazione elettrica dell'altezza del sedile, solo il personale qualificato può sostituire o riparare questi componenti elettrici.

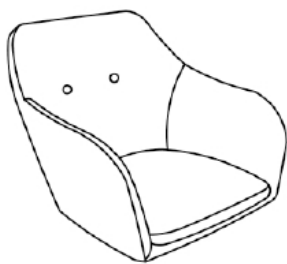
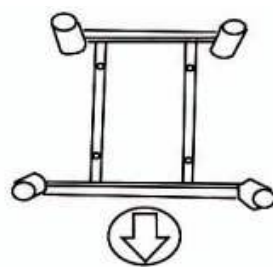
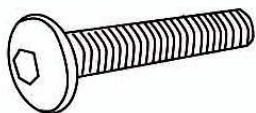
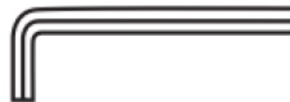
A x 1**B** x 4**C** x 1**D** x 4M6*45
+1(spare)**E** x 1

M6

E 
 **100% D** 

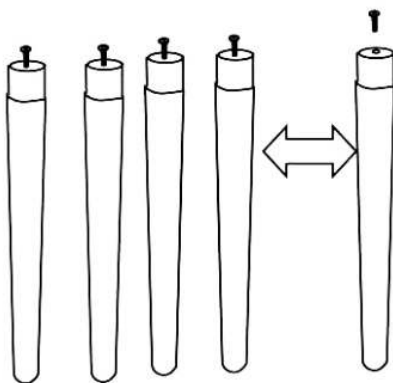
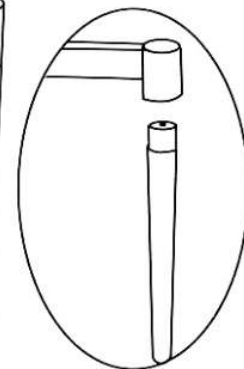
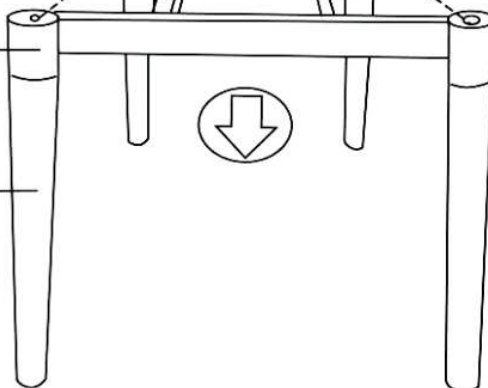
**C****B**

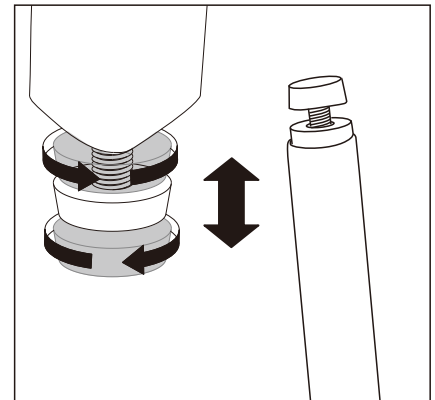
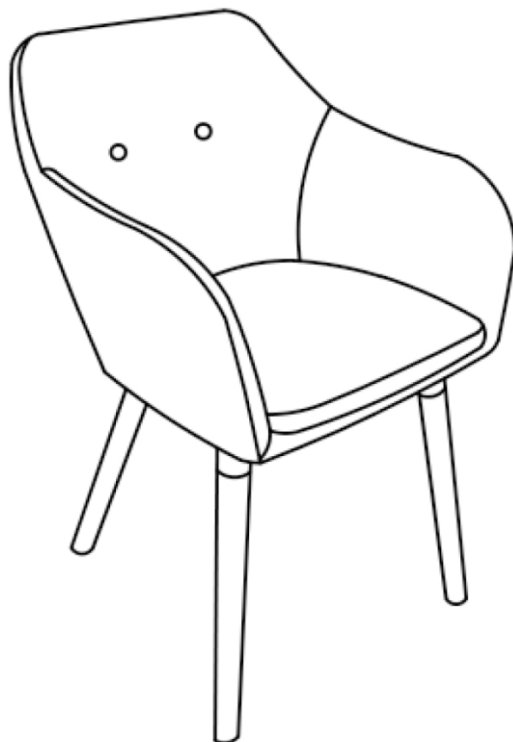
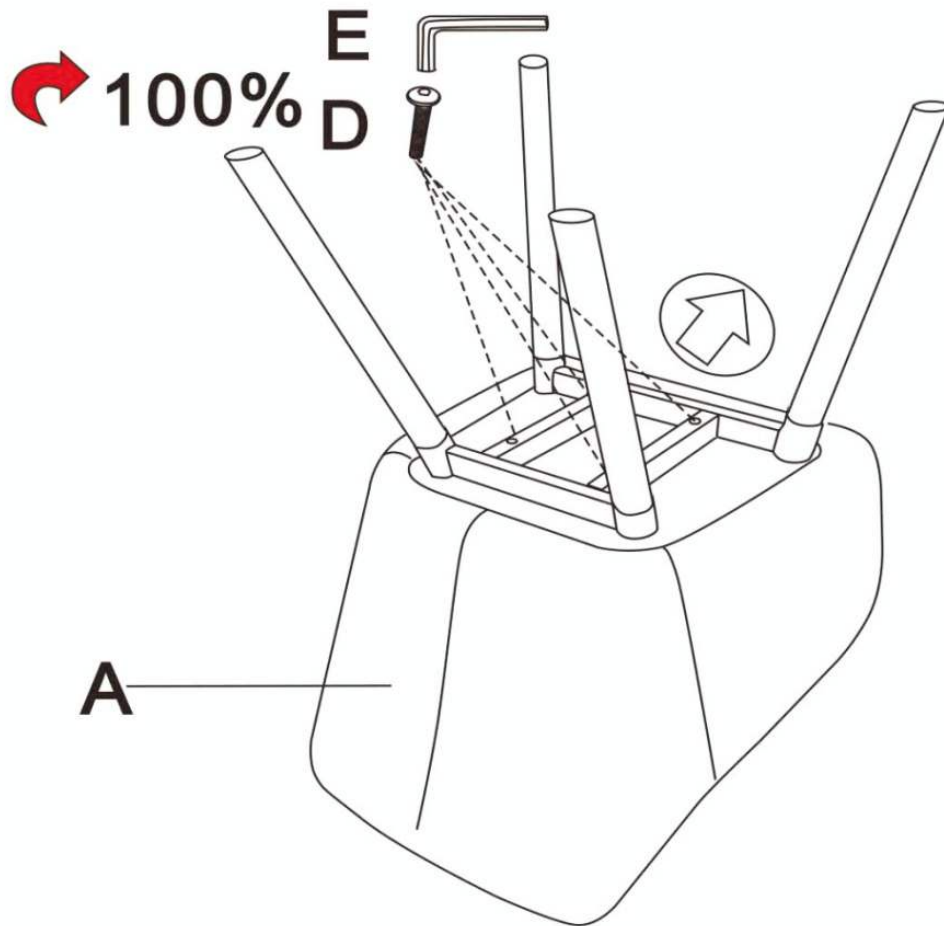

- EN** Check the chair , if any lopsided then could adjust the foot pin on the legs
FR Vérifier la chaise , si elle est de travers , il est possible d'ajuster l'axe des pieds.
ES Compruebe la silla , si hay alguna inclinada entonces podría ajustar el pasador de pie en las piernas
PT Verificar a cadeira , se estiver desequilibrada , pode ajustar o pino do pé nas pernas
DE Prüfen Sie den Stuhl , wenn er schief steht , können Sie den Fußstift an den Beinen einstellen.
IT Controllare la sedia , se è sbilenco si può regolare il perno del piede sulle gambe.

If you have any questions, please contact our customer care center, Our contact details are below:

US

 001-877-644-9366

 customerservice@aosom.com

Imported by Aosom LLC
27150 SW Kinsman Rd Wilsonville, OR 97070 USA
MADE IN CHINA

Wenn Sie Fragen haben, wenden Sie sich bitte an unser Kundendienstzentrum, Unsere Kontaktdaten stehen unten:

DE

 0049-0(40)-88307530

 service@aosom.de

ADRESSE DES IMPORTEURE/Hersteller/REP:
MH Handel GmbH
Wendenstraße 309
D-20537 Hamburg
Germany
IN CHINA HERGESTELLT

If you have any questions, please contact our customer care center, Our contact details are below:

CA

 416-792-6088

 customerservice@aosom.ca

Imported by Aosom Canada Inc.
7270 Woodbine Avenue, Unit 307, Markham,
Ontario Canada L3R 4B9
MADE IN CHINA

Si vous avez la moindre question, veuillez contacter notre centre d'assistance à la clientèle, Nos coordonnées sont les suivantes:

 416-792-6088

 customerservice@aosom.ca

Importé par Aosom Canada Inc.
7270 Woodbine Avenue, unité 307,
Markham, Ontario Canada L3R 4B9
FABRIQUÉ EN CHINE

In caso di dubbio, si prega di contattare il nostro centro assistenza clienti, I nostri dettagli di contatto sono di seguito:

IT

 0039-0249471447

 clienti@aosom.it

IMPORTATO DA/Produttore/REP:
AOSOM Italy srl
Centro Direzionale Milanofiori
Strada 1 Palazzo F1
20057 Assago (MI)
P.I.: 08567220960
FATTO IN CINA

Si tiene alguna pregunta, comuníquese con nuestro Centro de Atención al Cliente, Nuestros datos de contacto son los siguientes:

ES

 0034-931294512

 atencioncliente@aosom.es

IMPORTADOR/Fabricante/REP:
SPANISH AOSOM, S.L.
C/ROC GROS, N°15.08550, ELS HOSTALETES DE
BALENYÀ, SPAIN.
B66295775
HECHO EN CHINA

If you have any questions, please contact our customer care center, Our contact details are below:

UK

 0044-800-240-4004

 enquiries@mhstar.co.uk

IMPORTER ADDRESS:
MH STAR UK LTD
Unit 27, Perivale Park,
Horsenden lane South
Perivale, UB6 7RH
MADE IN CHINA

Se tiver alguma dúvida, por favor contacte o nosso Centro de Atendimento ao Cliente, Os nossos dados de contacto são os seguintes:

PT

 0034-931294512

 info@aosom.pt.

IMPORTADOR/Fabricante/REP:
SPANISH AOSOM, S.L.
C.ROC GROS N.15, 08550. ELS HOSTALETES DE
BALENYÀ
FEITO NA CHINA

Si vous avez la moindre question, veuillez contacter notre centre d'assistance à la clientèle, Nos coordonnées sont les suivantes:

FR

 0033-1-84166106

 aosom@mhfrance.fr

Importé par/Fabricant/REP:
MH FRANCE
2 Rue Maurice Hartmann
92130 Issy Les Moulineaux
France
FABRIQUÉ EN CHINE



FR

**DONNEZ
OU
RECYCLEZ**



ASSOCIATION

OU



LIVRAISON

OU



DÉCHÈTERIE

Adresses sur quefairedemesdechets.fr