



OWNER'S MANUAL

Please read entire manual before starting assembly.
Keep this manual along with your purchase receipt for future reference.

⚠ WARNING:
CHOKING HAZARD-Small parts.
Not for children under 18 Months.

⚠ WARNING:
Toy must be assembled by adult before use.

⚠ CAUTION
Screws contain potentially
hazardous sharp points or sharp
edges. Adult assembly required.

⚠ WARNING
To reduce the risk of injury, adult
supervision is required. Never use on road
ways, near motor vehicles, on or near steep
inclines or steps, swimming pools or other
bodies of water. Always wear shoes, and
never allow more than one rider.

Contents, colors and decorations may vary from those shown.

IMPORTANT, RETAIN FOR FUTURE REFERENCE: READ CAREFULLY

ASSEMBLY INSTRUCTION

Specifications:	
Battery:	6V/4.5AH*1
Motor:	6V 390# 25W*2
Suitable ages:	18+ months
Maximum weight:	25kg
Speed :	1.5-3km/h
Power way:	Charging type
Use of time:	Charg: 8-12 hours ; Use: 0.75 hours
Charger:	Input AC 100-240V, 50/60Hz, output DC 6V 500 mA

WARNING

1. The pictures in this instruction is only for explaining the operation and structure of the product, when there's any difference with the real product, please confirm with the real product.
2. In order to improve the quality of the product, we may amend some structure or appearance of the product without notification. Thank you for your understanding.

FOR THE SAFETY OF YOUR CHILD, PLEASE READ ALL WARNINGS AND ASSEMBLY/USE INSTRUCTIONS. KEEP THIS GUIDE FOR FUTURE REFERENCE.

- ADULT ASSEMBLY REQUIRED. The product contains small parts, which are for adult assembly only. keep small children away when assembling.
- Always remove protective material and poly bags and dispose before assembly.
- Never leave child unattended. direct adult supervision is required.
- Always keep child in view when child is in vehicle.
- Keep Children within Safe Riding Areas:
 - Never use in roadways, near motor vehicles, on lawn space, on or near steep inclines or steps, swimming pools or any other dangerous area.
- Use the toy only on flat surfaces. Such as inside your house, garden or playground.
- Never use in the dark. A child could encounter unexpected obstacles and have an accident. Operate the vehicle only in the daytime or a well-lit area.
- Please avoid running on sand or any other rough ground.
- Always wear shoes.
- Always sit on the seat.
- This toy has no brake.
- It is prohibited to change the circuit or add other electric parts
- Inspect wires and connections of the vehicle periodically.
- Do not let any child touch the wheels or be near them when the car is moving.
- This vehicle has adjustable play seat belts. Please instruct children how to tie the safety belt before using, guarantee the security.

STORAGE BATTERY INFORMATION AND MAINTENANCE

- Please charge 8 to 12 hours before first time use.
- Please use the suitable adapter to charge storage battery, otherwise the ride-on will be damaged.
- Please charge the car once the speed is slower than normal, otherwise it will decrease storage battery life.
- Please fully charge the battery before you put your ride-on away, and remember to recharge the battery every 30 days. This will ensure the normal use of the battery, otherwise, the battery might not hold a charge without proper maintenance.
- Batteries may leak fluids that can cause chemical burn injury or ruin your product.
- To avoid battery leakage: Do not mix old and new batteries or batteries of different types: alkaline, standard (carbon-zinc) or rechargeable (nickel-cadmium).
- Insert batteries as indicated inside the battery compartment. Remove batteries during long periods of non-use.
- Always remove exhausted batteries from the product. Dispose of batteries safely. Do not dispose of batteries in a fire. The batteries may explode or leak.
- Never short-circuit the battery terminals.
- Non-rechargeable batteries are not to be recharged.
- Use only batteries of the same or equivalent type as recommended.
- Do not charge non-rechargeable batteries.
- Remove rechargeable batteries from the product before charging.
- If removable rechargeable batteries are used, they are only to be charged under adult supervision
- Every single charging can not go over 24 hours. Both charger and storage batteries will occur mildly warm during charging. Do not use mal-functioned adapter or storage battery unless they are repaired.
- Charger and storage batteries are not considered as toys.
- Please make periodical inspection for storage battery, especially for adapter wires and plugs.
- Please turn off the switch when the ride-on is not in use. Please do a full charge after long periods of inactivity.
- Charge in well ventilated, dry place. Do not open the battery or the charger.
- Tighten the screws with a screwdriver. DO NOT over tighten

Disposal Of Battery:

1. Your sealed lead-acid battery must be recycled or disposed of in an environmentally sound manner.
2. Do not dispose of your lead-acid battery in a fire. The battery may explode or leak.
3. Do not dispose of a lead-acid battery in your regular, household trash. The incineration, land filling or mixing of sealed lead-acid batteries with house-hold trash is prohibited by law.

PREVENT FIRE AND ELECTRIC SHOCK:

- Use the only rechargeable battery and charger supplied with your vehicle.
- NEVER substitute the battery or the charger with another brand. Using another battery or charger may cause a fire or explosion.
- Do not use the battery or charger for any other product. Overheating, fire or explosion could occur.
- NEVER modify the electric circuit system. Tampering with the electric system may cause a shock, fire or explosion or may permanently damage the system.
- Do not allow direct contact between battery terminals. Fire or explosion can occur.
- Do not allow any type of liquid on the battery or its components.
- Explosive gasses are created during charging. Do not charge near heat or flammable materials. Charge the battery in a well-ventilated area ONLY.
- NEVER pick up the battery by the wires or charger. Damage can occur to the battery and may cause a fire. Pick up the battery by the case ONLY.
- Charge the battery in a dry area ONLY.
- Battery posts, terminals and related accessories contain lead and lead compounds, chemicals known to the State of California to cause cancer and reproductive harm. Wash hands after handling.
- Do not open the battery. Battery contains lead acid and other materials that are toxic and corrosive.
- Do not open the charger. Exposed wiring and circuitry inside case may cause electric shock.
- ONLY adults may handle or charge the battery. NEVER allow child to handle or charge the battery. Battery is heavy and contains lead acid (electrolyte).
- Do not drop the battery. Permanent damage to the battery could occur or cause serious injury.
- Before charging the battery, check for wear or damage to the battery, charger, its supply cord and the connectors. DO NOT charge the battery if any damage to parts has occurred.
- Do not allow the battery to drain completely. Recharge the battery after each use or once a month if not used regularly.
- Do not charge battery upside down.
- Always secure the battery with the bracket. Battery can fall out and injure a child if vehicle tips over.
- It is parents' responsibility to check main parts of the toy before using. Must regularly examine for potential hazard, such as the battery, charge, cable or cord, plug, screws are fastening enclosure of other parts and that in the event of such damage, the toy must not be until that damage had been properly removed. Make sure the plastic parts of the vehicle are not cracked or broken.
- Occasionally use a lightweight oil to lubricate moving parts such as wheels.
- Park the vehicle indoors or cover it with a tarp to protect it from wet weather.
- Keep the vehicle away from sources of heat, such as stoves and heaters. Plastic parts may melt.
- Recharge the battery after each use. Only an adult can handle the battery. Recharge the battery at least once a month when the vehicle Raider is not being used.
- Do not wash the vehicle with a hose. Do not wash the vehicle with soap and water. Do not drive the vehicle in rainy or snowy weather. Water will damage the motor, electric system and battery.
- Clean the vehicle with a soft, dry cloth. To restore shine to plastic parts, use a non-wax furniture polish. Do not use car wax. Do not use abrasive cleaners.
- Do not drive the vehicle in loose dirt, sand or fine gravel which could damage moving parts, motors or the electric system.
- When not using, all the electrical source should be turn off. Turn off the power switch and disconnect the battery connection.

Charge the Battery



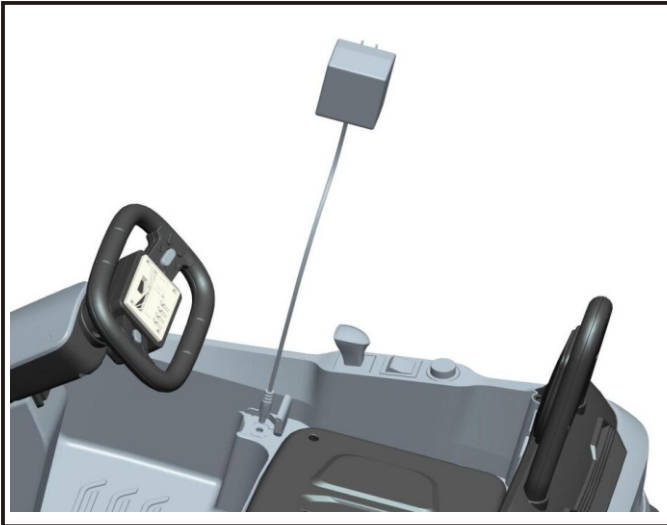



The first charge will take about 12 hours.



Charge the battery directly from the socket near the seat.

- Plug the battery connector into the charger port.
- Plug the charger into a standard wall outlet. The charger may feel warm during charging.
- Only use the 6 volt charger to charge your 6 volt battery.
- Note: if power flow to the wall outlet is controlled by a switch, make sure the switch is "ON"
- Before first-time use, charge the battery for at least 12 hours. Never charge the battery longer than 24 hours.
- Recharge the battery for at least 8-10 hours after each use of your vehicle.
- Do not charge or store battery upside down. Charging produces explosive gases. Charge away from flames, sparks and lit cigarettes. Charge in a well ventilated area.
- Once the battery is charged, disconnect the battery connector from the charger connector. Unplug the charger from the wall outlet. The battery is now ready to be installed in your vehicle. Please see the following Battery installation Section for detailed instructions on installing your vehicle:

- Please identify all parts before assembly and save all packaging material until assembly is completed to ensure that no parts are discarded.
- Metal parts have been coated with lubricant for protection during shipment. Wipe all metal parts with a paper towel to remove any excess lubricant.

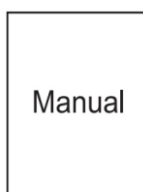
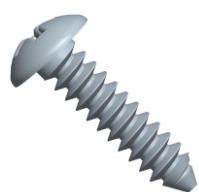
 <p>A x 1</p> <p>Main body</p>	 <p>B x 1</p> <p>Front component</p>	 <p>C x 1</p> <p>Charger</p>
 <p>D x 1</p> <p>Seat</p>	 <p>E x 1</p> <p>Lazyback</p>	 <p>F x 1</p> <p>Rear window</p>
 <p>G x 1</p> <p>Manual</p>	 <p>H x 7</p> <p>Screw (4x16mm)</p>	

Assembly

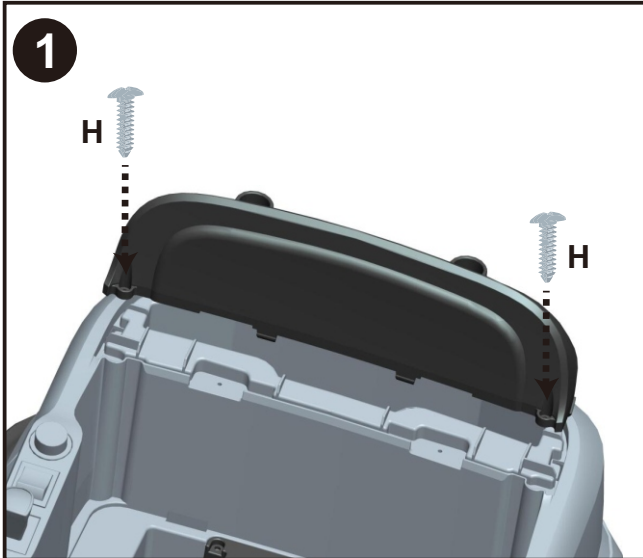

Rear window Assembly:

Place the rear window to the right place and fasten it with two screws(4 x 16mm) as picture shown.



Lazyback Assembly:

Insert the lazyback to the rear window as picture shown.

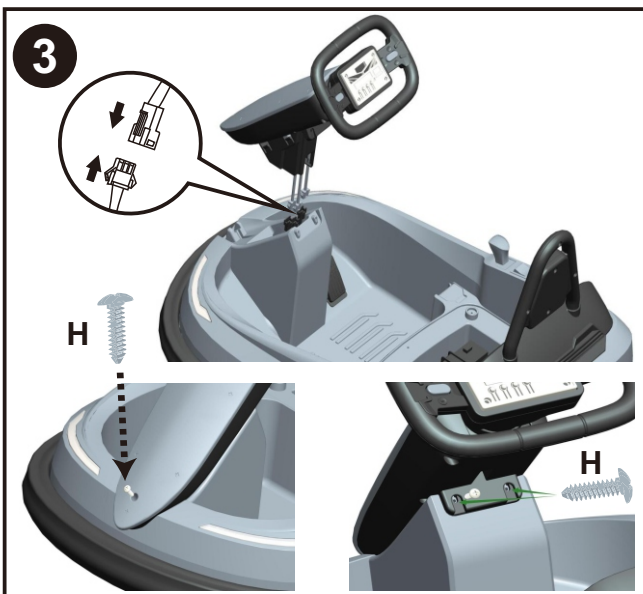

Front components Assembly:

Plug connectors and put the front component to the right place in front of the body, and fasten it with three screws(4 x 16mm) as picture shown.

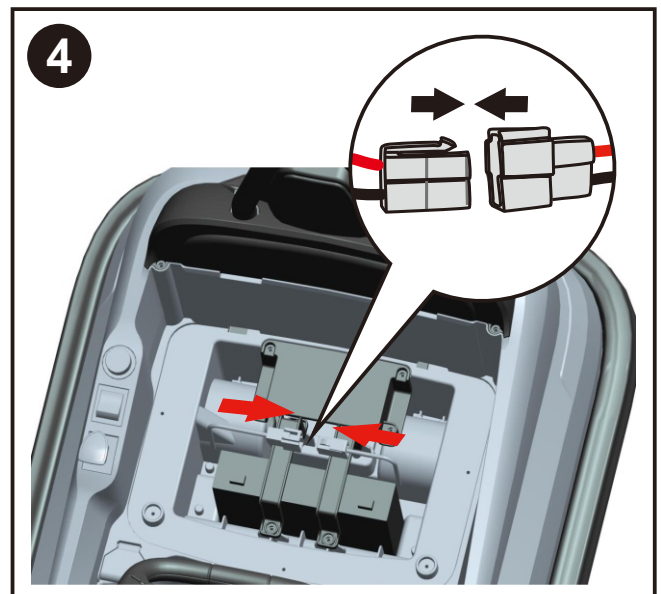

Battery connection:

Open the seat and you can see the power cable. Plug connectors as the picture shown.

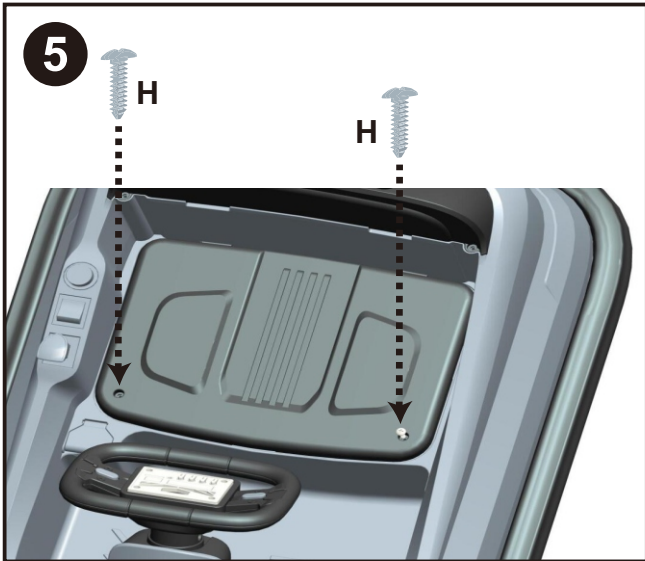

“Snap” the seat into the right place and fasten it with two screws(4 x 16mm) as picture shown.

Operating your vehicle

Power switch

Switch button ON and OFF.

Forward

Push the shifter in upward position and press the accelerator slowly.

Reverse

Push the shifter in downward position and press the accelerator slowly.

Low speed

Vehicle has been pre-set to operate at low speed (1.5 km/h) maximum. Once your child has mastered safe driving skills and understands the Safe Driving Rules.

High speed

vehicle to be driven at the higher speed (3.5 km/h) maximum.

Make sure your child can safely steer and operate the vehicle and knows the rules for safe driving.

Stop

Vehicle will automatically stop after the accelerator is released.

Sound effect

Press the button on the steering wheel

Safety device

AUTO POWER OFF. If the motor is overloaded for any reason, including improper usage, an electrical circuit breaker will automatically cut off the power, then resume after the parts have cooled!

Maintenance

Clean with a dry, soft cloth only. Do not wash with water or corrosive agents.

Store vehicle in a dry area when not in use, since moisture could cause the metal components and electrical parts to corrode. Remember to charge the battery monthly while the vehicle is not in regular use.

Check and tighten all screws and coverings regularly.

Check all plastic parts for cracks. Replace as necessary.



Troubleshooting

Problem	Possible Cause	Solution
car does not move	Circuit breaker tripped	Circuit breaker may "trip" and stop the vehicle if it is overloaded or the driving conditions too severe. The breaker will automatically reset after approximately 10 seconds, and the vehicle will operate normally. To avoid repeated automatic shut downs, do not overload the vehicle by exceeding the weight limited of 25kg (55 lbs). Or by towing anything behind the vehicle. Do not drive up hills or run into fixed objects, which can cause the wheels to stop spinning while power is still being supplied to the motors.
	Loose wire or connectors	Check all wires and connectors Make sure that the motor harness connector is plugged in tightly to the battery, and that there are no loose wires around the motor.
	Dead battery	An old or improperly cared battery may be dead. If you are unsure whether it is dead or not, you can have it tested at your Service Center.
	Undercharged battery	A new battery should have been charged for at least 12 hours before using the vehicle for the first time. After that, it must be recharge the battery for at least 8-10 hours after each use. Never charge longer than 24 hours. Check all connectors; make sure the charger is plugged into the wall. Make sure the power flow to the outlet is on.
	Charger is not working	You must have a volt meter in order to tell whether the charger is working or not. If you think there maybe a problem with the charger, take it to the Service Center where they will test it for you.
	Damaged switch	When exposed to water or moisture, switches can become corroded, or can jam due to loose dirt, sand or gravel. Contact your Service Center for diagnosis and repair.

Problem	Possible Cause	Solution
Car was running but suddenly stopped	Loose wire or connectors	Check all wires and connectors. Make sure that the motor harness connector is plugged into the battery tightly, and that there are no loose wires around the motor.
	Circuit breaker tripped	Circuit breaker may "trip" and stop the vehicle if it is overloaded or the driving conditions too severe. The breaker will automatically reset after approximately 10 seconds, and the vehicle will operate normally. To avoid repeated automatic shutdowns, do not overload the vehicle by exceeding the weight limited of 25kg (55 lbs), or by towing anything behind the vehicle. Do not drive up hills or run into fixed object, which can cause the wheels to stop spinning while power is still being supplied to the motors. If breaker continually trips, contact your Service Center.
Short operating time (less than 1 hours per charge)	Undercharged battery	A new battery should have been charged for at least 12hours before using the vehicle for the first time. After that, it must be recharge the battery for at least 8-10 hours after each use.
	Overcharged battery	Never charge longer than 24 hours. Check all connectors; make sure the charger is plugged into the wall. Make sure the power flow to the outlet is on. Never charge battery longer than 24 hours. If you think the battery maybe damage due to overcharging, contact Service Center for testing.
	Old battery will not accept a full charge	Even with proper care, a rechargeable battery does not last forever. Average battery life is 1 to 3 years depending on vehicle use and use conditions. Replace the battery with a new rechargeable battery. Do not substitute parts. To get a replacement battery, please contact Service Center.

Problem	Possible Cause	Solution
Vehicle is sluggish	Undercharged battery	A new battery should have been charged for at least 12 hours before using the vehicle for the first time. After that, it must be recharge the battery for at least 8-10 hours after each use. Never charge longer than 24 hours. Check all connectors; make sure the charger is plugged into the wall. Make sure the power flow to the outlet is on.
	Battery needs charging	Be sure to charge the battery after each use.
	Old battery will not accept a full charge	Even with proper care, a rechargeable battery does not last forever. Average battery life is 1 to 3 years depending on vehicle use and use conditions. Replace the battery with a new rechargeable battery. Do not substitute parts. To get a replacement battery, please contact Service Center.
	Vehicle is overloaded	Allow no more than 1 rider at a time, follow the 25kg (55lbs) weight capacity and don't tow anything behind the vehicle.
	Driving conditions are too stressful	Use only on a generally level ground.
Intermittent vehicle operation	Loose wire or connector	Check all wires around the motors and all connectors to make sure they are tight.
	Motor or electrical switch damage	Contact your Service Center for diagnosis and repair.
When the accelerator is pressed, the vehicle won't run without a push	Loose wire or connector	Check all wires around the motors and all connectors to make sure they are tight.
	"Dead Spot on motor	Contact your Service Center for diagnosis and repair.
Motor gear box makes a loud grinding or clacking noise	Broken gears	Contact your Service Center for diagnosis and repair.
Charger get warm during use	This is normal and should not be concern	No action required.
Battery makes gurgling or sizzling noise while charging	Some noise and swelling is normal and should not be a concern	No action required. If the battery does not make noise while charging. It does not mean it is not accepting the charging.

Parts diagram

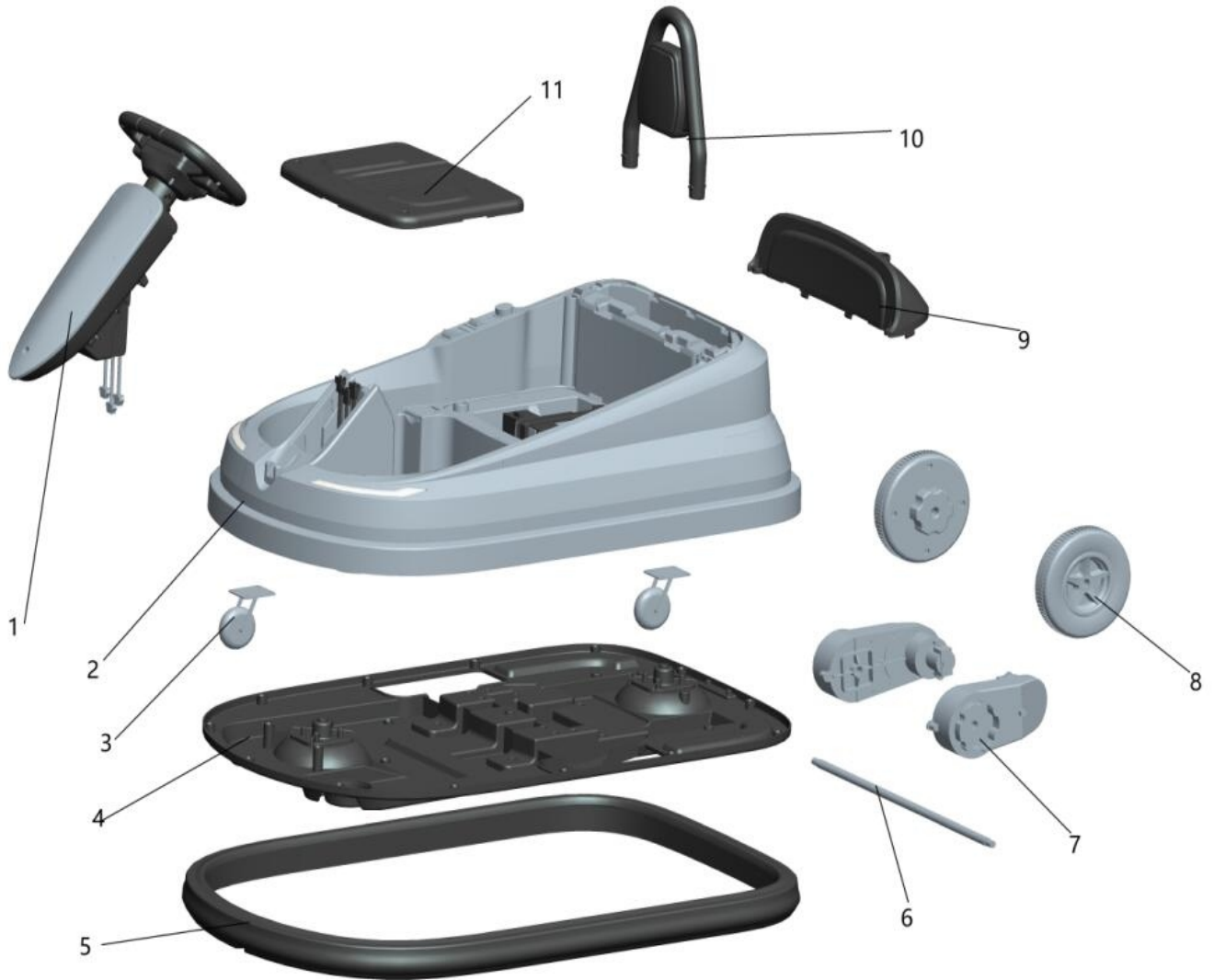

Note: Some parts shown are assembled to both sides of the vehicle.

No. Part	Quantity	No. Part	Quantity
1. Front components	1	9. Rear Window	1
2. Main Body	1	10. Lazyback	1
3. Omni-directional wheel	2	11. Seat	1
4. Bottom fender	1		
5. Bumper bar	1		
6. Rear Axle	1		
7. Gear Box	2		
8. Rear Wheel	2		

Model identify	370-282V70	
Input voltage	AC 100-240	V
Input AC frequency	50/60	Hz
Output voltage	DC 6	V
Output current	0.5	A
Output power		W
Average active efficiency	79.2	%
Efficiency at low load (10 %)	61.4	%
No-load power consumption	0.07	W

UK

If you have any questions, please contact our customer care center.
Our contact details are below:



0044-800-240-4004



enquiries@mhstar.co.uk

IMPORTER ADDRESS:
MH STAR UK LTD
Unit 27, Perivale Park,
Horsenden lane South
Perivale, UB6 7RH
MADE IN CHINA

