

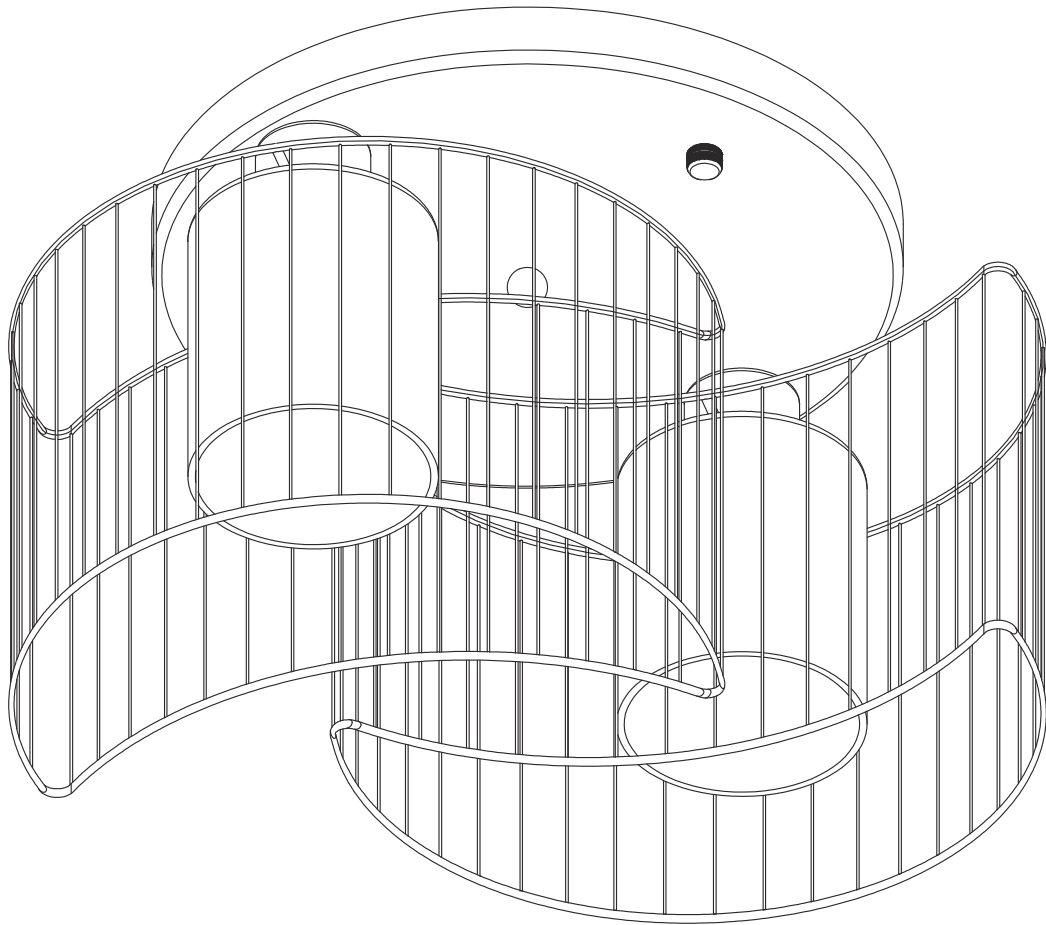

IN230700017V01_UK_FR_ES_PT_DE_IT

B31-003_B31-003V01_B31-004



EN_ IMPORTANT, RETAIN FOR FUTURE REFERENCE: READ CAREFULLY.

FR_ IMPORTANT: A LIRE ATTENTIVEMENT ET A CONSERVER POUR VOUS Y REFRERER ULTERIEUREMENT.

ES_ IMPORTANTE, LEA DETENIDAMENTE Y GUARDE PARA FUTURAS REFERENCIAS.

PT_ IMPORTANTE, GUARDE PARA FUTURA REFERÊNCIA, LEIA ATENTAMENTE.

DE_ „WICHTIG! SORGFÄLTIG LESEN UND FÜR SPÄTER NACHSCHLAGEN AUFBEWAHREN.“

IT_ IMPORTANTE, LEGGERE E CONSERVARE QUESTO MANUALE D'ISTRUZIONE PER UN USO FUTURO.

EN

Dear customer,

Thank you for purchasing this product. So that your appliance serves you well, please read all the instructions in this user's manual. If you have any questions, please contact our customer care center.

FR

Cher client,

Nous vous remercions d'avoir acheté ce produit. Afin que vous puissiez profiter pleinement de votre appareil, veuillez lire toutes les instructions de ce manuel d'utilisation. Si vous avez la moindre question, veuillez contacter notre centre d'assistance à la clientèle.

DE

Sehr geehrter Kunde,

Vielen Dank, dass Sie dieses Produkt erworben haben. Damit Ihr Gerät Ihnen gute Dienste leistet, lesen Sie bitte alle Hinweise in diesem Benutzerhandbuch. Wenn Sie Fragen haben, wenden Sie sich bitte an unser Kundendienstzentrum.

ES

Queridos clientes,

Gracias por comprar este producto. Para que su electrodoméstico le sirva mejor, lea todas las instrucciones de este manual del usuario. Si tiene alguna pregunta, comuníquese con nuestro Centro de Atención al Cliente.

PT

Caros clientes,

Obrigado por adquirir este produto. Para que o seu aparelho o sirva melhor, leia todas as instruções deste manual do utilizador. Se tiver alguma dúvida, por favor contacte o nosso Centro de Atendimento ao Cliente.

IT

Caro Cliente,

Grazie per aver acquistato questo prodotto. Per servirti meglio con questo apparecchio ti prego di leggere tutte le istruzioni in presente manuale utente. In caso di dubbio, si prega di contattare il nostro centro assistenza clienti.

EN_Our contact details are below:



FR_Nos coordonnées sont les suivantes:

DE_Unsere Kontaktdaten stehen unten:

ES_Nuestros datos de contacto son los siguientes:

PT_Os nossos dados de contacto são os seguintes:

IT_I nostri dettagli di contatto sono di seguito:

Country	 Phone	 Email
UK	0044-800-240-4004	enquiries@mhstar.co.uk
DE	0049-0(40)-88307530	service@aosom.de
FR	0033-1-84166106	aosom@mhfrance.fr
ES	0034-931294512	atencioncliente@aosom.es
PT	0034-931294512	info@aosom.pt.
IT	0039-0249471447	clienti@aosom.it

Specification

Model	B31-003_B31-003V01_B31-004
Max power	40W
Adapter input	AC 220-240V ~ 50Hz

IMPORTANT SAFETY INSTRUCTIONS:

1. Use an authorized and certified electrician for consultation and installation.
2. The ceiling must have at least the capacity of 5 times of the weight of the ceiling light.

Warnings:

1. Turn off electricity supply at main circuit panel before installing.
DO NOT connect electricity supply until your ceiling light is fully assembled and installed. Manufacturer and distributor accept NO liability for incorrect installation.
2. To reduce the risk of fire, electrical shock or personal injury, always turn off the ceiling light
3. Deviation from instructions may result in a risk of fire or electric shock.

CARE INSTRUCTIONS:

1. Make sure the power supply is turned off before handling.
2. Wipe clean with a dry cloth / mild soapy solution. Do not use corrosive cleaners.
3. The cable cord of this chandelier light cannot be replaced. If the cable is damaged, do not use the light.
4. Indoor use only.
5. To avoid the risk of fire, do not exceed the recommended wattage.
6. Keep away from children.

*** Do not discard any contents until after assembly is complete to avoid accidentally discarding small parts or hardware.**

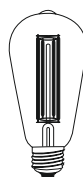

LED
E27 (medium) base
(Not included)

**DO NOT EXCEED THE
SPECIFIED WATTAGE.**

Spécification

Modèle	B31-003_B31-003V01_B31-004
Puissance Max	40W
Entrée Adaptateur	AC 220-240V ~ 50Hz

INSTRUCTIONS DE SÉCURITÉ IMPORTANTES:

1. Un électricien autorisé et agréé est requis pour consultation et installation.
2. Le plafond doit avoir au moins la capacité de 5 fois le poids du plafonnier.

Avertissements:

1. Débranchez l'alimentation au panneau principal avant l'installation. Ne connectez pas l'alimentation jusqu'à ce que votre plafonnier soit entièrement assemblée et installée. Le fabricant et le distributeur n'acceptent aucune responsabilité pour une installation incorrecte.
2. Pour réduire le risque d'incendie, de choc électrique ou de blessures corporelles, éteignez toujours le plafonnier et laissez- la refroidir avant de remplacer l'ampoule. Ne touchez pas l'ampoule lorsque l'appareil est allumé ou regarder directement l'ampoule. Gardez les matériaux inflammables à l'écart de l'ampoule.
3. L'inobservation des instructions peut entraîner un risque d'incendie ou de choc électrique.

INSTRUCTIONS D'ENTRETIEN:

1. Veiller à ce que la puissance est coupée et que l'ampoule est refroidie avant la manipulation.
2. Essuyez avec un chiffon sec / solution savonneuse douce. N'utilisez pas de nettoyeurs corrosifs.
3. Le câble du plafonnier ne peut pas être remplacé : si le câble est endommagé, n'utilisez pas la lumière.
4. Pour usage intérieur seulement.
5. Ne dépassez pas la puissance recommandée pour éviter le risque d'incendie.
6. Gardez-le hors de la portée des enfants.

*** Ne jetez pas le contenu avant d'avoir terminé l'assemblage afin d'éviter de jeter accidentellement de petites pièces ou des accessoires matériels.**

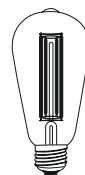

DÉL
Base E27 (moyenne)
(Non inclus)

**NE PAS DÉPASSER LA
PUISSANCE INDIQUÉE.**

Spezifikationen

Modell	B31-003_B31-003V01_B31-004
Max. Leistung	40W
Adaptereingang	AC 220-240V ~ 50Hz

WICHTIGE SICHERHEITSANWEISUNGEN:

1. Wenden Sie sich zur Beratung und Installation an einen autorisierten und zertifizierten Elektriker.
2. Die Kapazität der Decke muss mindestens das 5-fache des Gewichts der Deckenleuchte betragen.

Warnungen:

1. Schalten Sie die Stromversorgung an der Hauptschalttafel vor der Installation aus. Schließen Sie die Stromversorgung erst an, wenn Ihre Deckenleuchte vollständig montiert ist. Der Hersteller und Händler übernimmt keine Haftung für fehlerhafte Installation.
2. Um die Gefahr von Feuer, Stromschlag oder Verletzungen zu verringern, schalten Sie bitte die Deckenleuchte immer aus und lassen Sie sie abkühlen, bevor Sie die Glühbirne wechseln. Berühren Sie die Glühbirne nicht, wenn das Gerät eingeschaltet ist, und schauen Sie nicht direkt auf die Glühbirne. Halten Sie brennbare Materialien von der Glühbirne fern.
3. Die Nichtbeachtung der Anweisungen können zu Brandgefahr oder Stromschlag führen.

WARNUNGSHINWEISE:

1. Stellen Sie vor der Handhabung sicher, dass die Stromversorgung ausgeschaltet und die Glühbirne abgekühlt ist.
2. Wischen Sie mit einem trockenen Tuch / einer milden Seifenlösung ab. Verwenden Sie keine ätzenden Reinigungsmittel.
3. Das Kabel dieser Deckenleuchte kann nicht ersetzt werden:
Wenn das Kabel beschädigt ist, verwenden Sie die Leuchte nicht.
4. Sie ist nur für den Innengebrauch bestimmt.
5. Überschreiten Sie nicht die empfohlene Leistung, um die Brandgefahr zu vermeiden.
6. Halten Sie sie von Kindern fern.

*** Entsorgen Sie jeglichen Inhalt erst nach Abschluss der Montage, um ein versehentliches Entsorgen von Kleinteilen oder Hardware zu vermeiden.**

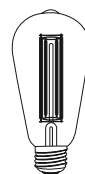

LED
E27 (mittlere) Basis
(Nicht mitgeliefert)

**ÜBERSCHREITEN SIE
DIE
VORGESCHRIEBENE
WATTZAHL NICHT.**

Especificaciones

Modelo	B31-003_B31-003V01_B31-004
Potencia máxima	40W
Adaptador de entrada	AC 220-240V ~ 50Hz

INSTRUCCIONES DE SEGURIDAD IMPORTANTES:

1. Consulte a un electricista autorizado y certificado sobre la instalación.
2. El techo debe tener al menos la capacidad de 5 veces del peso de la luz de techo.

Advertencias:

1. Apague el suministro eléctrico en el panel del circuito principal antes de realizar la instalación. NO conecte el suministro de electricidad hasta que la luz de techo esté ensamblada e instalada de forma completa.
El fabricante y el distribuidor NO asumen ninguna responsabilidad por instalación incorrecta.
2. Para reducir el riesgo de incendio, descarga eléctrica o lesiones personales, apague siempre la luz del techo.
3. El incumplimiento de las instrucciones puede provocar un riesgo de incendio o descarga eléctrica.

INSTRUCCIONES DE CUIDADO:

1. Asegúrese de que la fuente de alimentación esté apagada antes de manipularla.
2. Limpie la luz con un paño seco / solución jabonosa suave. No use limpiadores corrosivos.
3. El cable de esta lámpara no puede ser reemplazada. Si el cable está dañado, ya no puede usarla.
4. Solo para el uso en interiores.
5. Para evitar el riesgo de incendio, no exceda la potencia recomendada.
6. Mantenga la luz alejada de los niños.

*** No deseche ningún contenido hasta que se haya completado el montaje para evitar desechar accidentalmente piezas pequeñas o herrajes.**

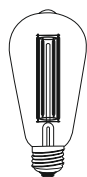

LED
Base de E27 (mediano)
(No incluido)

**NO EXCEDA LA
POTENCIA
ESPECIFICADA**

Especificações

Modelo	B31-003_B31-003V01_B31-004
Potência máxima	40W
Voltagem de entrada	AC 220-240V ~ 50Hz

INSTRUÇÕES DE SEGURANÇA IMPORTANTES

1. Consultar um electricista licenciado e certificado sobre a instalação.
2. O teto deve ter uma capacidade de pelo menos 5 vezes o peso do candeeiro de teto.

Advertência

1. Desligar a fonte de alimentação no painel do circuito principal antes da instalação.
NÃO ligar a fonte de alimentação até o candeeiro de teto estar completamente montado e instalado.
O fabricante e o distribuidor NÃO assumem qualquer responsabilidade por instalação incorreta.
2. Para reduzir o risco de incêndio, choque eléctrico ou ferimentos pessoais, desligue sempre o candeeiro de teto.
3. O não cumprimento das instruções pode resultar em risco de incêndio ou choque eléctrico.

INSTRUÇÕES DE MANUTENÇÃO:

1. Assegurar-se de que a fonte de alimentação está desligada antes de a manusear.
2. Limpar o candeeiro com um pano seco/solução de sabão suave. Não utilizar produtos de limpeza corrosivos.
3. O cabo deste candeeiro não pode ser substituído. Se o cordão estiver danificado, já não pode ser utilizado.
4. Apenas para utilização no interior.
5. Para evitar o risco de incêndio, não exceder a potência recomendada.
6. Manter o candeeiro afastado das crianças.

Não descartar qualquer conteúdo até que a montagem esteja concluída para evitar descartar acidentalmente pequenas peças ou ferragens.

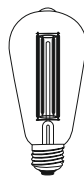

LED
Base E27 (média)
(Não incluída)

**NÃO EXCEDER A
POTÊNCIA
ESPECIFICADA.**

Specifiche

Modello	B31-003_B31-003V01_B31-004
Potenza massima	40W
Ingresso adattatore	AC 220-240V ~ 50Hz

IMPORTANTI ISTRUZIONI DI SICUREZZA:

1. Utilizzare un elettricista autorizzato e certificato per la consultazione e l'installazione.
2. Il soffitto deve avere almeno una capacità pari a 5 volte il peso della plafoniera.

Avvertenze:

1. Disattivare l'alimentazione elettrica sul pannello del circuito elettrico principale prima dell'installazione. Non collegare l'alimentazione elettrica finché la plafoniera non è completamente assemblata e installata. Il produttore e il distributore declinano ogni responsabilità per un'errata installazione.
2. Per ridurre il rischio di incendi, scosse elettriche o lesioni personali, spegnere sempre la plafoniera e lasciarla raffreddare prima di sostituire la lampadina. Non toccare la lampadina quando l'apparecchiatura è accesa o guardare direttamente la lampadina. Tenere i materiali infiammabili lontano dalla lampadina.
3. La deviazione dalle istruzioni può comportare il rischio di incendi o scosse elettriche.

ISTRUZIONI SULLA CURA:

1. Assicurarsi che l'alimentazione sia spenta e che la lampadina si sia raffreddata prima di maneggiarla.
2. Pulire con un panno asciutto / soluzione detergente delicata. Non utilizzare detergenti corrosivi.
3. Il cavo di questa plafoniera non può essere sostituito: se il cavo è danneggiato, non utilizzarla.
4. Solo per uso interno.
5. Per evitare il rischio di incendi, non superare la tensione elettrica consigliata.
6. Conservare lontano dalla portata dei bambini.

*** Non gettare qualsiasi contenuto fino a quando non è completato l'assemblaggio, per evitare di gettare accidentalmente piccole parti o accessori.**

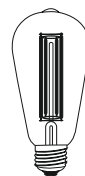

LED
E27 Base(media) (Non
in dotazione)

**NON SUPERARE LA
POTENZA
SPECIFICATA.**

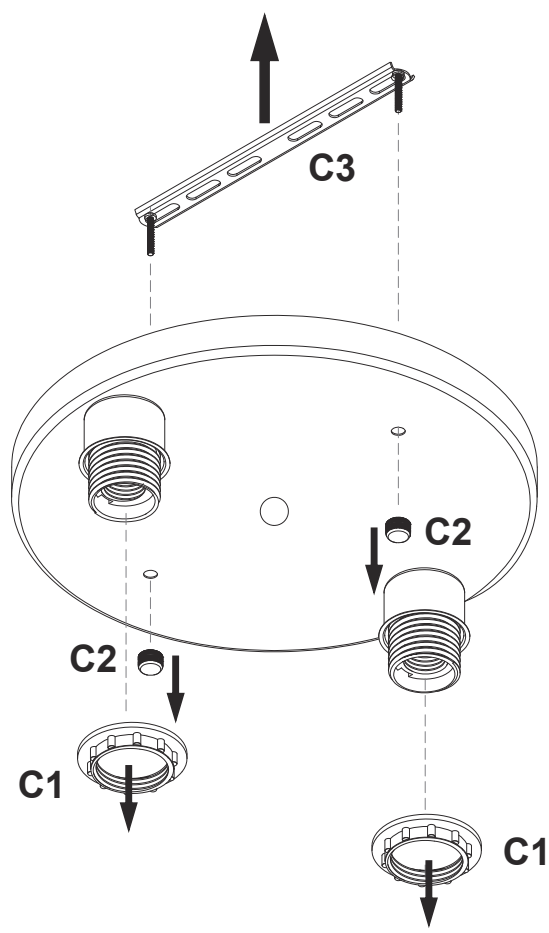
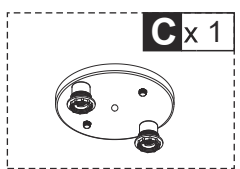
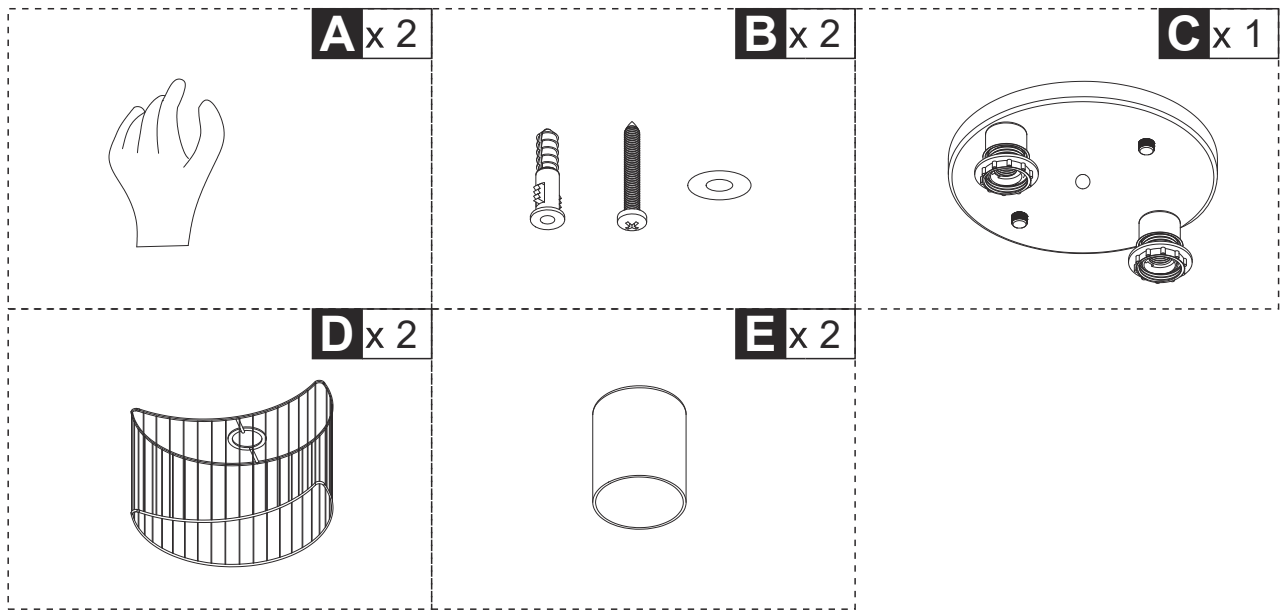

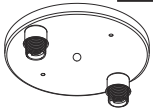
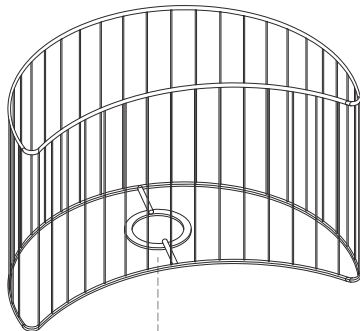
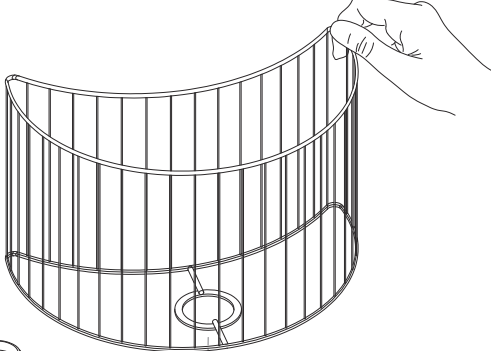
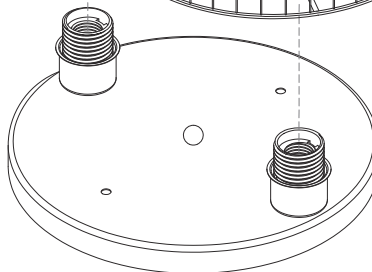
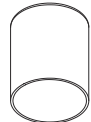
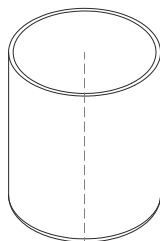
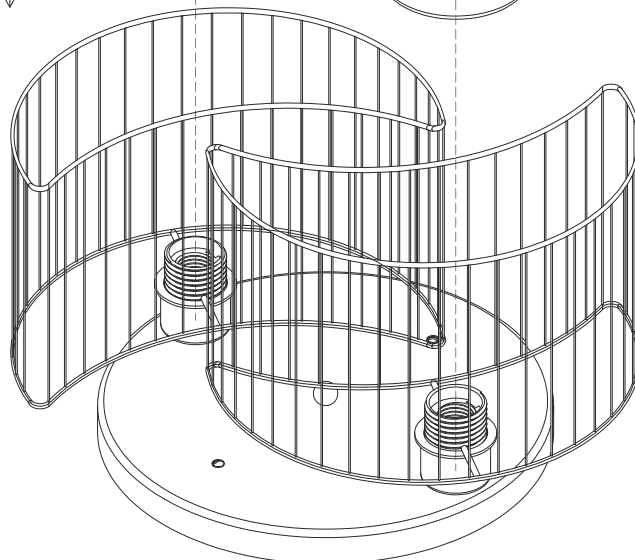
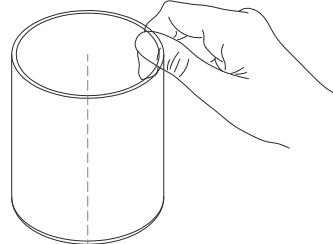
C x 1**D** x 2**D****D****C****E** x 2**E****E**

C1

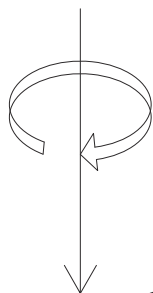

C1

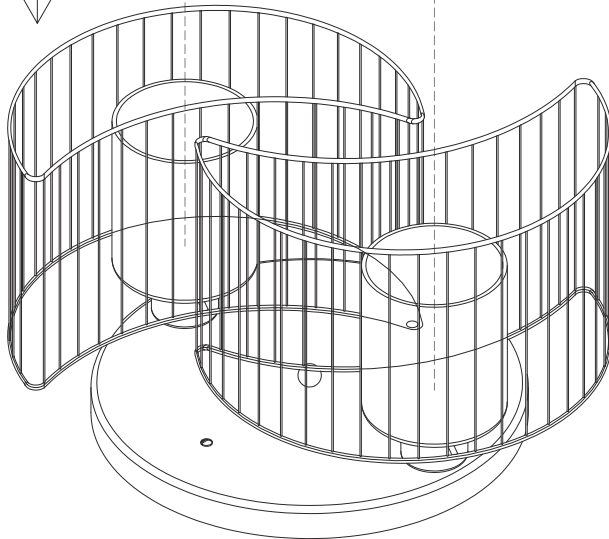
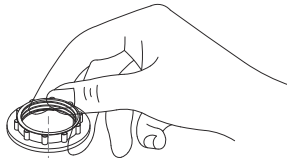

NOT INCLUDED

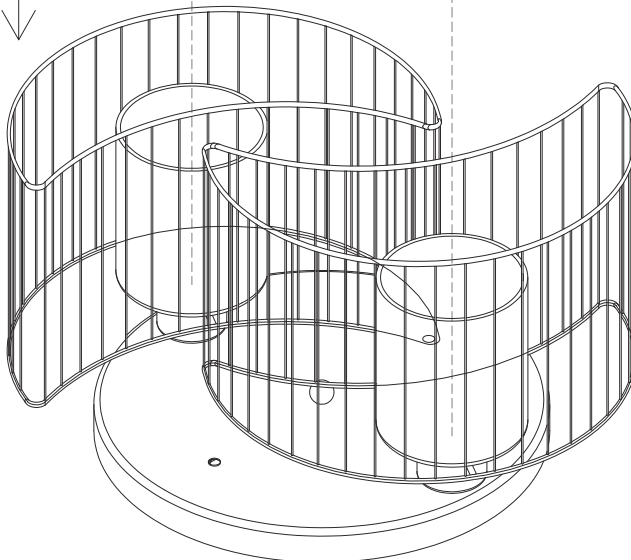
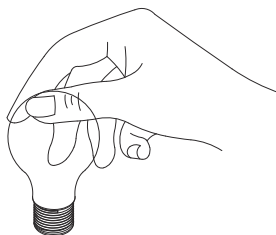
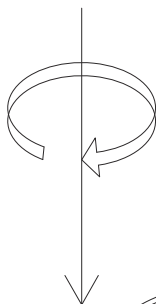

B x 2

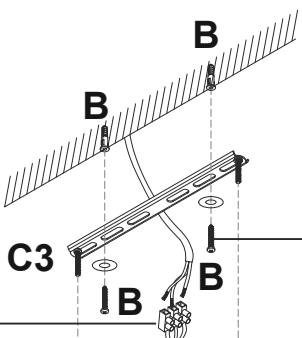
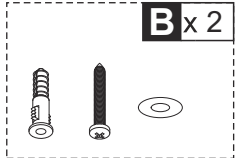

STEP 5-1

STEP 5-2

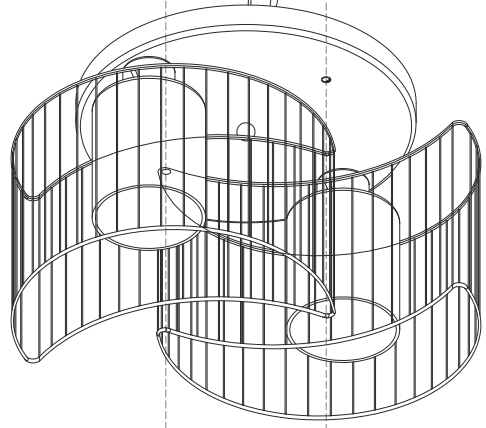
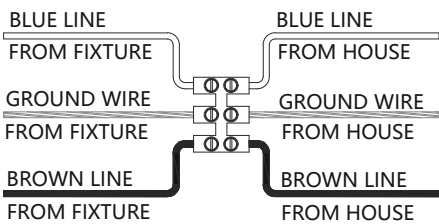
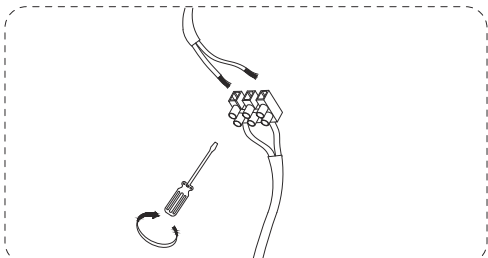

STEP 5-3

C2

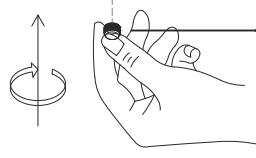

Done

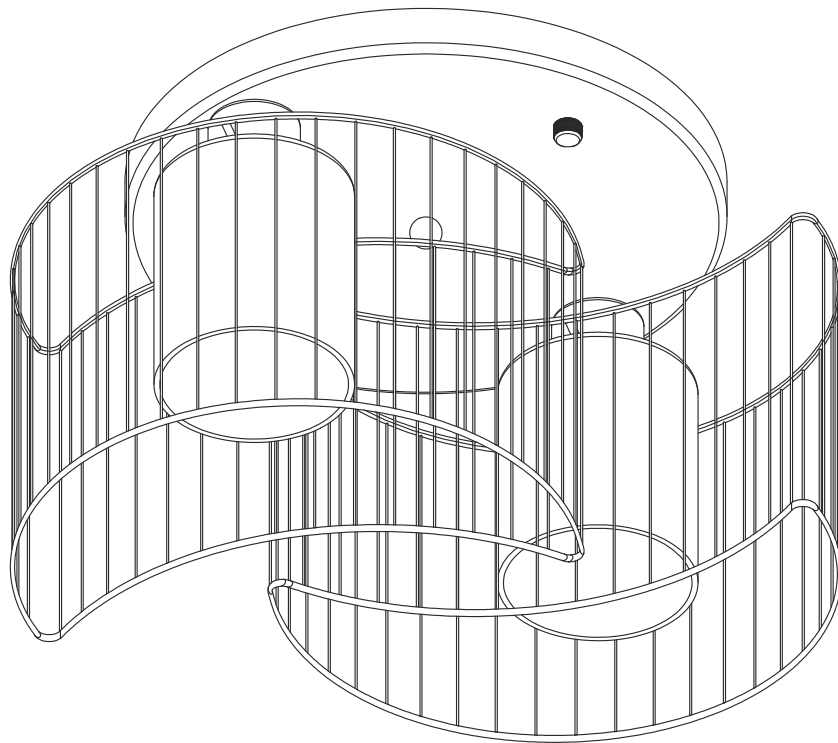

UK

If you have any questions, please contact our customer care center.

Our contact details are below:



0044-800-240-4004



enquiries@mhstar.co.uk

IMPORTER ADDRESS:

MH STAR UK LTD

Unit 27, Perivale Park,
Horsenden lane South

Perivale, UB6 7RH

MADE IN CHINA

ES

Si tiene alguna pregunta, comuníquese con nuestro Centro de Atención al Cliente. Nuestros datos de contacto son los siguientes:



0034-931294512



atencioncliente@aosom.es

IMPORTADOR:

SPANISH AOSOM, S.L.

C/ ROC GROS, N° 15. 08550, ELS HOSTALETS DE
BALENYÀ, SPAIN.

B66295775

WWW.AOSOM.ES

ATENCIONCLIENTE@AOSOM.ES

TEL: 931294512

HECHO EN CHINA

FR

Si vous avez la moindre question, veuillez contacter notre centre d'assistance à la clientèle.

Nos coordonnées sont les suivantes:



0033-1-84166106



aosom@mhfrance.fr

Importé par:

MH France

2, rue Maurice Hartmann

92130 Issy-les-Moulineaux

France

Fabriqué en Chine

PT

Se tiver alguma dúvida, por favor contacte o nosso Centro de Atendimento ao Cliente. Os nossos dados de contacto são os seguintes:



0034-931294512



info@aosom.pt.

IMPORTADOR:

SPANISH AOSOM, S.L

C.ROC GROS N.15, 08550. ELS HOSTALETS DE BALENYÀ

TEL: 931294512 (SEG-SEX DAS 7:30H ÀS 16:30H)

INFO@AOSOM.PT

WWW.AOSOM.PT

DE

Wenn Sie Fragen haben, wenden Sie sich bitte an unser Kundendienstzentrum.

Unsere Kontaktdaten stehen unten:



0049-0(40)-88307530



service@aosom.de

ADRESSE DES IMPORTEURE:

MH Handel GmbH

Wendenstraße 309

D-20537 Hamburg

Germany

IN CHINA HERGESTELLT

IT

In caso di dubbio, si prega di contattare il nostro centro assistenza clienti. I nostri dettagli di contatto sono di seguito:



0039-0249471447



clienti@aosom.it

IMPORTATO DA:

AOSOM Italy srl

Centro Direzionale Milanofiori

Strada 1 Palazzo F1

20057 Assago (MI)

P.I.: 08567220960

FATTO IN CINA