

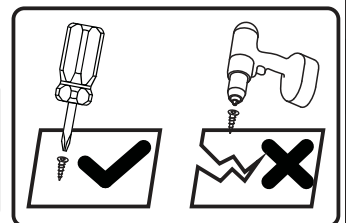

IN231000200V02\_GL

845-215\_845-215V01

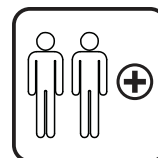
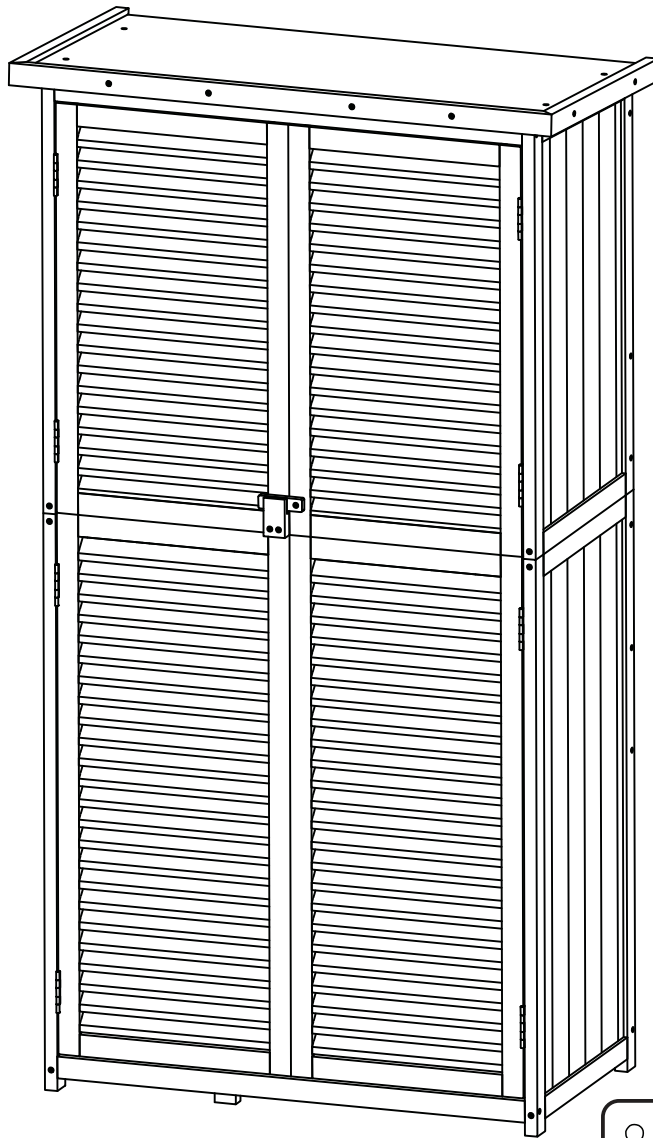

Tools Recommended

**EN\_ IMPORTANT, RETAIN FOR FUTURE REFERENCE: READ CAREFULLY.**

**FR\_ IMPORTANT: A LIRE ATTENTIVEMENT ET À CONSERVER POUR CONSULTATION ULTÉRIEURE.**

**ES\_ IMPORTANTE, LEA Y GUARDE PARA FUTURAS REFERENCIAS.**

**PT\_ IMPORTANTE, RETER PARA REFERÊNCIA FUTURA: LEIA ATENTAMENTE.**

**DE\_ WICHTIG! SORGFÄLTIG LESEN UND FÜR SPÄTER NACHSCHLAGEN AUFBEWAHREN.**

**IT\_ IMPORTANTE! CONSERVARE IL PRESENTE MANUALE PER FUTURO RIFERIMENTO E LEGGERLO ATTENTAMENTE.**

**A** x 1

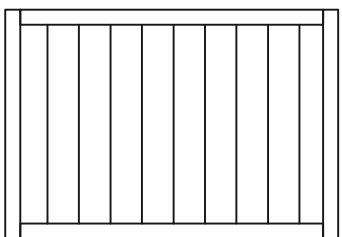

**B** x 1

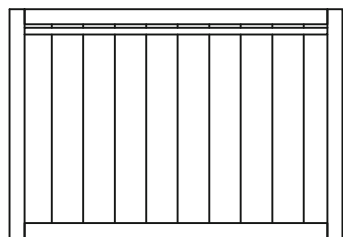

**C** x 1

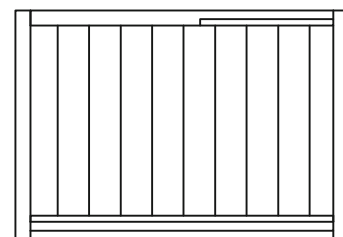

**D1** x 1

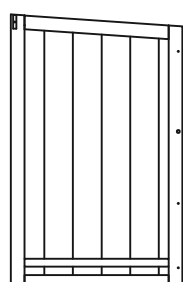

**D2** x 1

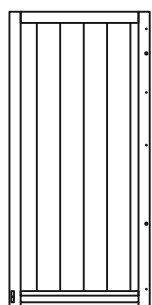

**E1** x 1

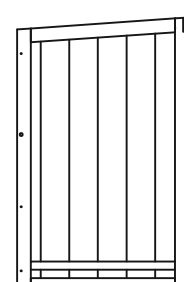

**E2** x 1

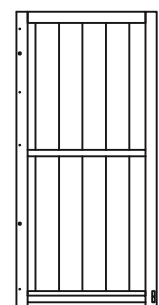

**F1** x 1

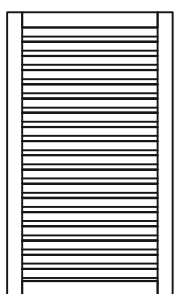

**F2** x 1

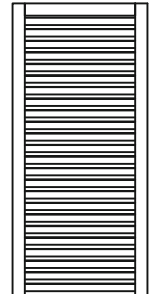

**G1** x 1

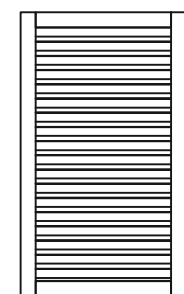

**G2** x 1

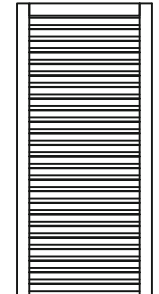

**H** x 1

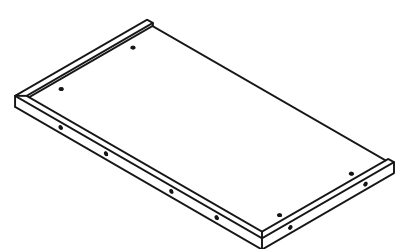

**I** x 1

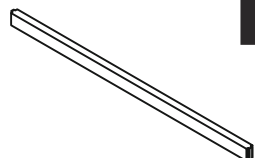

**K** x 1



**J** x 1

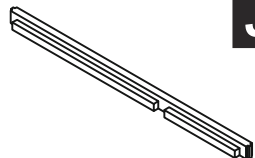

**L** x 1

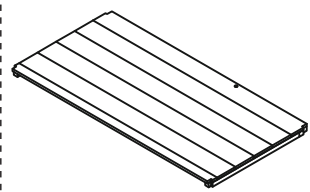

**M** x 1

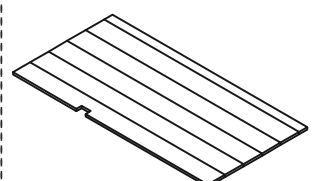

**N** x 1

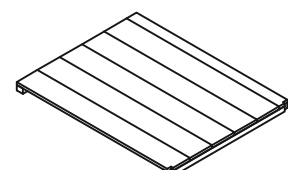

**O** x 6

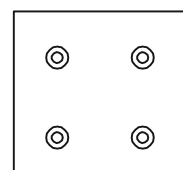

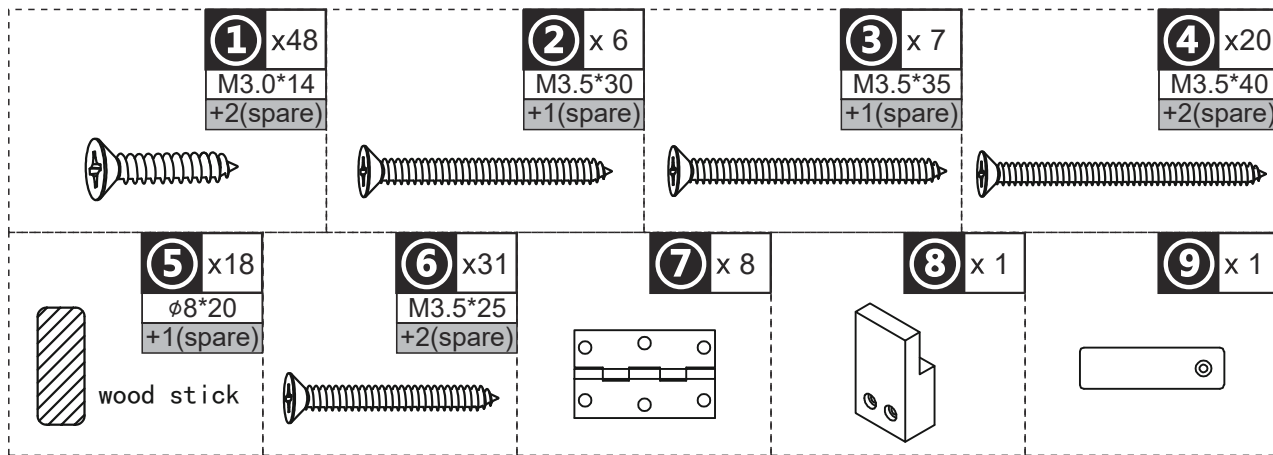

**EN** Do not confuse similar screws.  
**FR** Ne pas confondre des vis similaires.  
**ES** No confunda tornillos similares.  
**PT** Não confundir parafusos semelhantes.  
**DE** Verwechseln Sie ähnliche Schrauben nicht.  
**IT** Non confondere le viti simili.

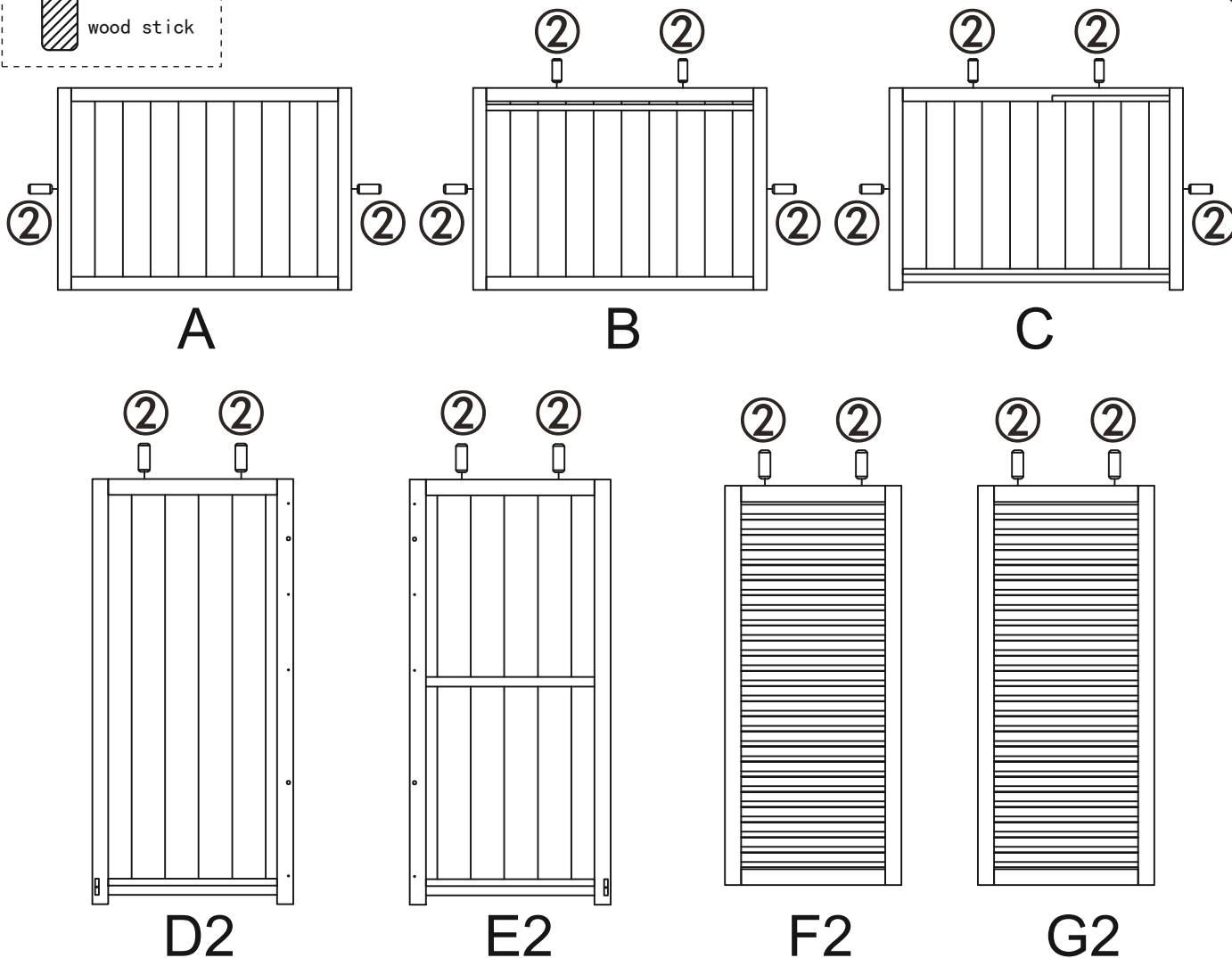

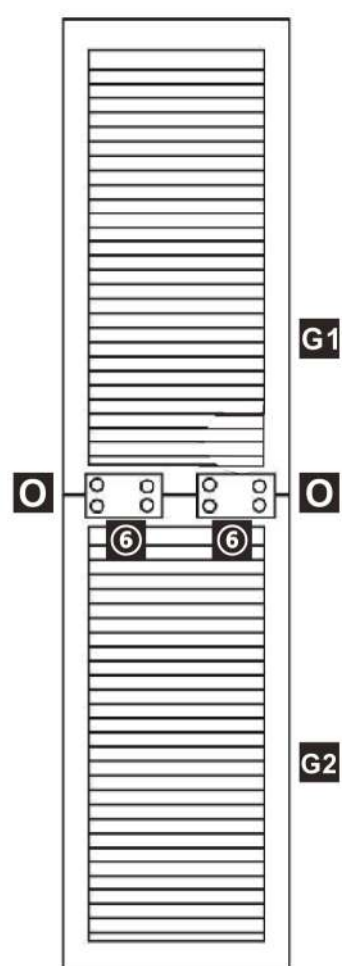
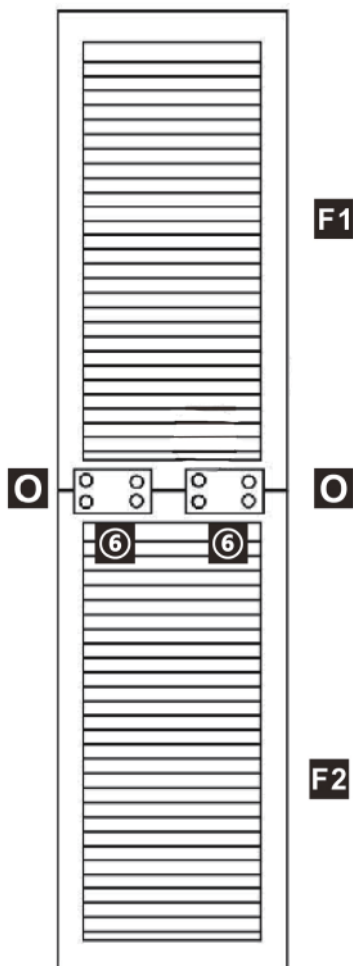
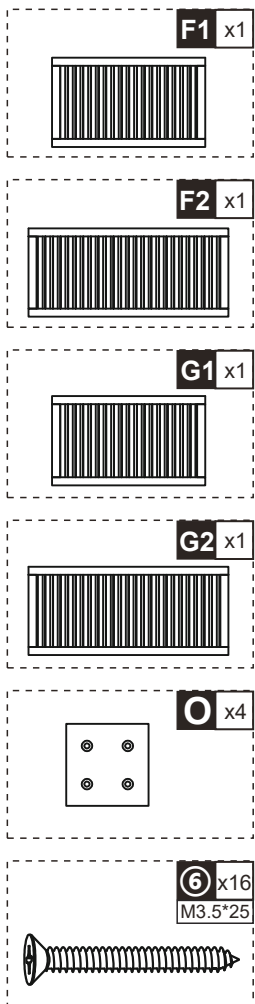
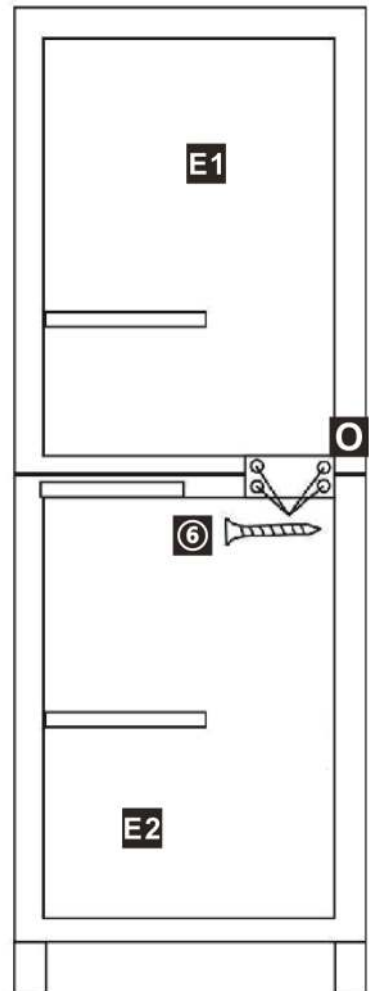
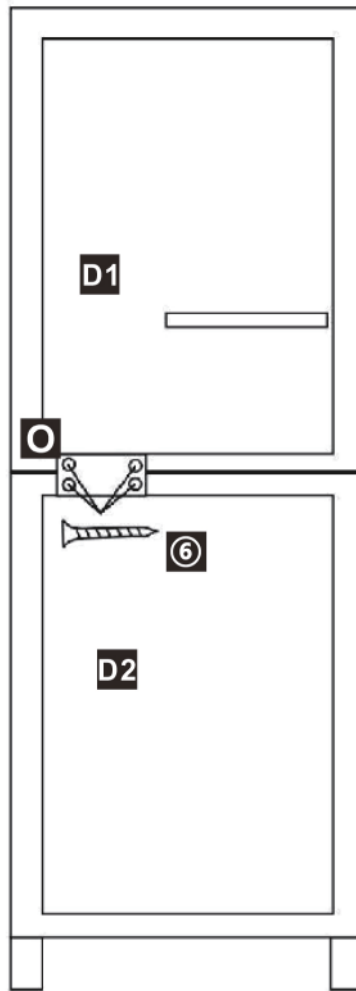
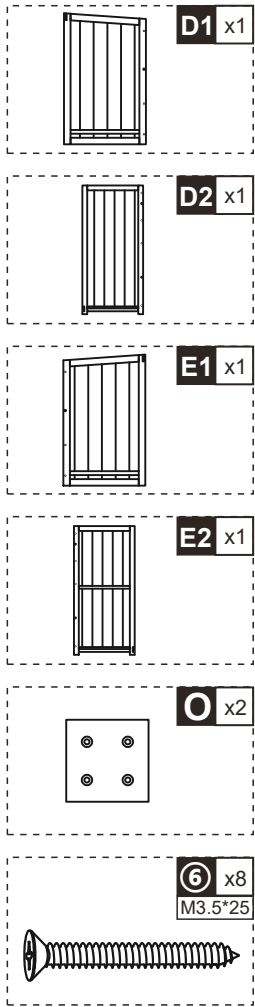

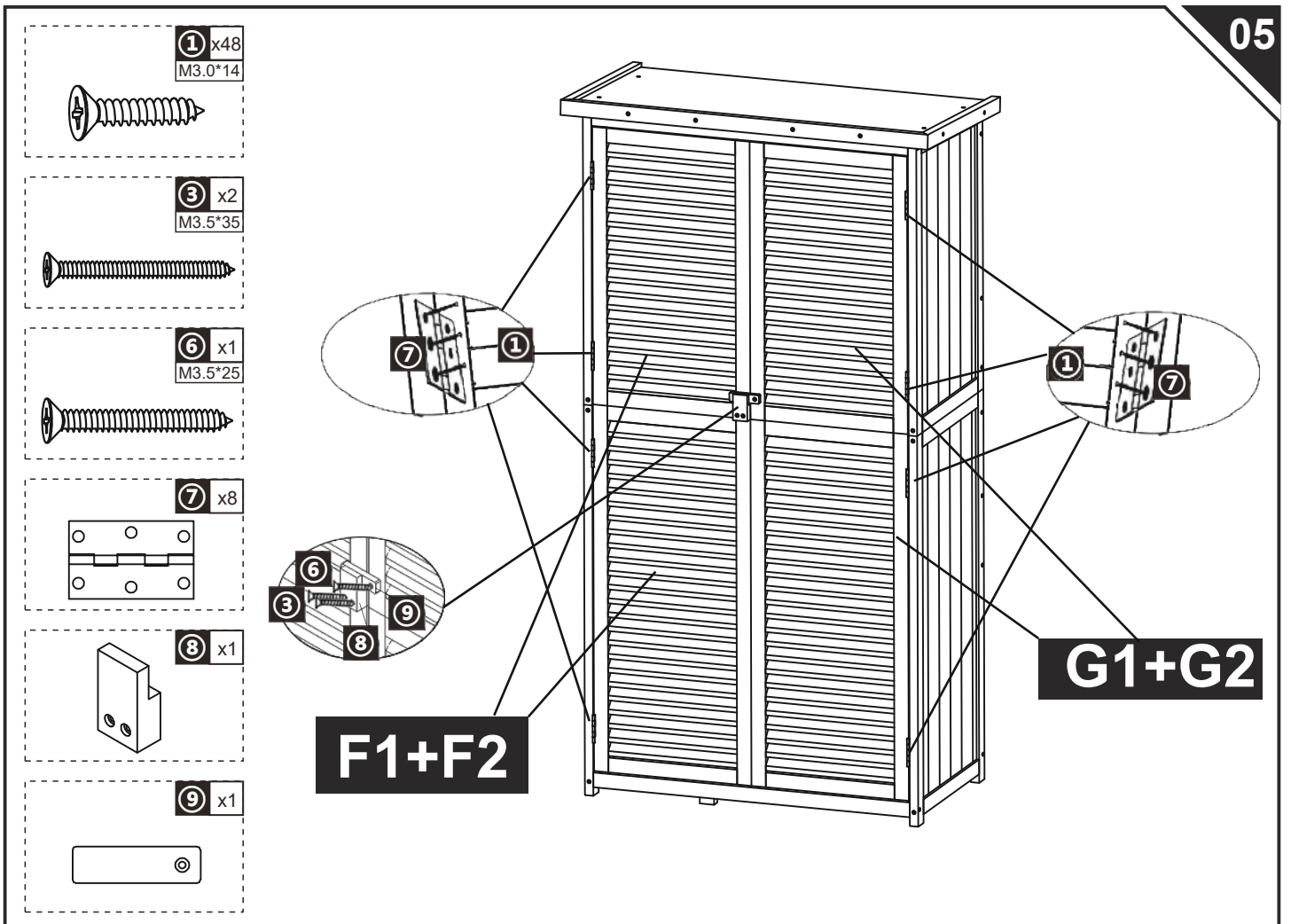
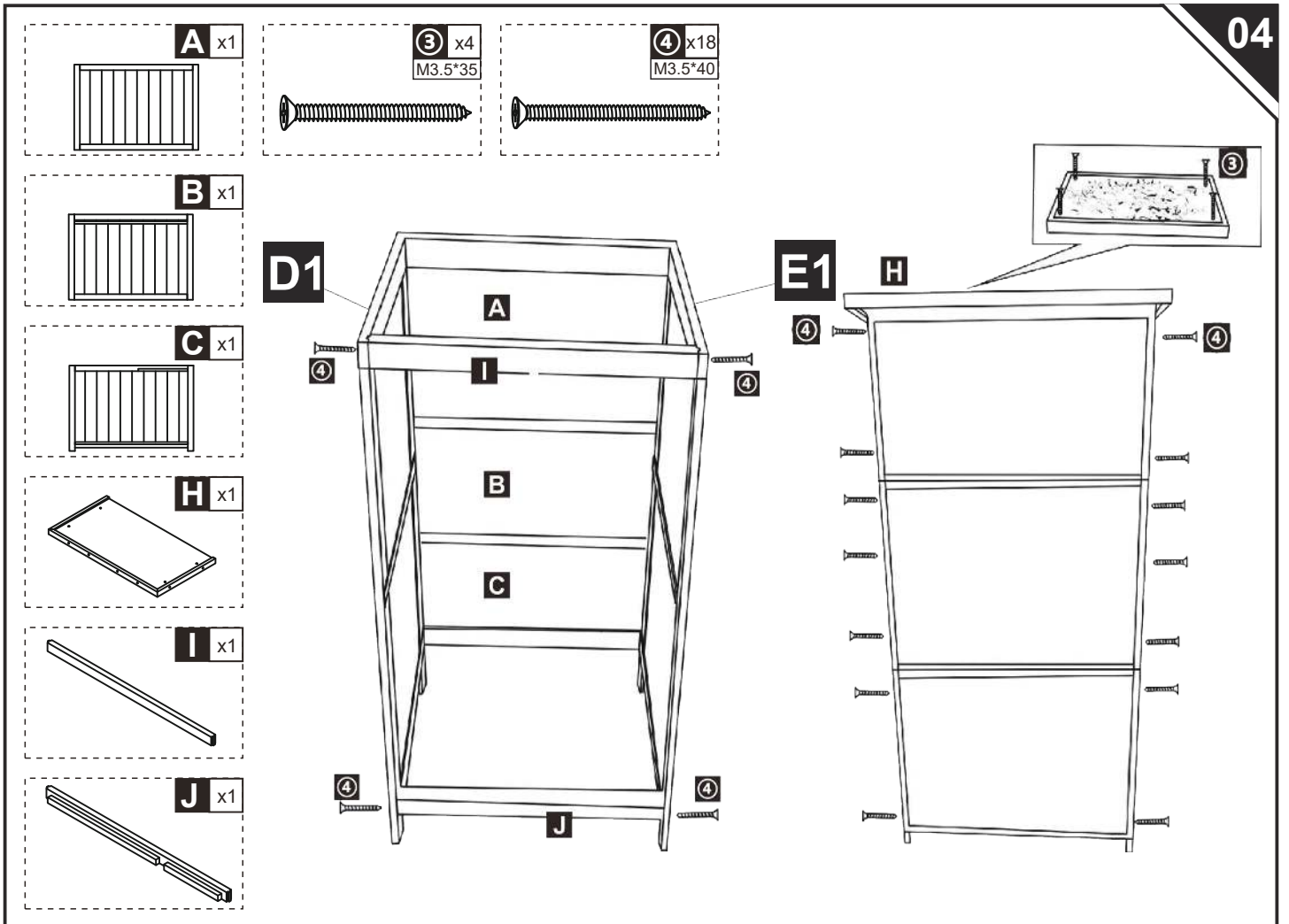

**K** x1



**L** x1



**N** x1

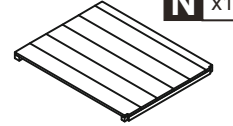

**2** x6  
M3.5\*30



**3** x1  
M3.5\*35



**4** x2  
M3.5\*40

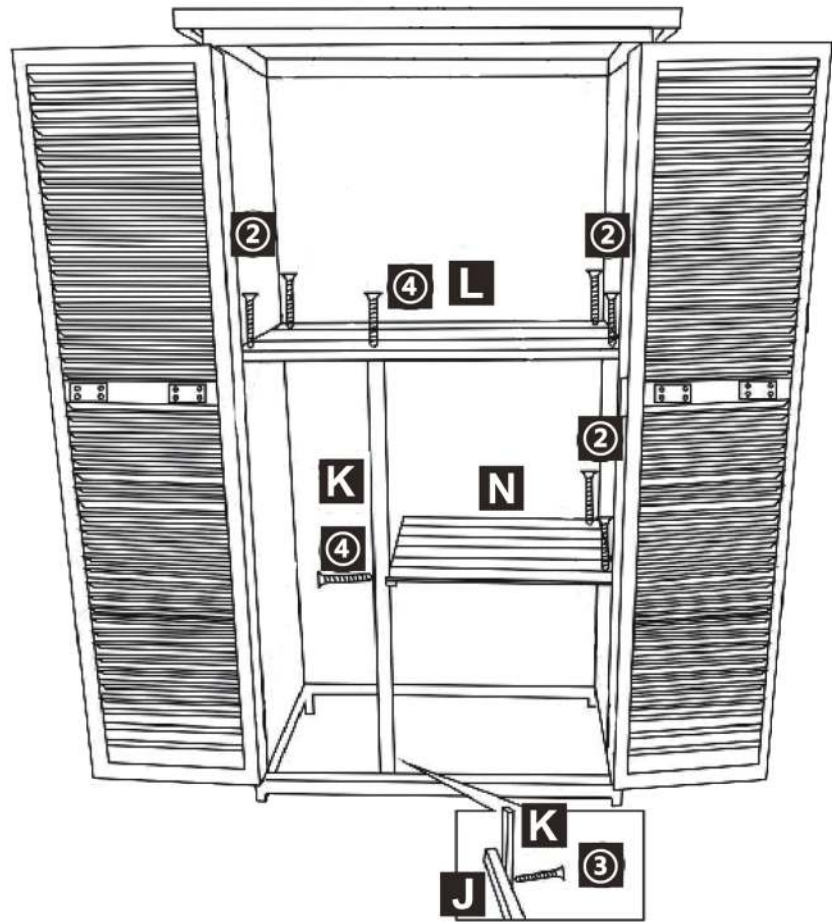

**M** x1

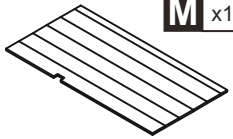

**6** x4  
M3.5\*25

