

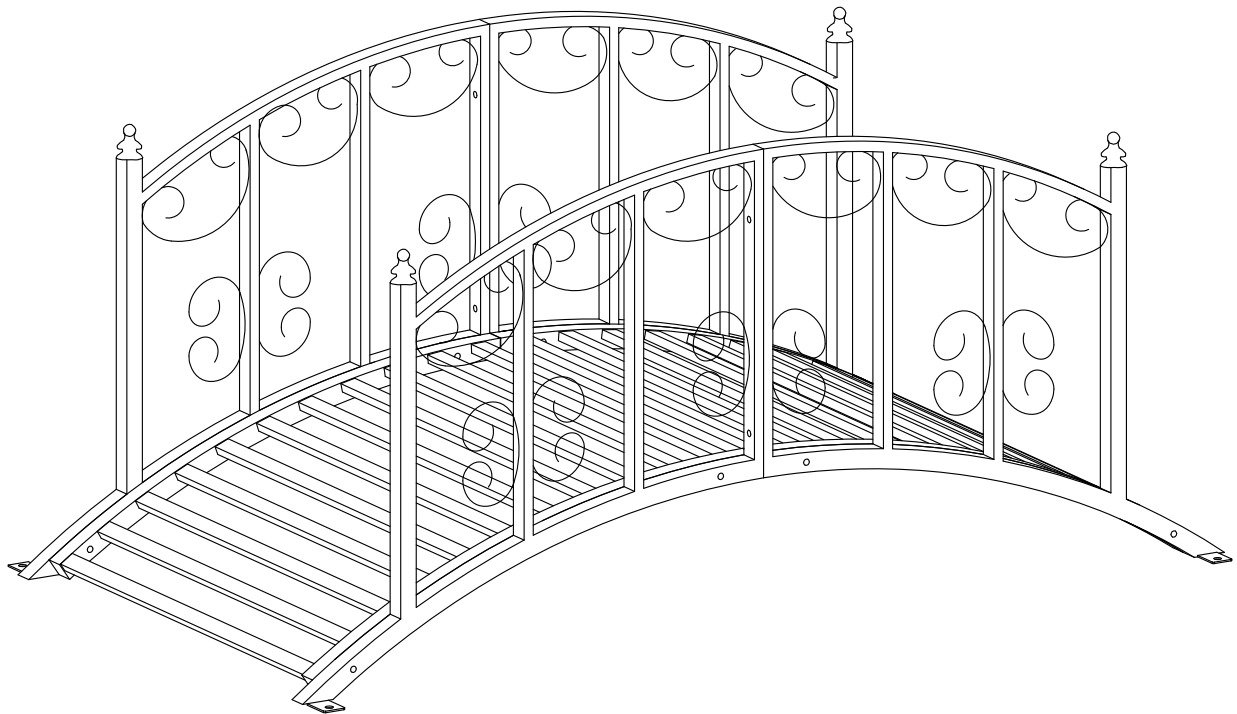

IN231000267V02\_GL

**844-775V00**



**EN\_IMPORTANT, RETAIN FOR FUTURE REFERENCE: READ CAREFULLY.**

**FR\_IMPORTANT: A LIRE ATTENTIVEMENT ET À CONSERVER POUR CONSULTATION ULTÉRIEURE.**

**ES\_IMPORTANTE, LEA Y GUARDE PARA FUTURAS REFERENCIAS.**

**PT\_IMPORTANTE, RETER PARA REFERÊNCIA FUTURA: LEIA ATENTAMENTE.**

**DE\_WICHTIG! SORGFÄLTIG LESEN UND FÜR SPÄTER NACHSCHLAGEN AUFBEWAHREN.**

**IT\_IMPORTANTE! CONSERVARE IL PRESENTE MANUALE PER FUTURO RIFERIMENTO E LEGGERLO ATTENTAMENTE.**

## PARTS

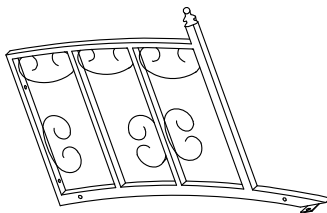
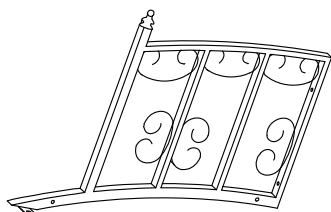
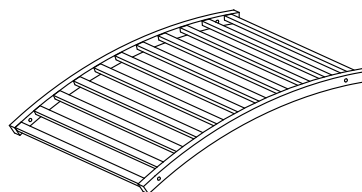
**A** x02**B** x02**C** x02

## HARDWARE

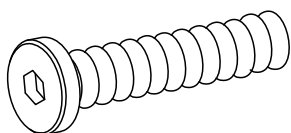
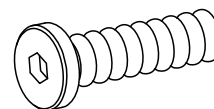
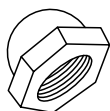
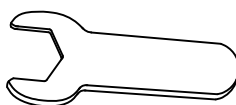
**D** x08  
+1(spare)**E** x04**F** x12  
+1(spare)**G** x01**H** x01

**EN**\_Do not confuse similar screws.Do not tighten bolts fully until all parts are connected!  
**FR**\_Ne pas confondre des vis similaires.Ne serrez pas les boulons à fond tant que toutes les pièces ne sont pas connectées!

**ES**\_No confunda tornillos similares.No apriete los tornillos completamente hasta que todas las partes están conectadas!

**PT**\_Não confundir parafusos semelhantes. Não apertar completamente os parafusos até que todas as peças estejam encaixadas!

**DE**\_Verwechseln Sie ähnliche Schrauben nicht.Ziehen Sie die Schrauben erst fest an, wenn alle Teile verbunden sind!

**IT**\_Non confondere le viti simili.non serrare completamente i bulloni fino a tutte le parti non sono ancora collegate!

## NOTE

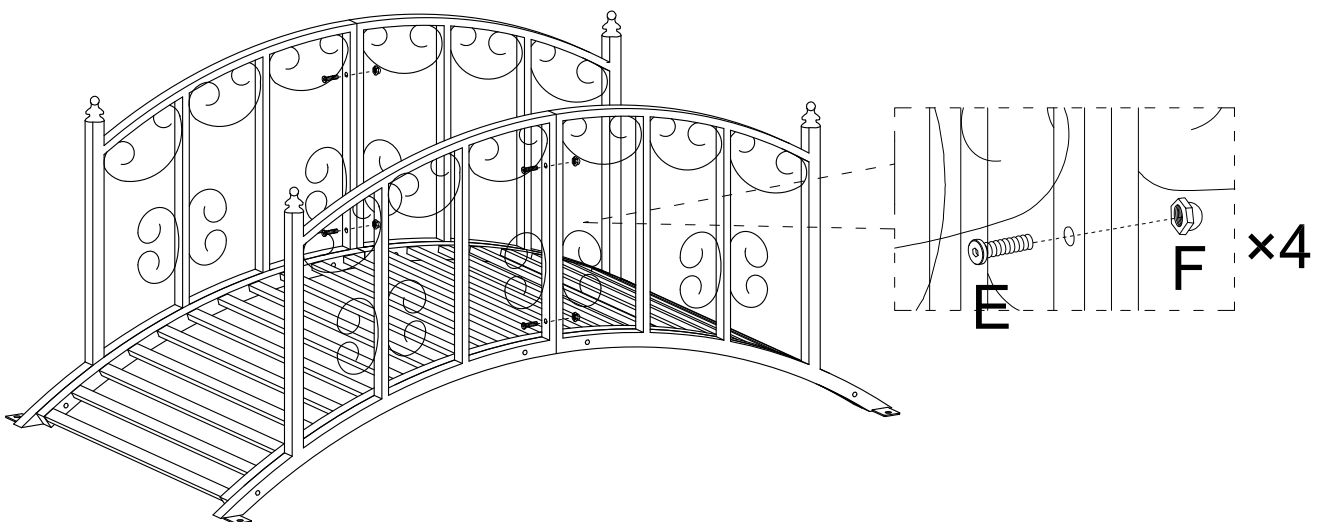
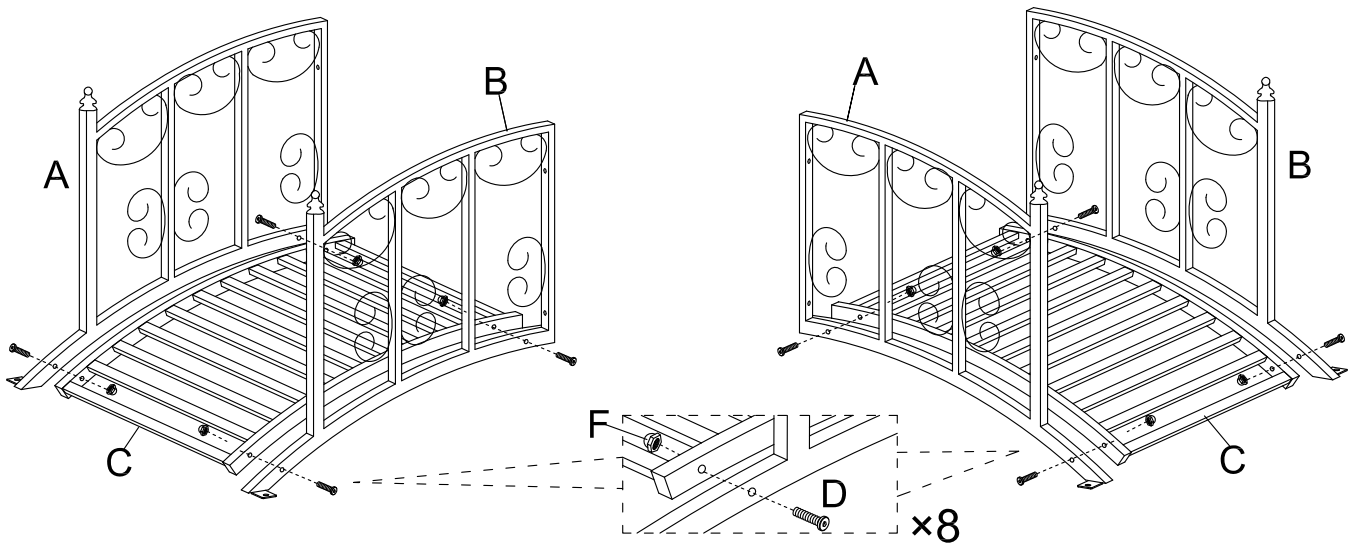

**EN** After installation, be sure to reinforce the product with expansion screws/ground nails.

**FR** Après l'installation, veuillez à renforcer le produit à l'aide de vis d'expansion/clous de sol.

**ES** Tras la instalación, asegúrese de reforzar el producto con tornillos de expansión/clavos de tierra.

**PT** Após a instalação, certifique-se de que reforça o produto com parafusos de expansão/pregos de solo.

**DE** Nach der Verlegung muss das Produkt mit Dehnschrauben/Bodennägeln verstärkt werden.

**IT** Dopo l'installazione, assicurarsi di rinforzare il prodotto con viti a espansione/chiodi a terra.

If you have any questions, please contact our customer care center.

Our contact details are below:

 001-877-644-9366

 customerservice@aosom.com

Imported by Aosom LLC

27150 SW Kinsman Rd Wilsonville, OR 97070 USA

MADE IN CHINA

**US**

Si tiene alguna pregunta, comuníquese con nuestro Centro de Atención al Cliente.

Nuestros datos de contacto son los siguientes:

 0034-931294512

 atencioncliente@aosom.es

IMPORTADOR:

SPANISH AOSOM, S.L.

C/ ROC GROS, Nº 15. 08550, ELS HOSTALETES DE BALENYÀ, SPAIN.

B66295775

WWW.AOSOM.ES

HECHO EN CHINA

**ES**

If you have any questions, please contact our customer care center.

Our contact details are below:

 416-792-6088

 customerservice@aosom.ca

Imported by Aosom Canada Inc.

7270 Woodbine Avenue, Unit 307, Markham,

Ontario Canada L3R 4B9

MADE IN CHINA

**CA**

Si vous avez la moindre question, veuillez contacter notre centre d'assistance à la clientèle.

Nos coordonnées sont les suivantes:

 416-792-6088

 customerservice@aosom.ca

Importé par Aosom Canada Inc.

7270 Woodbine Avenue, unité 307,

Markham, Ontario Canada L3R 4B9

Fabriqué en Chine

**PT**

Se tiver alguma dúvida, por favor contacte o nosso Centro de Atendimento ao Cliente.

Os nossos dados de contacto são os seguintes:

 0034-931294512 (SEG-SEX DAS 7:30H ÀS 16:30H)

 info@aosom.pt.

IMPORTADOR:

SPANISH AOSOM, S.L

C.ROC GROS N.15, 08550. ELS HOSTALETES DE BALENYÀ

WWW.AOSOM.PT

**DE**

Wenn Sie Fragen haben, wenden Sie sich bitte an unser Kundendienstzentrum.

Unsere Kontaktdaten stehen unten:

 0049-0(40)-88307530  service@aosom.de

ADRESSE DES IMPORTEURE:

MH Handel GmbH

Wendenstraße 309

D-20537 Hamburg

Germany

IN CHINA HERGESTELLT

If you have any questions, please contact our customer care center.

Our contact details are below:

 0044-800-240-4004

 enquiries@mhstar.co.uk

IMPORTER ADDRESS:

MH STAR UK LTD

Unit 27, Perivale Park,

Horsenden lane South

Perivale, UB6 7RH

MADE IN CHINA

**UK**

In caso di dubbio, si prega di contattare il nostro centro assistenza clienti.

I nostri dettagli di contatto sono di seguito:

 0039-0249471447  clienti@aosom.it

IMPORTATO DA:

AOSOM Italy srl

Centro Direzionale Milanofiori

Strada 1 Palazzo F1

20057 Assago (MI)

P.I.: 08567220960

FATTO IN CINA

**IT**

Si vous avez la moindre question, veuillez contacter notre centre d'assistance à la clientèle.

Nos coordonnées sont les suivantes:  0033-1-84166106  aosom@mhfrance.fr

Importé par: MH France 2, rue Maurice Hartmann 92130 Issy-les-Moulineaux

Fabriqué en Chine

France

**FR**



FR

**DONNEZ  
OU  
RECYCLEZ**



OU



OU



ASSOCIATION LIVRAISON DÉCHÈTERIE

Adresses sur [quefairedemesdechets.fr](http://quefairedemesdechets.fr)