



EN\_ IMPORTANT, RETAIN FOR FUTURE REFERENCE: READ CAREFULLY.

FR\_ IMPORTANT: A LIRE ATTENTIVEMENT ET A CONSERVER POUR VOUS Y REFRERER ULTERIEUREMENT.

ES\_ IMPORTANTE, LEA DETENIDAMENTE Y GUARDE PARA FUTURAS REFERENCIAS.

PT\_ IMPORTANTE, GUARDE PARA FUTURA REFERÊNCIA, LEIA ATENTAMENTE.

DE\_ WICHTIG! SORGFÄLTIG LESEN UND FÜR SPÄTER NACHSCHLAGEN AUFBEWAHREN.

IT\_ IMPORTANTE, LEGGERE E CONSERVARE QUESTO MANUALE D'ISTRUZIONE PER UN USO FUTURO.

**EN**

**Dear customer,**

Thank you for purchasing this product. So that your appliance serves you well, please read all the instructions in this user's manual. If you have any questions, please contact our customer care center.

**FR**

**Cher client,**

Nous vous remercions d'avoir acheté ce produit. Afin que vous puissiez profiter pleinement de votre appareil, veuillez lire toutes les instructions de ce manuel d'utilisation. Si vous avez la moindre question, veuillez contacter notre centre d'assistance à la clientèle.

**DE**

**Sehr geehrter Kunde,**

Vielen Dank, dass Sie dieses Produkt erworben haben. Damit Ihr Gerät Ihnen gute Dienste leistet, lesen Sie bitte alle Hinweise in diesem Benutzerhandbuch. Wenn Sie Fragen haben, wenden Sie sich bitte an unser Kundendienstzentrum.

**ES**

**Queridos clientes,**

Gracias por comprar este producto. Para que su electrodoméstico le sirva mejor, lea todas las instrucciones de este manual del usuario. Si tiene alguna pregunta, comuníquese con nuestro Centro de Atención al Cliente.

**PT**

**Caros clientes,**

Obrigado por adquirir este produto. Para que o seu aparelho o sirva melhor, leia todas as instruções deste manual do utilizador. Se tiver alguma dúvida, por favor contacte o nosso Centro de Atendimento ao Cliente.

**IT**

**Caro Cliente,**

Grazie per aver acquistato questo prodotto. Per servirti meglio con questo apparecchio ti prego di leggere tutte le istruzioni in presente manuale utente. In caso di dubbio, si prega di contattare il nostro centro assistenza clienti.

**EN\_Our contact details are below:**



**FR\_Nos coordonnées sont les suivantes:**











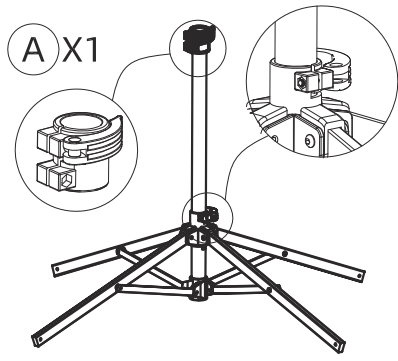

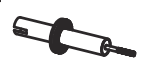
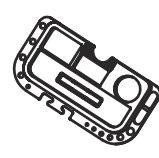

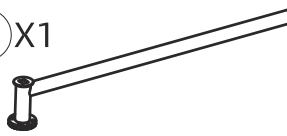
**DE\_Unsere Kontaktdaten stehen unten:**

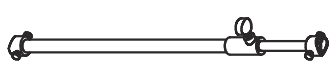
**ES\_Nuestros datos de contacto son los siguientes:**

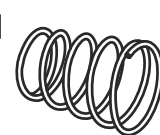
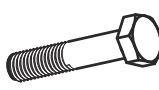
**PT\_Os nossos dados de contacto são os seguintes:**

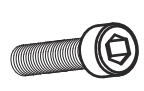
**IT\_I nostri dettagli di contatto sono di seguito:**

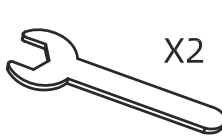
Country	 Phone	 Email
UK	0044-800-240-4004	enquiries@mhstar.co.uk
DE	0049-0(40)-88307530	service@aosom.de
FR	0033-1-84166106	aosom@mhfrance.fr
ES	0034-931294512	atencioncliente@aosom.es
PT	0034-931294512	info@aosom.pt.
IT	0039-0249471447	clienti@aosom.it
US	001-877-644-9366	customerservice@aosom.com
CA	416-792-6088	customerservice@aosom.ca

<p><b>A</b> X1</p> 	<p><b>G</b> X4</p> 	<p><b>H</b> X4</p> 
<p><b>B</b> X1</p> 	<p><b>D</b> X1</p> 	<p><b>F</b> X1</p> 
<p><b>C</b> X1</p> 	<p><b>P</b> X1</p> 	<p><b>S</b> X1</p> 
<p><b>E</b> X1</p> 	<p><b>J</b> X2</p> 	<p><b>R</b> X1</p> 
<p><b>L</b> X4</p> 	<p><b>M</b> X4</p> <p>M6</p> 	<p><b>K</b> X2</p> <p>M6*28</p> 
<p><b>V</b> X1</p> <p>M8</p> 	<p>X1</p> 	<p>X2</p> 
<p>X1</p> 		

**STEP1**

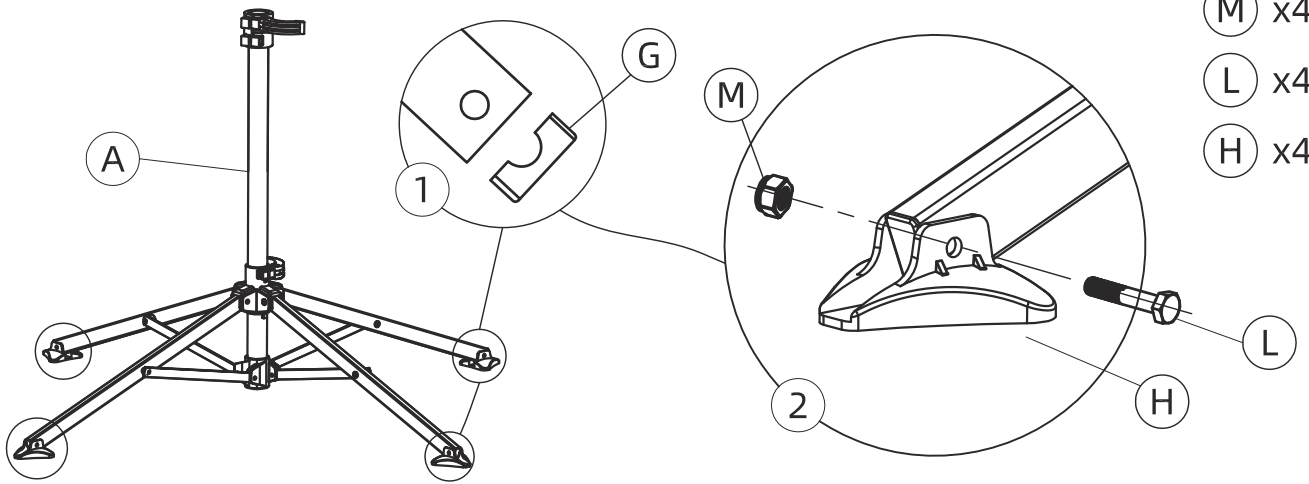

- (A) x1
- (G) x4
- (M) x4
- (L) x4
- (H) x4

**STEP2**

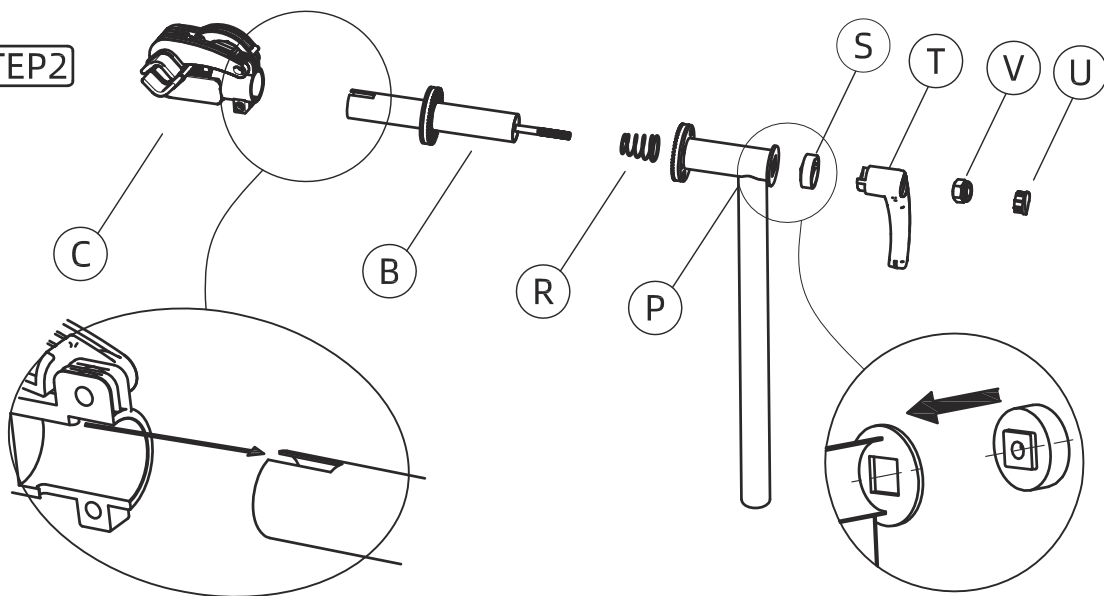

- (B) x1
- (C) x1
- (R) x1
- (P) x1
- (S) x1
- (T) x1
- (V) x1
- (U) x1

**STEP3**

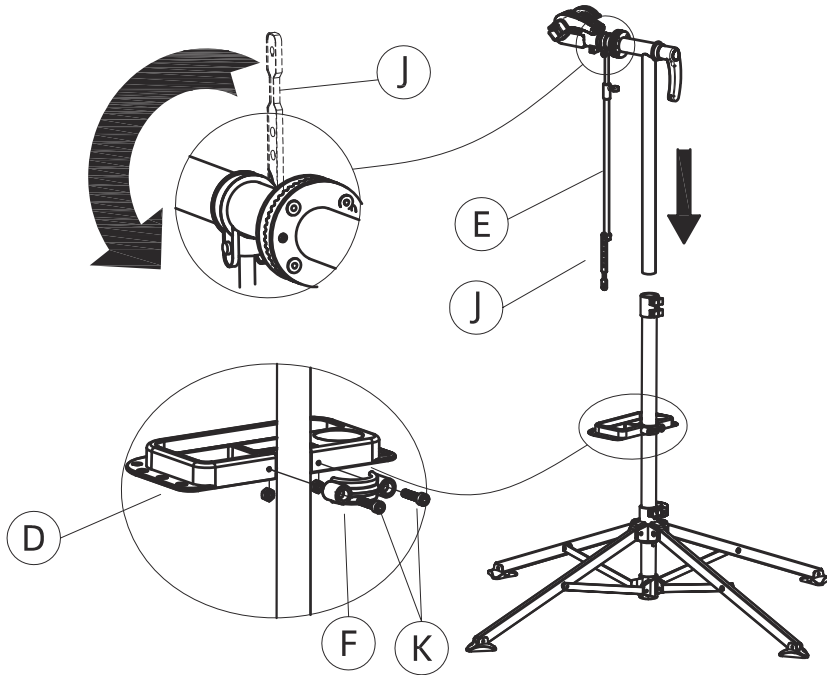

- (D) x1
- (E) x1
- (F) x1
- (J) x2
- (K) x2

**US\_ IMPORTER:**

Imported by Aosom LLC  
27150 SW Kinsman Rd Wilsonville, OR 97070 USA  
MADE IN CHINA

**CA\_ IMPORTER / IMPORTÉ PAR:**

Imported by Aosom Canada Inc.  
7270 Woodbine Avenue, Unit 307, Markham, Ontario Canada L3R 4B9  
MADE IN CHINA

Importé par Aosom Canada Inc.  
7270 Woodbine Avenue, unité 307, Markham, Ontario Canada L3R 4B9  
Fabriqué en Chine

**UK\_ IMPORTER:**

MH STAR UK LTD  
Unit 27, Perivale Park, Horsenden lane South  
Perivale, UB6 7RH  
MADE IN CHINA

**DE\_ IMPORTATEUR:**

MH Handel GmbH  
Wendenstraße 309  
D-20537 Hamburg  
Germany  
IN CHINA HERGESTELLT

**FR\_ IMPORTÉ PAR:**

MH France  
2, rue Maurice Hartmann  
92130 Issy-les-Moulineaux  
France  
Fabriqué en Chine

**IT\_ IMPORTATO:**

AOSOM Italy srl  
Centro Direzionale Milanofiori  
Strada 1 Palazzo F1  
20057 Assago (MI)  
P.I.: 08567220960  
FATTO IN CINA

**ES/PT\_ IMPORTADOR:**

SPANISH AOSOM, S.L.  
C/ ROC GROS, N° 15. 08550, ELS HOSTALETS DE  
BALENYÀ, SPAIN.  
B66295775  
WWW.AOSOM.ES  
ATENCIONCLIENTE@AOSOM.ES  
TEL: 931294512  
HECHO EN CHINA

SPANISH AOSOM, S.L.  
C.ROC GROS N.15, 08550. ELS HOSTALETS DE BALENYÀ  
TEL: 931294512 (SEG-SEX DAS 7:30H ÀS 16:30H)  
INFO@AOSOM.PT  
WWW.AOSOM.PT