

PawHüt!

IN240500112V01_GL

D00-041_GL_D00-041V00

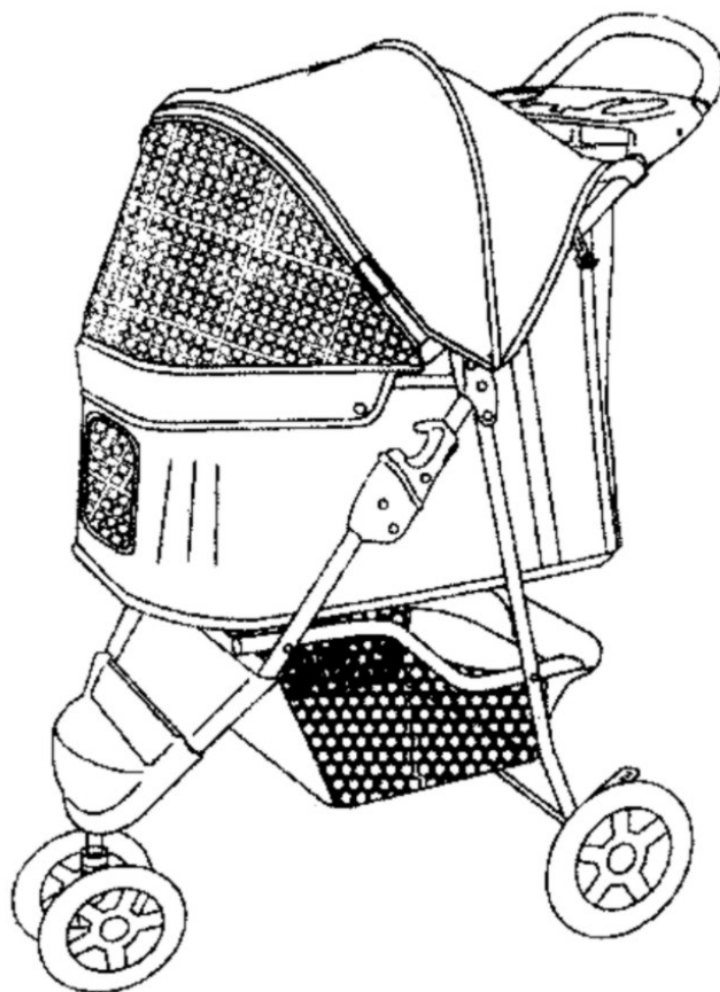

EN_IMPORTANT, RETAIN FOR FUTURE REFERENCE: READ CAREFULLY.

**FR_IMPORTANT: A LIRE ATTENTIVEMENT ET À CONSERVER POUR CONSULTATION
ULTÉRIEURE.**

ES_IMPORTANTE, LEA Y GUARDE PARA FUTURAS REFERENCIAS.

PT_IMPORTANTE, RETER PARA REFERÊNCIA FUTURA: LEIA ATENTAMENTE.

DE_WICHTIG! SORFGFÄLTIG LESEN UND FÜR SPÄTERES NACHSCHLAGEN AUFBEWAHREN.

**IT_IMPORTANTE! CONSERVARE IL PRESENTE MANUALE PER FUTURO RIFERIMENTO E
LEggerlo ATTENTAMENTE.**

Parts

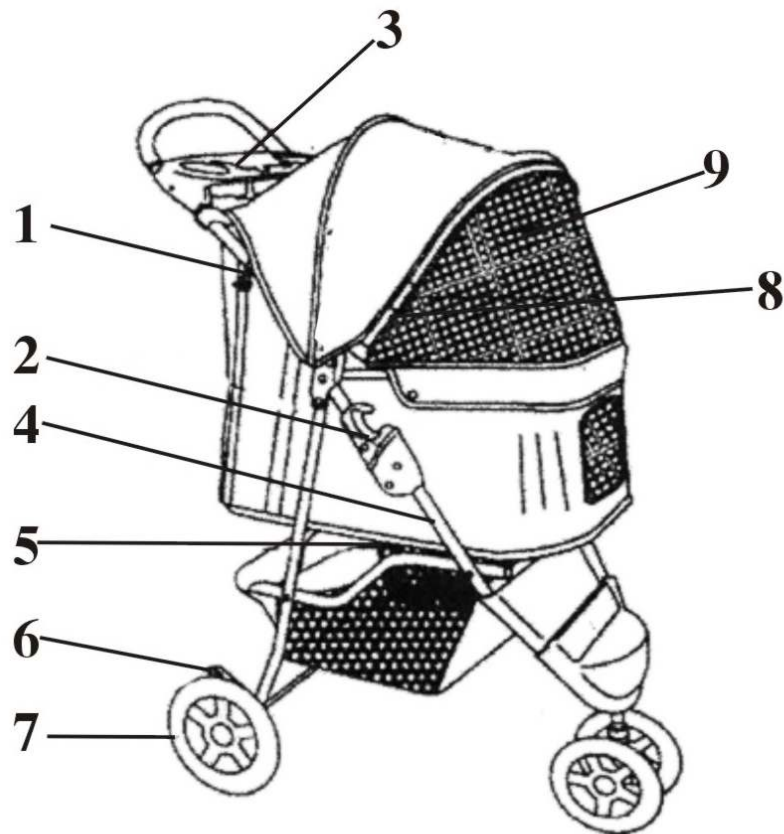

1. Safety lock
2. Side locks
3. Teacup tray
4. Main frame
5. Touch-fastening straps
6. Brakes
7. Rear wheels
8. Zip
9. Canopy

To open

1. Release the side safety lock(1) on the main frame(4)

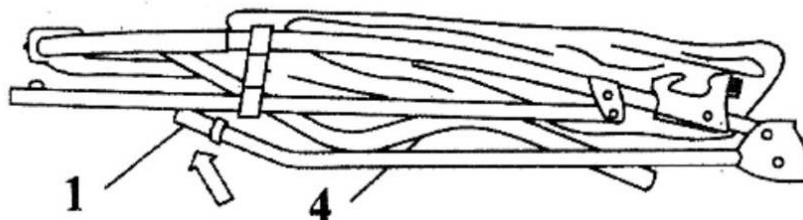

2. Unfold the pet stroller and lock into place. Ensure that both side locks (2) are properly secured

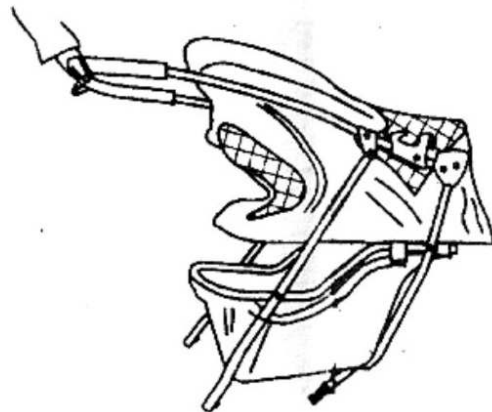

3. Insert the front wheels assembly onto the front wheel frame until the locking button of the front wheel frame spring out .

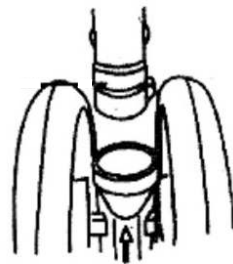

4. Push the rear wheels, gasket , clip, cover assembly into the axle. And then push it assembly into the frame until spring out on the assembly.

(To disassemble: press the spring on the rear wheel frame and remove the assembly.)

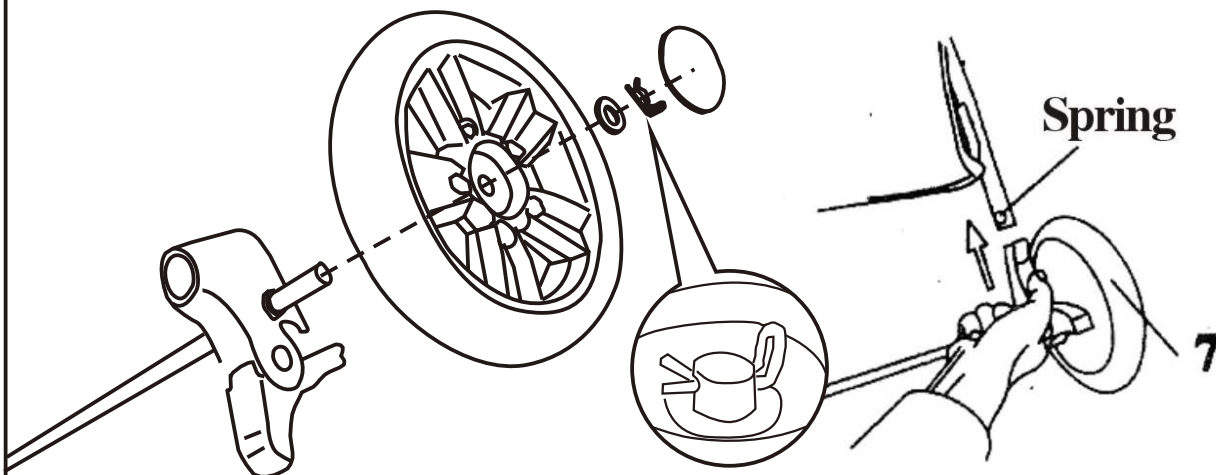

5. The zip on the basket should be zipped to the front.

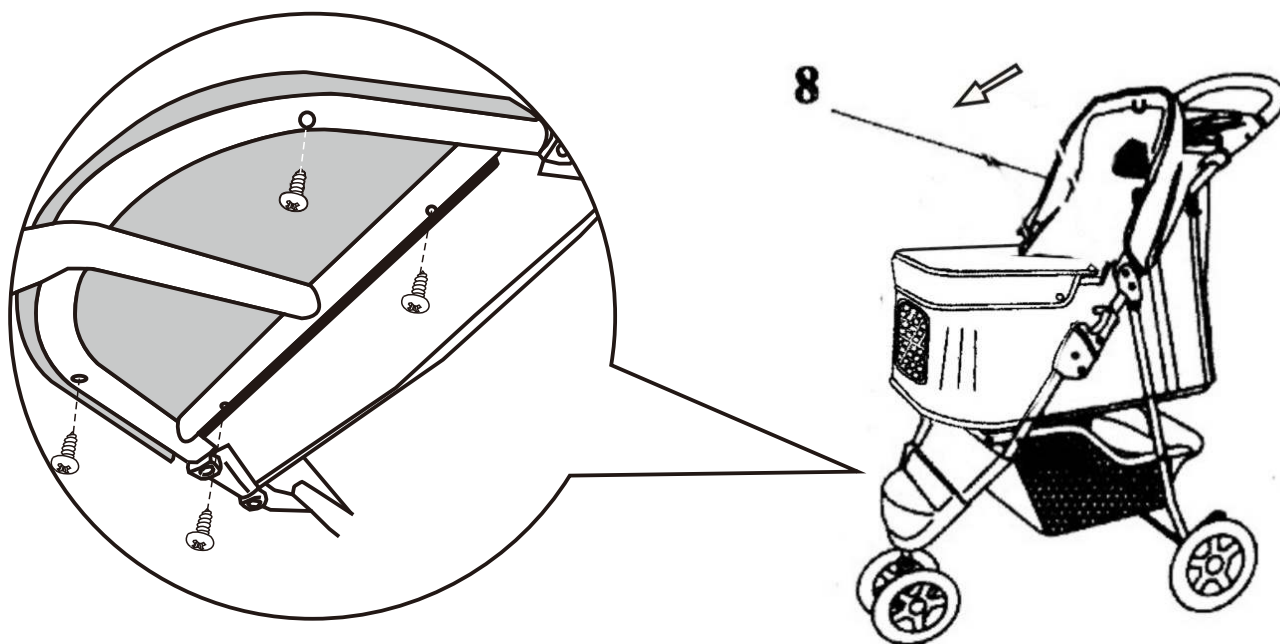

Brakes

1. For your pet's safety, always apply the brakes (6) when the pet stroller is stationary

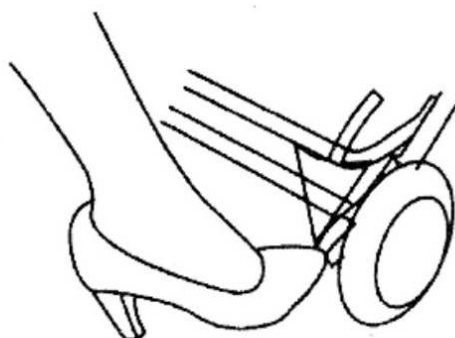

2. Lock the rear wheels by simply pushing down the brake levers on either side

To fold

1. Unzipped the zip on the basket.
2. Lift the canopy supports(3).
3. Pull up both side locks(2).
4. Fold the pet stroller.
5. Secure the side safety lock(1).



Cleaning and maintenance

1. Undo the touch-fastening straps(5) under the basket.
2. Unscrew the six screws of the canopy supports and remove the canopy from the main frame(4).
3. Slide off the lining.
4. Undo the touch-fastening straps(5) and remove the hard base.
5. Wipe clean the main cover with a damp cloth.
6. Unzip cushion cover, remove sponge inner and hand wash cover in lukewarm water.

PACKING LIST

N ^o	PARTS NAME	QTY.
1	Main frame	1
2	Front wheels	1
3	Axle component	1
4	Teacup tray	1
5	Front faceplate	1
6	Sponge cushion	1
7	Bottom basket	1
8	Rear tire	2
9	Cover	2
10	Clip	2
11	Screw(4x12)	4
12	Use instruction	1

The pet stroller has been specifically designed for taking pets to the vet and for taking elderly or nervous pets with hip or general mobility problems, on outings. The stroller is lightweight and easy to manoeuvre

⚠ WARNING:

For the safety your pet, please read the following and keep for future reference.



Caution

1. Do not lift up the stroller when the pet is in.
2. Never use the stroller at uneven place.
3. Never use the stroller near the fire or other dangerous area.
4. Must use the brakes when you stop moving your stroller.
5. Do not put two or more than two pets in one stroller.
6. Do not store or use this stroller in areas exposed to high or low temperature or humidity for a long time.
7. Maximun pet weight for this strollers 15kgs.

PawHut



1. Verrou de sécurité
2. Verrous latéraux
3. Plateau pour tasse de thé
4. Cadre (châssis) principal
5. Sangle de fixation tactile
6. Freins
7. Roues arrières
8. Fermeture éclair
9. Pare soleil

Ouvrir votre poussette

1. Libérer le verrou de sécurité latéral (1) situé sur le cadre principal(4)

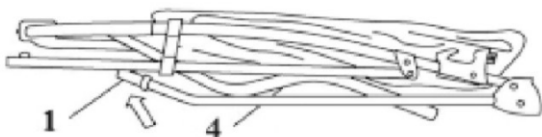

2. Déplier et serrer le verrou de la poussette de votre animal de compagnie. Il faut s'assurer que les deux verrous latéraux(2) sont correctement serrés.



3. Insérer les roues avant sur le châssis de la roue avant jusqu'à ce que le bouton de verrouillage sur le châssis de roue ressorte en avant.

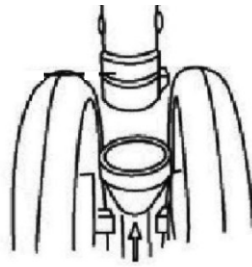

locking button : bouton (ou point) de verrouillage

4. Mettre les roues arrières, les joints, agrafe(clip), sur l'essieu. Fermer ensuite l'ensemble ainsi constitué grâce à un couvercle. Pousser l'ensemble dans le cadre avant de serrer avec un ressort. (DEMONTAGE: Appuyer le ressort situé dans le cadre de la roue arrière et enlevez l'ensemble.)

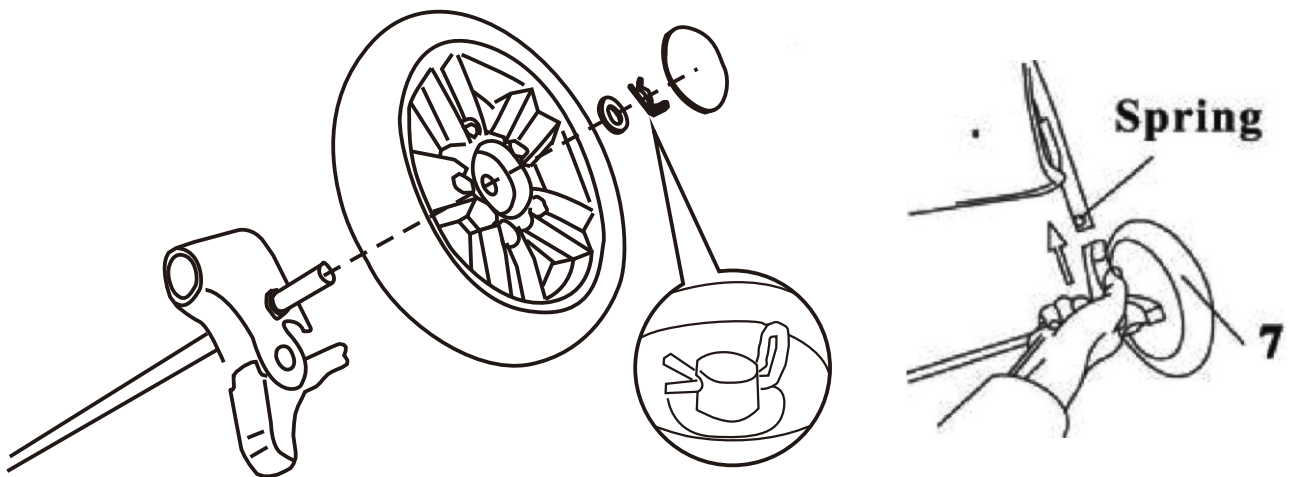

5. La fermeture éclair sur le panier doit être fermée vers l'avant.

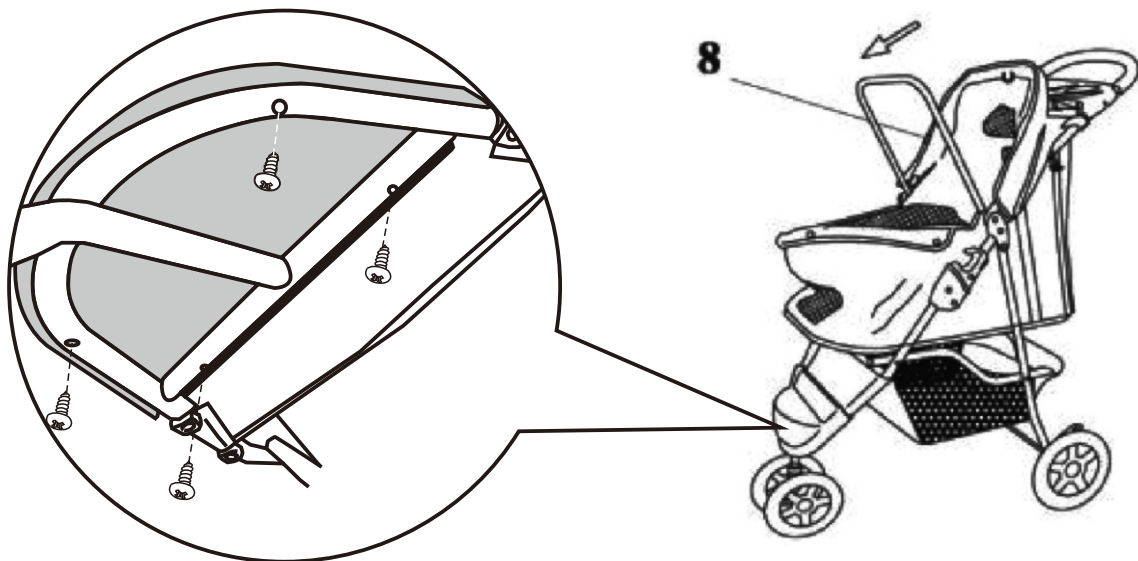

Les freins

1. Pour la sécurité de votre animal, il faut toujours utiliser les freins (6) quand vous arrêtez la poussette lors de vos promenades.

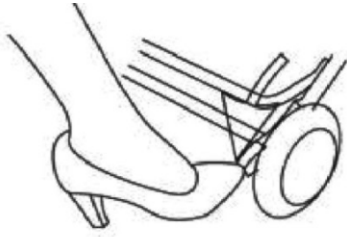

2. Verrouillez simplement les roues arrière, en poussant vers le bas les leviers de frein de chaque côté.

Replier pour rangement

1. Ouvrir la fermeture éclair située sur le panier.
2. Enlever les supports de la verrière (3).
3. Déserrer tous les verrous latéraux(2).
4. Plier la poussette de l'animal.
5. Verrouiller grâce au verrou de sécurité latéral (1).

Attention :

Pour la sécurité de votre animal, il est important de lire et de garder le manuel d'instructions avant l'utilisation. Ce manuel vous servira également de référence.

Nettoyage et entretien

1. Défaire les sangles de fixations tactiles(5) sous le panier.
2. Dévisser les six vis des supports du pare soleil.
le du cadre principal(4).
3. Faites glisser la doublure.
4. Défaire les sangles de fixations tactiles(5) retirer la base.
5. Essuyer le capot principal avec un chiffon humide
6. Enlever housse de coussin, retirez l'éponge , la couvercle intérieure et laver à la main à l'eau tiède.

CONTENU DU COLIS

No	Composant	Quantité
1	Cadre principal	1
2	Roues avant	1
3	Composante d'essieu	1
4	Plateau pour tasse de thé	1
5	Plaque frontale	1

6	Coussin	1
7	Panier du bas	1
8	Pneu arrière	2
9	Couverture	2
10	Agrafe/clip	2
11	Vis (4*12)	4
12	Manuel d'instructions	1

Précautions



1. Ne pas soulever la poussette lorsque votre animal se trouve à l'intérieur.
2. Ne jamais utiliser la poussette dans des endroits ou sur des espaces inappropriés
3. Ne jamais utiliser la poussette près du feu ou dans des zones dangereuses.
4. Il faut utiliser les freins lorsque vous voulez arrêter de votre poussette.
5. Ne pas installer deux ou plusieurs animaux dans une poussette.
6. Ne pas utiliser ou exposer la poussette pendant un long moment dans les zones humides ou à haute température.
7. La poussette peut supporter un animal dont le poids est inférieur ou égal à 15kg.

La poussette pour animaux de compagnie a été spécialement conçue pour faciliter vos déplacements avec votre animal de compagnie quand vous rendez chez le vétérinaire. Aussi, elle vous permet de transporter vos animaux nerveux, âgés, et/ou ayant des problèmes de mobilité générale.

La poussette est légère et facile à manipuler.

Partes

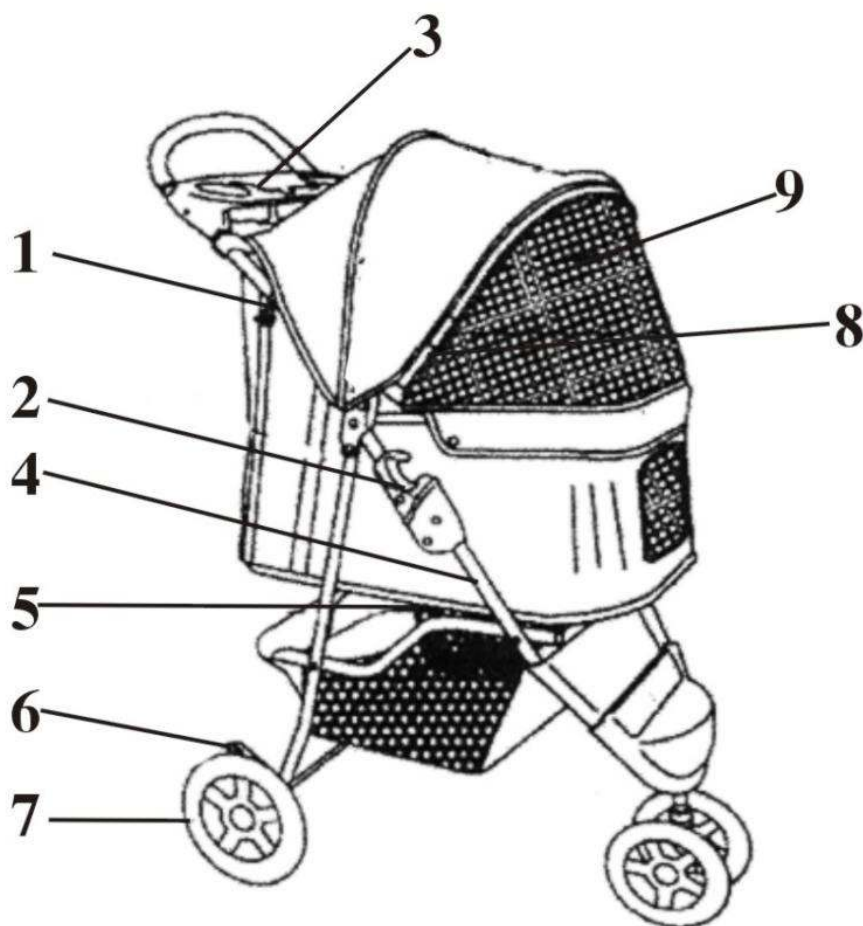

1. Bloqueo de seguridad
2. Bloqueos laterales
3. Bandeja de la taza
4. Marco principal
5. Correas de sujeción
6. Frenos
7. Ruedas traseras
8. Cremallera
9. Dosel

Abrir

1. Suelte el bloqueo de seguridad lateral (1) en la granja principal (4)

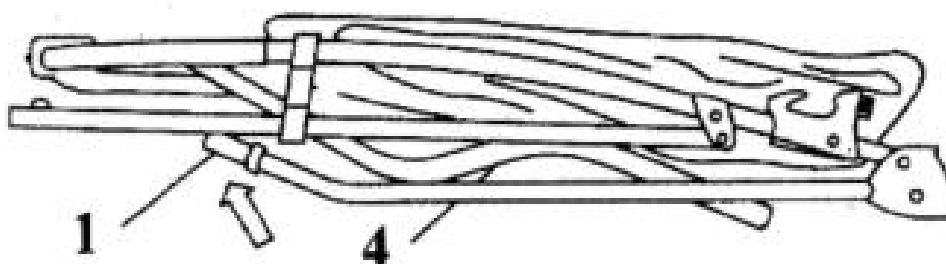

2. Despliegue el cochecito para mascotas y lo bloquear en su lugar. Asegúrese de que ambos seguros laterales (2) estén bien asegurados.

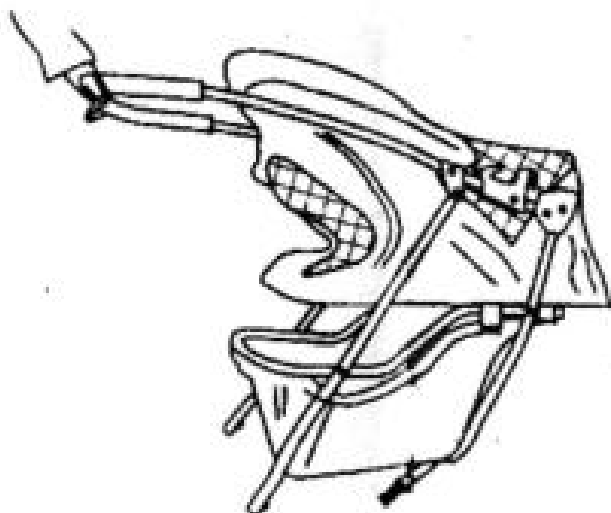

3. Inserte el conjunto de las ruedas delanteras en el marco de la rueda delantera hasta que el botón de bloqueo del marco salte hacia afuera.

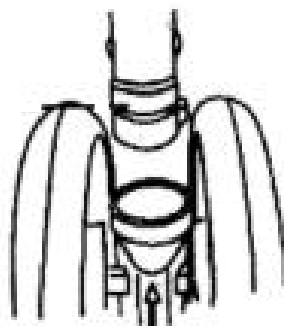

4. Empuje las ruedas traseras, la junta, el clip y el conjunto de la cubierta en el eje. Y luego empuje el ensamblaje en el marco hasta que salga del ensamblaje. (Para desmontar: presione el resorte en el marco de la rueda trasera y retire el conjunto).

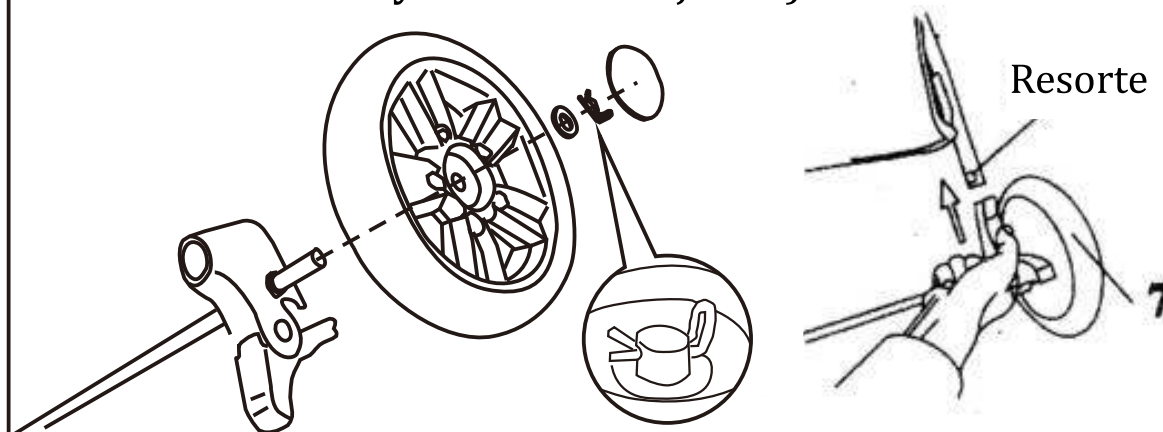

5. La cremallera de la cesta debe estar con cremallera en la parte delantera.

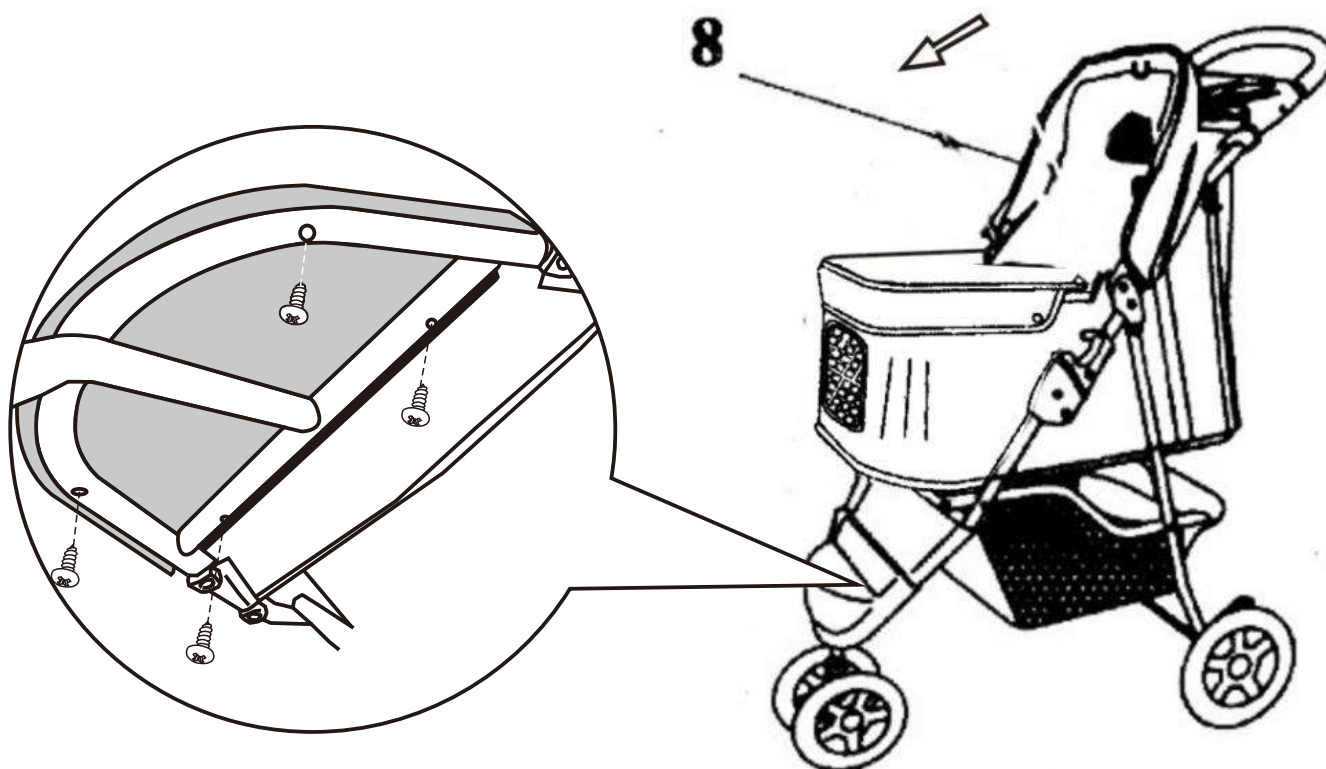

Frenos

1. Para la seguridad de su mascota, siempre aplique los frenos (6) cuando el cochecito de la mascota esté parado.

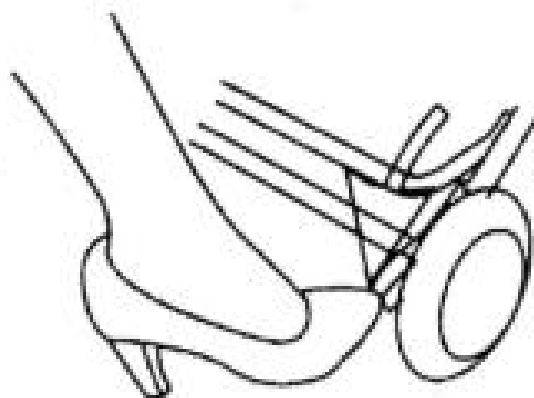

2. Bloquee las ruedas traseras simplemente empujando hacia abajo las palancas de freno en ambos lados

Plegar



1. Descomprimido la cremallera en la cesta.
2. Levante los soportes del dosel (3)
3. Levante ambos bloqueos laterales (2)
4. Doble el cochecito pel
5. Asegure el bloqueo de seguridad lateral (1)

Limpieza y mantenimiento

1. Deshaga las correas de sujeción (5) debajo de la canasta.
2. Desatornille los seis tornillos de los soportes del dosel y retire el dosel del marco principal (4).
3. Deslice hacia afuera el forro.
4. Deshaga las correas de sujeción (5) y retire la presa dura..
5. Limpie la cubierta principal con un paño húmedo.
6. Descomprima la cubierta del cojín, retire la esponja interior y lave la cubierta a mano con agua tibia.

LISTA DE EMPAQUE

N	Nombre de partes	Cantidad
1	Marco principal	1
2	Ruedas frontales	1
3	Componente del eje	1
4	Bandeja de la taza	1
5	Placa frontal	1
6	Cojín de esponja	1
7	Cesta inferior	1
8	Llanta trasera	2
9	Cubierta	2
10	Clip	2
11	Tornillo (4x12)	4
12	Instrucciones de uso	1

El cochecito para mascotas ha sido diseñado específicamente para llevar mascotas al veterinario y para mascotas de edad avanzada o nerviosas con problemas de movilidad o de cadera, en las excursiones. El cochecito es liviano y fácil de maniobrar



ADVERTENCIA:

Para la seguridad de su mascota, lea lo siguiente y guárdelo para futuras referencias.



Precaución

1. No levante el cochecito cuando la mascota esté en dentro.
2. Nunca use el cochecito en un lugar irregular.
3. Nunca use el cochecito cerca del fuego u otra área peligrosa.
4. Debe usar los frenos cuando deje de mover el cochecito.
5. No coloque dos o más de dos mascotas en el cochecito.
6. No guarde ni use este cochecito en áreas expuestas a altas o bajas temperaturas o humedad durante mucho tiempo.
7. Máximo peso de la mascota para este cochecito es 15KGS.

Einzelteile

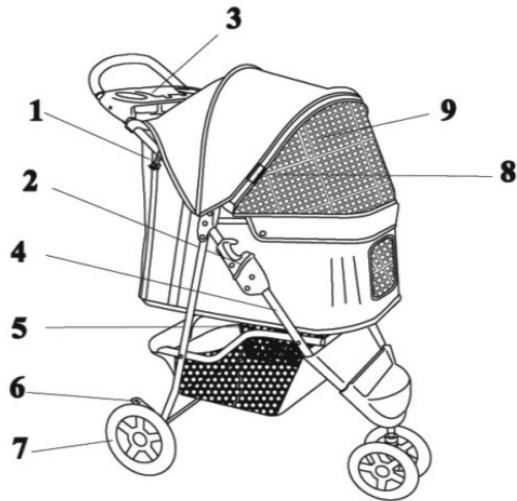

1. Sicherungsklammer
2. Seitenverschluss
3. Tassenhalter
4. Hauptrahmen
5. Befestigungsgurte
6. Bremsen
7. Reifen
8. Reißverschluss
9. Abdeckhaube

Zusammenbau des Wagens:

1. Lösen Sie die Sicherungsklammer(1) am Hauptrahmen (4).

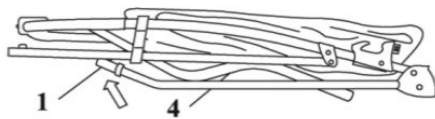

2. Klappen Sie den Buggy auf und rasten Sie die Seitenteile ein. Stellen Sie sicher, dass beide Seitensperren (2) richtig gesichert werden.

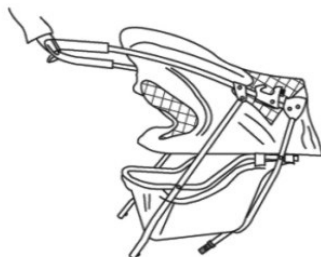

3. Führen Sie die Vorderräder in die dafür vorgesehenen Rohre im Hauptrahmen und Drücken Sie den Druckknopf. Schieben Sie die Vorderräder in die richtige Position bis der Druckknopf einrastet.



4. Schieben Sie die Hinterräder auf die Achse, dann setzen Sie die Unterlegscheibe auf die Achse und sichern diese mit dem Sicherheitsclip. Decken Sie nun das Rad mit der Abdeckung ab. Schieben Sie jetzt die Achse mit den montierten Rädern auf den Hauptrahmen bis die Feder einrastet.

(Zur Demontage: Drücken Sie die Feder am Hinterradrahmen und entfernen Sie die Vorrichtung).

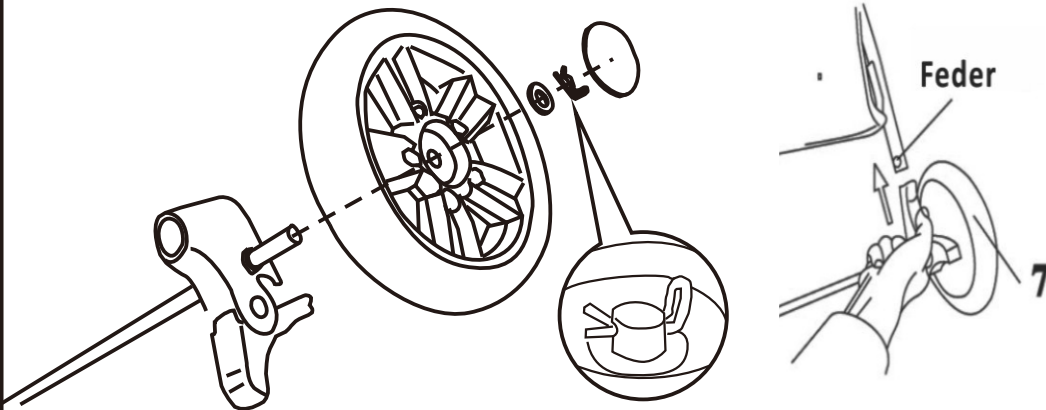

Fertig montiert sieht das so aus:

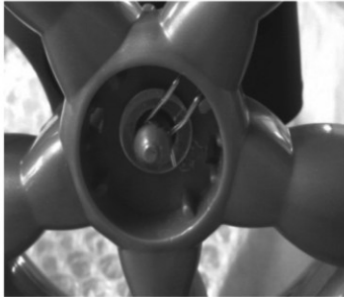

5. Der Reißverschluss am Korb sollte nach vorne gezogen werden.

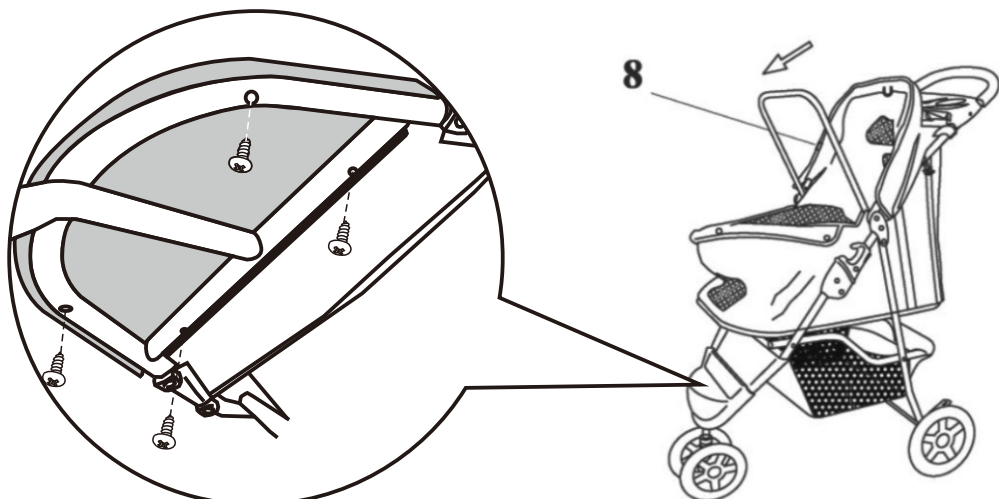

Bremsen

1 . Sichern Sie, zur Sicherheit Ihres Haustiers, den Buggy immer mit den Bremsen, wenn Sie ihn abstellen (6) .

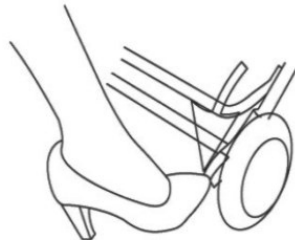

2 . Sie sperren die Hinterräder durch einfaches Herunterdrücken des Bremshebels auf beiden Seiten.

Zusammenklappen

- 1 . Öffnen Sie den Reißverschluss am Korb.
- 2 . Klappen Sie die Abdeckhaube hoch (3).
- 3 . Ziehen Sie an beiden Seitensperren (2).
- 4 . Klappen Sie den Haustierwagen zu.
- 5 . Befestigen Sie den Seitenverschluss (1).



Reinigung und Pflege

- 1 . Lösen Sie die Befestigungsgurte (5) unter dem Korb.
- 2 . Lösen Sie die sechs Schrauben von der Abdeckhaube und entfernen Sie diese vom Hauptrahmen (4).
- 3 . Entnehmen Sie die Innenverkleidung.
- 4 . Lösen Sie die Befestigungsgurte (5) und nehmen Sie den festen Boden raus.
- 5 . Wischen Sie die Abdeckung mit einem feuchten Tuch ab.
- 6 . Öffnen Sie den Kissenbezug mit dem Reißverschluss, nehmen Sie die Schaumstoffunterlage raus und waschen Sie diese von Hand mit lauwarmem Wasser.

Der Hundebuggy wurde speziell zum Transport von Haustieren zum Tierarzt und zur Beförderung von älteren oder nervösen Haustieren mit Hüft-oder allgemeinen Bewegungs-Problemen konzipiert.

Teileliste

Nummer	Einzelteil-Name	Menge
1	Hauptrahmen	1
2	Vorderräder	1
3	Achse	1
4	Tassenhalterung	1
5	Vorderblende	1
6	Schwammpolster	1
7	Unterkorb	1
8	Hinterreifen	2
9	Abdeckung	2
10	Sicherheitsclip	2
11	Schraube (4x12)	4
12	Gebrauchsanleitung	1

WARNUNG:

Für die Sicherheit Ihres Haustiers, lesen Sie bitte die folgenden Hinweise und halten Sie dieses Handbuch zum Nachschlagen bereit.



Vorsicht!

1. Heben Sie den Wagen nicht, wenn sich Ihr Haustier noch im Buggy befindet.
2. Verwenden Sie den Wagen niemals auf unebenen Flächen.
3. Verwenden Sie den Wagen niemals in der Nähe von Feuer oder anderen Gefahrenbereichen.
4. Sichern Sie den Buggy immer mit den Bremsen, wenn Sie ihn abstellen.
5. Dieser Wagen ist nur für den Transport eines Haustiers. Transportieren Sie niemals mehrere Tiere mit dem Buggy.
6. Lagern oder benutzen Sie diesen Wagen nicht für längere Zeit in Bereichen mit sehr hoher oder sehr niedriger Temperatur oder mit hoher Luftfeuchtigkeit.
7. Dieser Buggy ist für Haustiere mit einem Gewicht bis zu 15 kg ausgelegt.

Parti

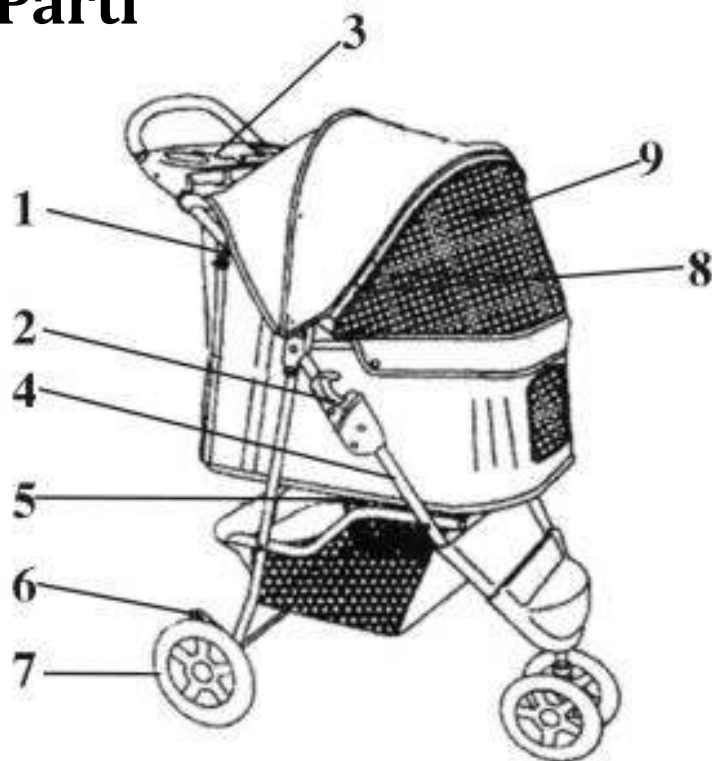

1. Sicura principale
2. Sicura laterale
3. Tavolino
4. Struttura principale
5. Cinghie di allacciamento
6. Freni
7. Ruote posteriori
8. Cerniera
9. Tendina

Per aprire

1. Sbloccare le sicure (1) dalla struttura principale (4)

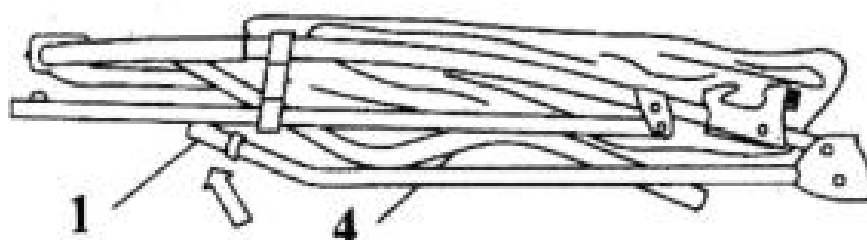

2. Aprire il passeggino per animali domestici e fissare in posizione. Assicurarsi che entrambe le sicure laterali (2) siano fissate in sicurezza

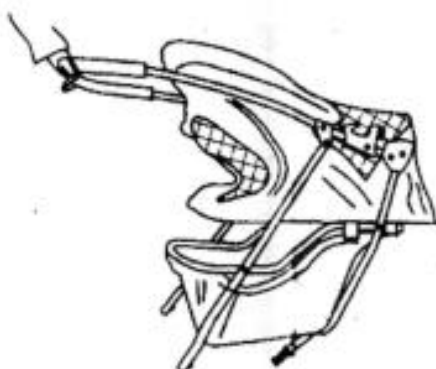

3. Inserire la montatura della ruota anteriore nel supporto frontale fino a che la leva di bloccaggio non scatti e fuoriesca.

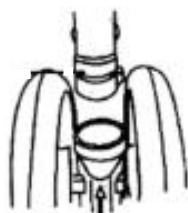

4. Spingere le ruote posteriori, la guarnizione, la clip, e la montatura della protezione nell'asse. Poi premere e inserirlo nella struttura principale fino a che i perni corrispondenti non scattino e fuoriescano.

(Per smontare: premere la molla della ruota posteriore e rimuovere la montatura.)

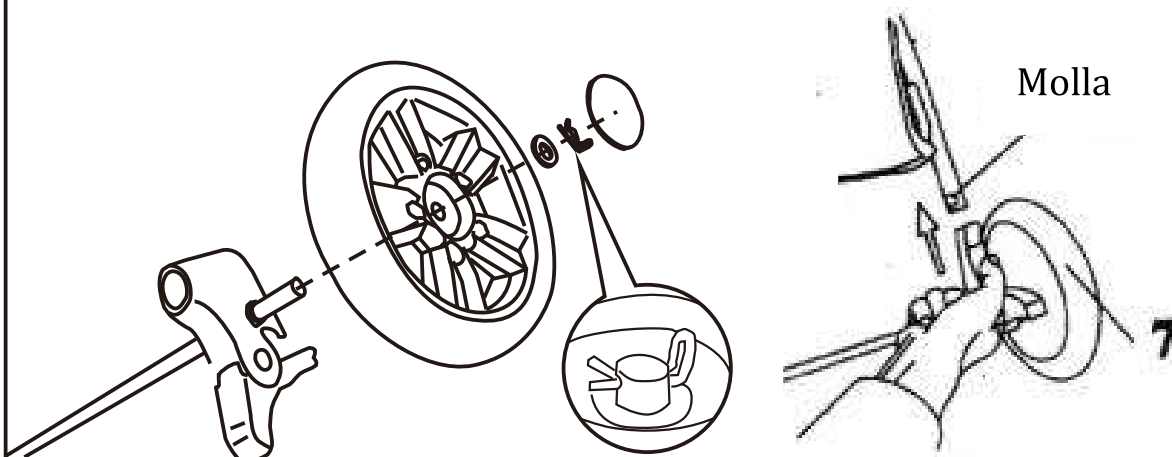

5. La cerniera del cesto deve essere chiusa fino a portarla alla parte frontale.

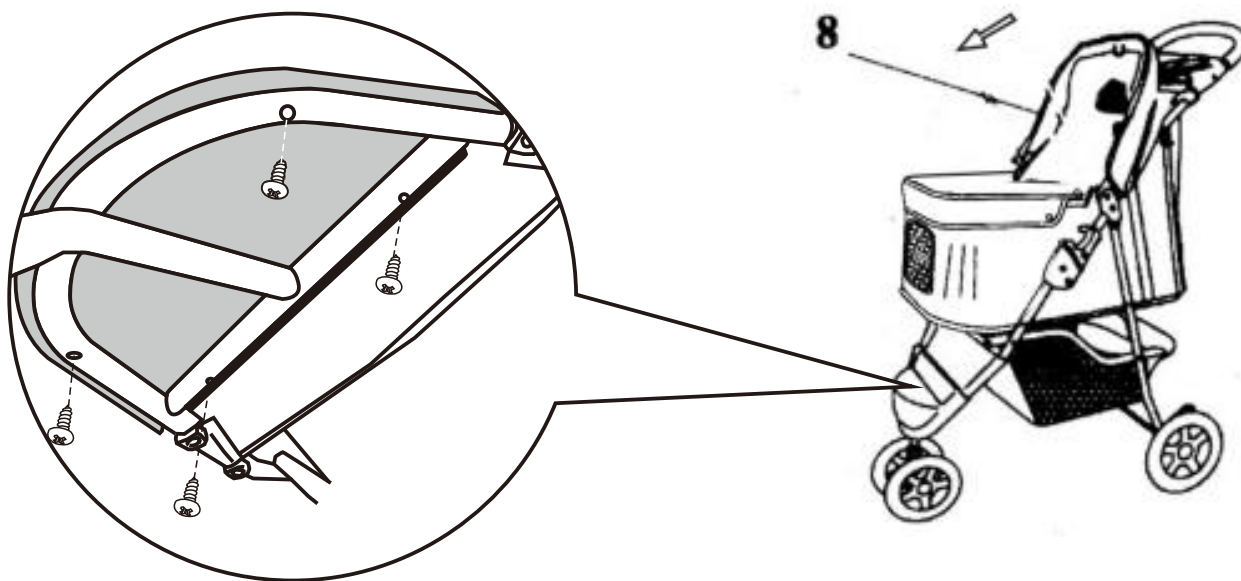

Freni

1. Per la sicurezza del vostro animale domestico, attivare sempre i freni (6) quando il passeggino non è in moto.



2. Bloccare le ruote posteriori semplicemente spingendo verso il basso le leve dei freni su entrambi i lati.

Per ripiegare

1. Slacciare la cerniera del cesto.
2. Alzare i supporti della tendina (3).
3. Alzare entrambe le sicure laterali(2).
4. Ripiegare il passeggino.
5. Bloccare le sicure laterali (1).



Pulizia e manutenzione

1. Disfare le cinghie (5) sotto al cesto.
2. Svitare le sei viti del support tendina e rimuoverla dalla struttura principale (4).
3. Abbassare il telo.
4. Disfare le cinghie (5) e rimuovere la base.
5. Pulire la protezione principale passando uno straccio umido.
6. Slacciare la protezione del cuscino, rimuovere la spugnainterna e lavare a mano la fodera in acqua tiepida.

PACKING LIST

No.	NOME PARTE	QTY.
1	Struttura principale	1
2	Ruote frontali	1
3	Componente asse	1
4	Tavolino	1
5	Placca frontale	1
6	Cuscino di spugna	1
7	Cesto inferior	1
8	Ruota posterior	2
9	Protezione	2
10	Clip	2
11	Viti (4x12)	4
12	Istruzioni d'uso	1

Il passeggino è stato pensato appositamente per portare gli animali domestici dal veterinario o per portare a passeggio animali ansiosi o con problemi di mobilità. Il passeggino è leggero e facile da operare



ATTENZIONE

Per la sicurezza del vostro animale domestico, si prega di leggere e conservare le seguenti istruzioni.



Avvertenze

1. Non sollevare il passeggino quando l'animale vi è dentro.
2. Non usare mai il passeggino su superfici inclinate.
3. Non usare mai il passeggino vicino al fuoco o vicino ad aree pericolose.
4. Usare sempre i freni quando arrestate il passeggino.
5. Non posizionare due o più animali nel passeggino.
6. Non conservare o usare questo passeggino in aree esposte ad alte o basse temperature o ad umidità per lunghi periodi.
7. Peso massimo per questo passeggino 15kgs.

If you have any questions, please contact our customer care center, Our contact details are below:

US

 001-877-644-9366

 customerservice@aosom.com

Imported by Aosom LLC
27150 SW Kinsman Rd Wilsonville, OR 97070 USA
MADE IN CHINA

Wenn Sie Fragen haben, wenden Sie sich bitte an unser Kundendienstzentrum, Unsere Kontaktdaten stehen unten:

DE

 0049-0(40)-88307530

 service@aosom.de

ADRESSE DES IMPORTEURE/Hersteller/REP:
MH Handel GmbH
Wendenstraße 309
D-20537 Hamburg
Germany
IN CHINA HERGESTELLT

If you have any questions, please contact our customer care center, Our contact details are below:

CA

 416-792-6088

 customerservice@aosom.ca

Imported by Aosom Canada Inc.
7270 Woodbine Avenue, Unit 307, Markham,
Ontario Canada L3R 4B9
MADE IN CHINA

Si vous avez la moindre question, veuillez contacter notre centre d'assistance à la clientèle, Nos coordonnées sont les suivantes:

 416-792-6088

 customerservice@aosom.ca

Importé par Aosom Canada Inc.
7270 Woodbine Avenue, unité 307,
Markham, Ontario Canada L3R 4B9
FABRIQUÉ EN CHINE

In caso di dubbio, si prega di contattare il nostro centro assistenza clienti, I nostri dettagli di contatto sono di seguito:

IT

 0039-0249471447

 clienti@aosom.it

IMPORTATO DA/Produttore/REP:
AOSOM Italy srl
Centro Direzionale Milanofiori
Strada 1 Palazzo F1
20057 Assago (MI)
P.I.: 08567220960
FATTO IN CINA

Si tiene alguna pregunta, comuníquese con nuestro Centro de Atención al Cliente, Nuestros datos de contacto son los siguientes:

ES

 0034-931294512

 atencioncliente@aosom.es

IMPORTADOR/Fabricante/REP:
SPANISH AOSOM, S.L.
C/ROC GROS, N°15.08550, ELS HOSTALETES DE
BALENYÀ, SPAIN.
B66295775
HECHO EN CHINA

If you have any questions, please contact our customer care center, Our contact details are below:

UK

 0044-800-240-4004

 enquiries@mhstar.co.uk

IMPORTER ADDRESS:
MH STAR UK LTD
Unit 27, Perivale Park,
Horsenden lane South
Perivale, UB6 7RH
MADE IN CHINA

Se tiver alguma dúvida, por favor contacte o nosso Centro de Atendimento ao Cliente, Os nossos dados de contacto são os seguintes:

PT

 0034-931294512

 info@aosom.pt.

IMPORTADOR/Fabricante/REP:
SPANISH AOSOM, S.L.
C.ROC GROS N.15, 08550. ELS HOSTALETES DE
BALENYÀ
FEITO NA CHINA

Si vous avez la moindre question, veuillez contacter notre centre d'assistance à la clientèle, Nos coordonnées sont les suivantes:

FR

 0033-1-84166106

 aosom@mhfrance.fr

Importé par/Fabricant/REP:
MH FRANCE
2 Rue Maurice Hartmann
92130 Issy Les Moulineaux
France
FABRIQUÉ EN CHINE



FR

**DONNEZ
OU
RECYCLEZ**



ASSOCIATION

OU



LIVRAISON

OU



DÉCHÈTERIE

Adresses sur quefairedemesdechets.fr