

HOMCOM

INaj039V01_UK_DE_FR_ES_IT

A70-051

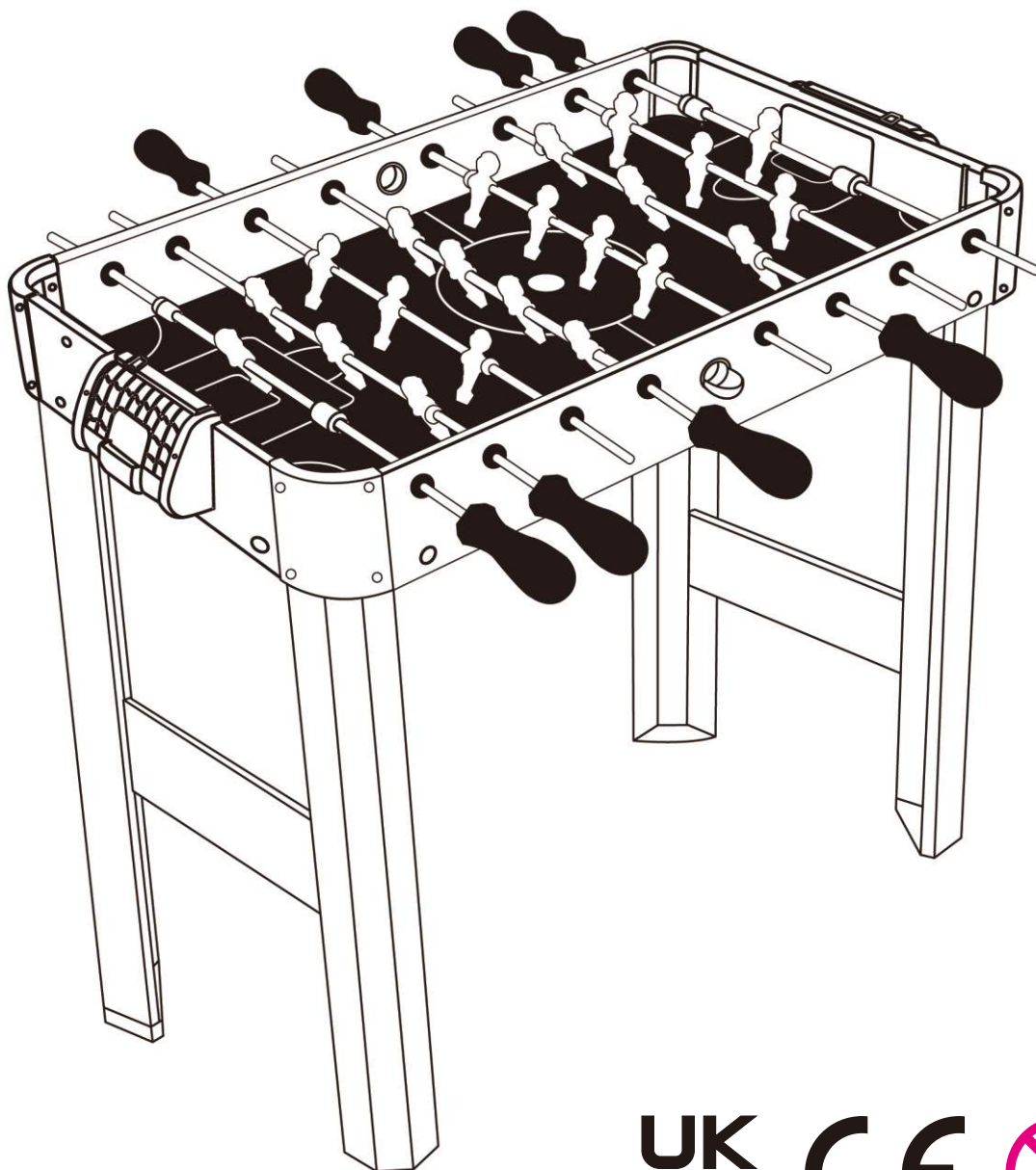

UK
CA

CE



EN_IMPORTANT, RETAIN FOR FUTURE REFERENCE: READ CAREFULLY.

**FR_IMPORTANT: A LIRE ATTENTIVEMENT ET À CONSERVER POUR CONSULTATION
ULTÉRIÈRE.**

ES_IMPORTANTE, LEA Y GUARDE PARA FUTURAS REFERENCIAS.

DE_WICHTIG! SORGFÄLTIG LESEN UND FÜR SPÄTER NACHSCHLAGEN AUFBEWAHREN.

**IT_IMPORTANTE! CONSERVARE IL PRESENTE MANUALE PER FUTURO RIFERIMENTO E
LEggerlo ATTENTAMENTE.**

 **WARNING:**

CHOKING HAZARD-Small parts.

Not for children under 14 years.

CAUTIONS:Must assure the product is correctly assembled according to the instruction before use.(Assembly tools are included in the box)

The process of assembly must done by an adult or under direction of an adult.

 **Advertencia:**

Riesgo de asfixia - No es para niños menores de 14 años.

Precaución: Debe asegurarse que el producto se ensambla correctamente según las instrucciones antes de usar. Las herramientas de montaje están incluidas en la caja. El proceso de montaje debe ser realizado por un adulto o bajo la dirección de un adulto.

 **ATTENTION:**

RISQUE D'ETOUFFEMENT – Petites pièces.

Pas pour les enfants de moins de 14 ans.

ATTENTION: Assurez-vous que le produit soit correctement assemblé selon les instructions avant l'utilisation. (Les outils d'assemblage sont dans la boîte). Le processus d'assemblage doit être fait par un adulte ou sous la direction d'un adulte.

 **AVVERTIMENTO:**

PERICOLO DI SOFFOCAMENTO a causa di piccole parti.

Non per bambini sotto i 14 anni.













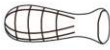

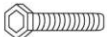

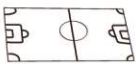
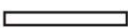

ATTENZIONE: Assicurarsi che il prodotto sia correttamente assemblato in accordo con le istruzioni prima dell'uso (gli strumenti per l'assemblaggio sono inclusi nella scatola). Il processo d'assemblaggio dev'essere seguito da un adulto o sotto la supervisione di un adulto.

 **WARNUNG:**

Erstickungsgefahr - Kleinteile.

Nicht für Kinder unter 14 Jahren.

VORSICHT: Stellen Sie bitte vor dem Gebrauch sicher, dass das Produkt nach der Aufbauanleitung richtig montiert ist.(Die Montagewerkzeuge sind im Lieferumfang enthalten.)Erwachsene Montage erforderlich.

Number		Qty	Number		Qty
A1		4 PZ	A2		2PZ
A3		4 PZ	A4		8PZ
A5	 5MMx10mm	20 PZ	A6	 3MMx10mm	8 PZ
A7	 5MMx25mm	16 PZ	A8	 3.5MMx25mm	4 PZ
A9		2 PZ	A10		1 PZ
B1		2PZ	B2		2 PZ
B3		1 PZ	B4		2 PZ
B5		4 PZ	B6		2 PZ
C1		1 PZ	D1		1 PZ
C2		2 PZ	D2		2 PZ
C3		1 PZ	D3		1 PZ

