

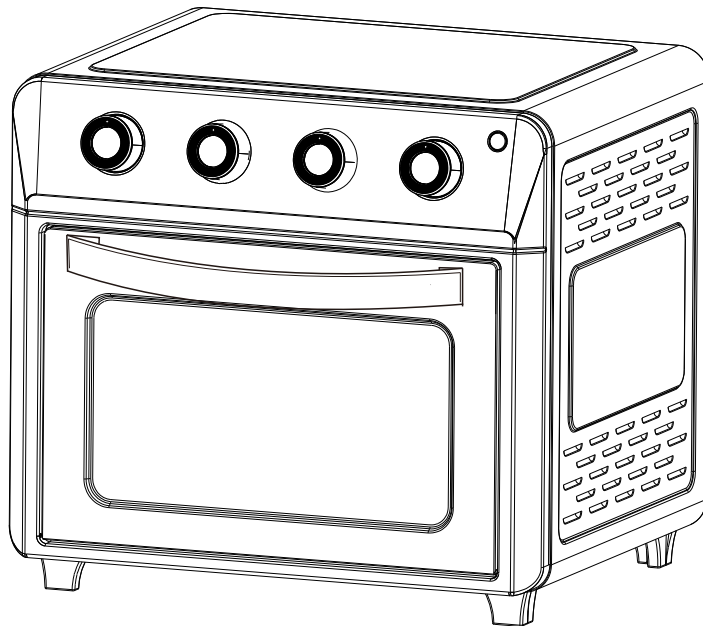

IN240600065V01_UK

800-203V70



AC 220-240V 50Hz 1600W



EN_IMPORTANT, RETAIN FOR FUTURE REFERENCE: READ CAREFULLY.

FR_IMPORTANT: A LIRE ATTENTIVEMENT ET À CONSERVER POUR CONSULTATION ULTÉRIEURE.

ES_IMPORTANTE, LEA Y GUARDE PARA FUTURAS REFERENCIAS.

PT_IMPORTANTE, RETER PARA REFERÊNCIA FUTURA: LEIA ATENTAMENTE.

DE_WICHTIG! SORGFÄLTIG LESEN UND FÜR SPÄTER NACHSCHLAGEN AUFBEWAHREN.

IT_IMPORTANTE! CONSERVARE IL PRESENTE MANUALE PER FUTURO RIFERIMENTO E LEGGERLO ATTENTAMENTE.

IMPORTANT SAFEGUARDS

1. Read all instructions.
2. When not in use and before cleaning, unplug the appliance and wait for it to cool down.
3. Do not touch hot surfaces - use handles or knobs.
4. To prevent electric shock, do not submerge the appliance, its cord or plug into water or other liquid.
5. Small children must not use this appliance.
6. If the appliance, its cord or plug is damaged or the appliance malfunctions in any way, do not use it. Return the appliance to the place of purchase for examination, repair or adjustment.
7. Accessories, which are not manufacturer-recommended, can cause damage or injury.
8. Do not use outdoors.
9. Do not allow the cord to hang over the edges of tables or countertops, where it could be tripped on. Keep the cord away from hot surfaces to avoid damage.
10. Keep this appliance away from hot gas, electric burners, heated ovens and other heated sources.
11. Do not use the appliance for anything other than its intended purpose.
12. If using containers that are NOT made from metal or glass, extreme caution must be taken.
13. To prevent burns, be cautious when removing items from the appliance and disposing of hot grease.
14. When not in use, always unplug the appliance. Materials, which are not manufacturer-recommended accessories, must not be stored in the appliance.
15. Do not place any of the following materials in the appliance: paper, cardboard, plastic or anything similar.
16. Do not cover the appliance, crumb tray or any other part with metal foil. This will cause the oven to overheat.
17. To prevent the risk of fire or electric shock, do not place oversized food, metal foil packages and utensils inside this appliance.
18. Keep the appliance away from curtains, draperies, walls and other flammable materials. Do not store any items on top of the appliance. Do not operate under wall cabinets.
19. Do not clean this appliance with metal scouring pads. Pieces can break off and touch electrical parts, increasing the risk of an electrical shock.
20. Whilst plugged in, do not attempt to remove food from the appliance.
21. Whilst in use, never leave the appliance unattended.
22. Keep the appliance away from walls and other appliances. Ensure there are at least four inches of space on the back, sides and above the appliance, allowing air to circulate properly.
23. Never place utensils, baking trays or any other items on the glass door.
24. To disconnect, turn all controls to the 'OFF' position, then remove the plug from the wall outlet.
25. When in use, keep the appliance out of the reach of children.
26.  This symbol means: Caution, hot surface!

PRODUCT STRUCTURE:

- A. Door handle
- B. Door frame
- C. Door glass
- D. Door hook
- E. Heating elements
- F. Door seal
- G. Air Fry temperature knob
- H. Heating mode knob
- I. Oven temperature knob
- J. Timer knob
- K. Power indicator light
- L. Housing
- M. Cooling hole
- N. Oven foot
- O. Bake tray
- P. Crumb tray
- Q. Bake rack
- R. Frying basket
- S. Tray handle

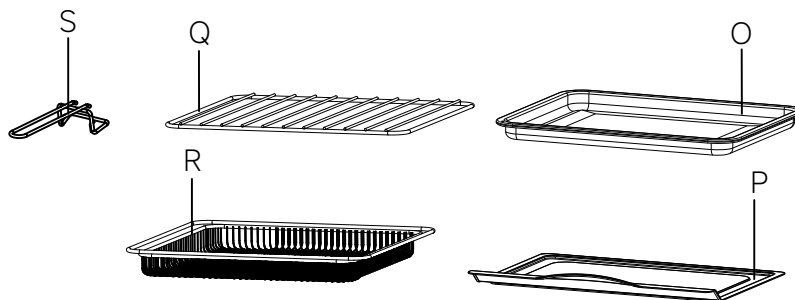
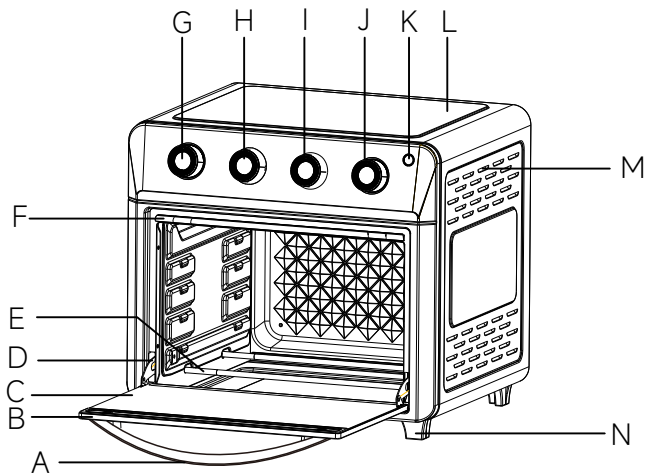

KNOB INSTRUCTIONS:

Air Fry:

- Turn the 'Function' knob to 'Air Fry'.
- Turn the 'Air Fry Temperature' knob to 230°C or less.
- Turn the 'Oven Timer' knob to the desired cooking time – the appliance will begin air frying.
- The power light will be on.
- Once the cycle is complete, the timer will ring and the appliance will turn off automatically.
- To stop air frying, turn the 'Oven Timer' knob to the 'OFF' position.
- At the 'Air Fry' mode, the bottom two heating tubes and upper middle two heating tubes with the top fan work together.

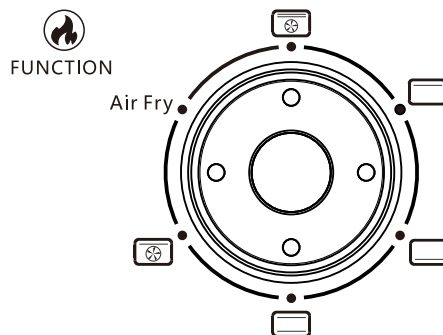

- Turn the 'Function' knob to 'Broil'.
- Turn the 'Air Fry Temperature' knob to 230°C or less.
- Turn the 'Oven Timer' knob to the desired cooking time – the appliance will begin broiling.
- The power light will be on.
- Once the cycle is complete, the timer will ring and the appliance will turn off automatically.
- To stop mode, turn the 'Oven Timer' knob to the 'OFF' position.
- At this mode, the upper two heating tubes with top fan work together, the upper middle two tubes and bottom two tubes will not work.



- Turn the 'Function' knob to '  '
- Turn the 'Air Fry Temperature' knob to 230°C or less.
- Turn the 'Oven Timer' knob to the desired cooking time – the appliance will begin broiling.
- The power light will be on.
- Once the cycle is complete, the timer will ring and the appliance will turn off automatically.
- To stop mode, turn the 'Oven Timer' knob to the 'OFF' position.
- At this mode, the upper four heating tubes with top fan work together, the bottom two tubes will not work.



- Turn the 'Function' knob to '  ':
 - Turn the 'Oven Temperature' knob to 230°C or less.
 - Turn the 'Timer' knob to the desired cooking time – the oven will begin baking.
 - Before cooking, it is recommended to preheat the oven for five minutes.
 - The power light will be on.
 - Once the cycle is complete, the timer will ring and the appliance will turn off automatically.
 - To stop mode, turn the 'Oven Timer' knob to the 'OFF' position.
 - At this mode, the upper two heating tubes work only, the upper middle two tubes will not work.



- Turn the 'Function' knob to '  ':
 - Turn the 'Oven Temperature' knob to 230°C or less.
 - Turn the 'Timer' knob to the desired cooking time – the oven will begin baking.
 - Before cooking, it is recommended to preheat the oven for five minutes.
 - The power light will be on.
 - Once the cycle is complete, the timer will ring and the appliance will turn off automatically.
 - To stop mode, turn the 'Oven Timer' knob to the 'OFF' position.
 - At this mode, the bottom two heating tubes work only.
 - At this mode, you can turn the 'Oven Temperature' to the 'Warm' position, then keep warm you want.



- Turn the 'Function' knob to '  ':
 - Turn the 'Oven Temperature' knob to 230°C or less.
 - Turn the 'Oven Timer' knob to the desired toasting time – the appliance will begin toasting.
 - The power light will be on.
 - Once the cycle is complete, the timer will ring and the appliance will turn off automatically.
 - To stop mode, turn the 'Oven Timer' to the 'OFF' position.
 - At this mode, the upper two heating tubes and bottom two heating tubes will work together, the upper middle two tubes will not work.

AIR FRY TEMPERATURE SETTING

To set the desired temperature (90-230 °C), turn the 'Temperature' knob clockwise. To switch it off, turn the knob to the 'OFF' position.

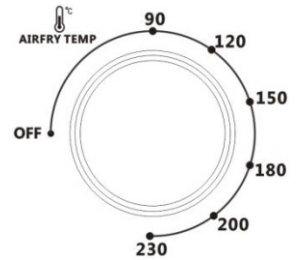

OVEN TEMPERATURE SETTING

To set the desired temperature (OFF-Warm to 230 °C), turn the 'Temperature' knob clockwise.

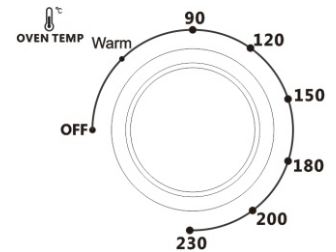

Notice: there with $\pm 30^{\circ}\text{C}$ temperature difference, it is normal

TIME SETTING

- Set the timer for up to 60 minutes.
- The oven requires the timer to be set for operation.
- To set the time, turn the 'Timer' knob clockwise to your desired duration.
- The indicator light will be on when the time has been set.
- When the timer reaches the 'OFF' position, you will hear a bell sound – the appliance will turn off automatically.

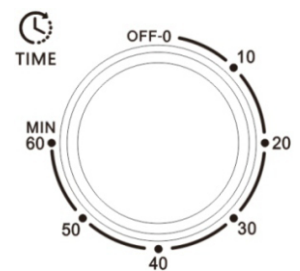

ADJUSTING TIME

The timer can be changed during the cooking cycle. Just turn the 'Timer' knob to the desired time and continue cooking.

NOTE: To select the cooking time, first rotate the 'Timer' knob past the 10-minute mark, then switch it back to the time you require.

BEFORE USING FOR THE FIRST TIME

- (1) Remove all packaging labels and stickers from the oven.
- (2) Clean all accessories with water and washing-up liquid, using a non-abrasive sponge. Ensure all accessories are dry before use.
- (3) Place the crumb tray at the bottom of the appliance. Do not place anything on top of this appliance.
- (4) Place the appliance on a flat surface. Before using, ensure there are at least four inches of space between all sides of the appliance and other objects. Do not use on heat-sensitive surfaces.
- (5) There may be excess water on the countertop, as water will release from food during cooking.
 - a. During first-time use, the oven may emit smoke. This is normal and will disappear after five minutes. We recommend pre-heat the oven with open the door for 5-10 minutes.
 - b. Whilst the oven is in use, steam will release from the oven body. This is normal and not a cause for concern.



CLEANING AND MAINTENANCE:

Warning: Never immerse the cord, the plug or the oven in water or other liquid. Never touch, operate or plug in the appliance with wet hands.

- (1) For optimal performance, clean the appliance after each use. Removing the grease will keep your appliance consistent.
- (2) Before cleaning, unplug the appliance and wait for it to cool down.
- (3) When cleaning this appliance, never use abrasive cleaners or corrosive products. This will damage the oven surface and cause rust.
- (4) Clean the outside of the appliance with a soapy sponge, towel or cloth. Do not apply a cleaning agent directly onto the oven.
- (5) To clean the inside of the appliance, use a damp cloth and a mild liquid soap or spray solution on a sponge/towel. Remove all residue after each use. Never use steel wool pads or harsh abrasives and corrosive products.
- (6) Hand-wash accessories in warm water. You can also use a nylon scouring pad or nylon brush. Or put them into the dishwashers.
- (7) After each use, make sure all the inside walls complete dry.

TROUBLESHOOTING



Problem	Solution
The appliance does not work.	<ol style="list-style-type: none"> 1. Ensure the oven is plugged into a dedicated power outlet. 2. Turn the 'TIMER' knob to a set time. 3. Select one heating mode and set the temperature
Food is not cooked.	<ol style="list-style-type: none"> 1. Use smaller batches for more even cooking. 2. Raise the temperature and continue cooking.
Food is not fried evenly.	<ol style="list-style-type: none"> 1. Turn over food halfway through the cooking process. 2. Cook similar-sized foods together.
White smoke is coming out of the appliance.	<ol style="list-style-type: none"> 1. Clean the appliance and its accessories after every use, removing any greasy residue. 2. Do not bake for too long. 3. Use the baking tray to catch cooked oil during cooking.
French fries are not cooked evenly.	<ol style="list-style-type: none"> 1. Fry fewer potatoes at a time. 2. Blanch potatoes with boiling water before frying. 3. Use firm and fresh potatoes and cut them into sticks.
Fries are not crispy.	<ol style="list-style-type: none"> 1. Remove excess water from potatoes. 2. Cut potatoes into more narrow strips. 3. Mix with a little oil.
Food is burnt	<ol style="list-style-type: none"> 1. Do not bake for too long. It is recommended to preheat the appliance for 5-10 minutes. 2. Make sure the food does not touch the heating tubes.



If you have any questions, please contact our customer care center. **US**
Our contact details are below:
 001-877-644-9366
 customerservice@aosom.com
Imported by Aosom LLC
27150 SW Kinsman Rd Wilsonville, OR 97070 USA
MADE IN CHINA

Si tiene alguna pregunta, comuníquese con nuestro Centro de Atención al Cliente. **ES**
Nuestros datos de contacto son los siguientes:
 0034-931294512
 atencioncliente@aosom.es
IMPORTADOR:
SPANISH AOSOM, S.L.
C/ ROC GROS, Nº 15. 08550, ELS HOSTALETES DE BALENYÀ, SPAIN.
B66295775
WWW.AOSOM.ES
HECHO EN CHINA



If you have any questions, please contact our customer care center. **CA**
Our contact details are below:
 416-792-6088
 customerservice@aosom.ca
Imported by Aosom Canada Inc.
7270 Woodbine Avenue, Unit 307, Markham, Ontario Canada L3R 4B9
MADE IN CHINA



Si vous avez la moindre question, veuillez contacter notre centre d'assistance à la clientèle.
Nos coordonnées sont les suivantes:



 416-792-6088
 customerservice@aosom.ca
Importé par Aosom Canada Inc.
7270 Woodbine Avenue, unité 307, Markham, Ontario Canada L3R 4B9
Fabriqué en Chine

Se tiver alguma dúvida, por favor contacte o nosso Centro de Atendimento ao Cliente. **PT**
Os nossos dados de contacto são os seguintes:
 0034-931294512 (SEG-SEX DAS 7:30H ÀS 16:30H)
 info@aosom.pt.
IMPORTADOR:
SPANISH AOSOM, S.L
C.ROC GROS N.15, 08550. ELS HOSTALETES DE BALENYÀ
WWW.AOSOM.PT

Wenn Sie Fragen haben, wenden Sie sich bitte an unser Kundendienstzentrum. **DE**
Unsere Kontaktdaten stehen unten:
 0049-0(40)-88307530  service@aosom.de
ADRESSE DES IMPORTEUR:
MH Handel GmbH
Wendenstraße 309
D-20537 Hamburg
Germany
IN CHINA HERGESTELLT

In caso di dubbio, si prega di contattare il nostro centro assistenza clienti. **IT**
I nostri dettagli di contatto sono di seguito:
 0039-0249471447  clienti@aosom.it
IMPORTATO DA:
AOSOM Italy srl
Centro Direzionale Milanofiori
Strada 1 Palazzo F1
20057 Assago (MI)
P.I.: 08567220960
FATTO IN CINA

If you have any questions, please contact our customer care center. **UK**
Our contact details are below:
 0044-800-240-4004
 enquiries@mhstar.co.uk
IMPORTER ADDRESS:
MH STAR UK LTD
Unit 27, Perivale Park,
Horsenden lane South
Perivale, UB6 7RH
MADE IN CHINA

Si vous avez la moindre question, veuillez contacter notre centre d'assistance à la clientèle. **FR**
Nos coordonnées sont les suivantes:
 0033-1-84166106
 aosom@mhfrance.fr
Importé par:
MH France
2, rue Maurice Hartmann
92130 Issy-les-Moulineaux
France
Fabriqué en Chine