

PawHut

INdhd001_GL

D30-296V02_D30-296V82

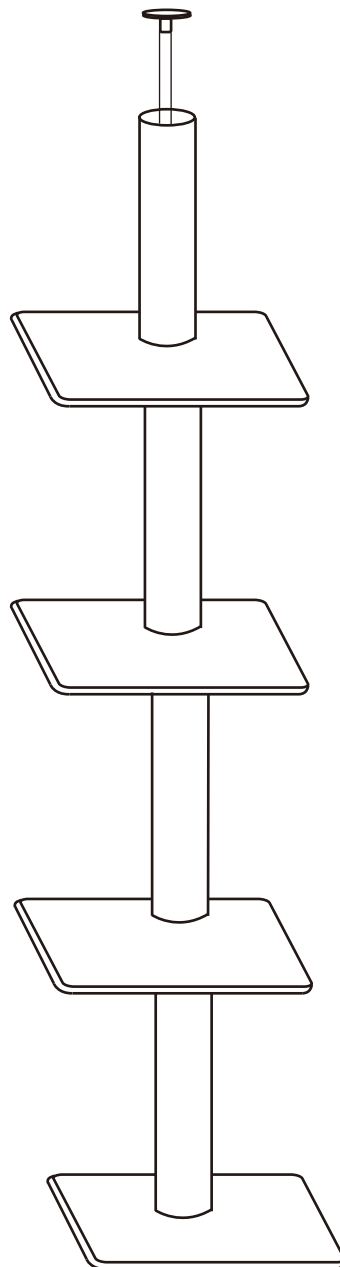

IMPORTANT, RETAIN FOR FUTURE REFERENCE: READ CAREFULLY

ASSEMBLY & INSTRUCTION MANUAL

PARTS

A x 1

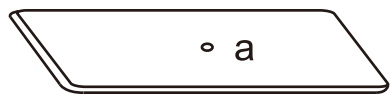

43*27*1.5mm

B x 3

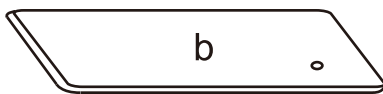

43*27*1.5mm

C x 3



9*55mm

D x 1

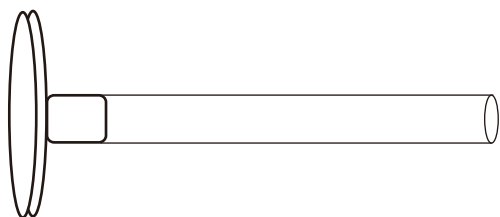

E x 1

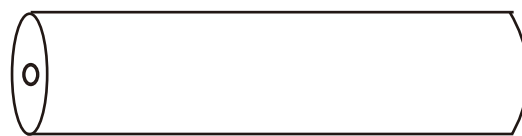

9*55mm

HARDWARE

F x 1
M10*40

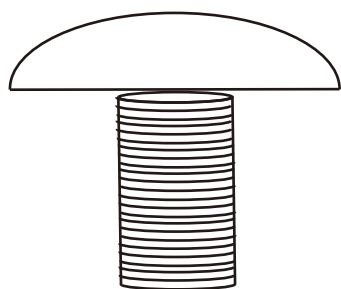

G x 3
M10*85

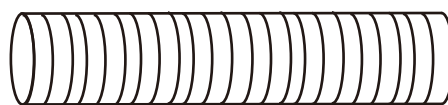

H x 1
M10*30



I x 1
M5

