

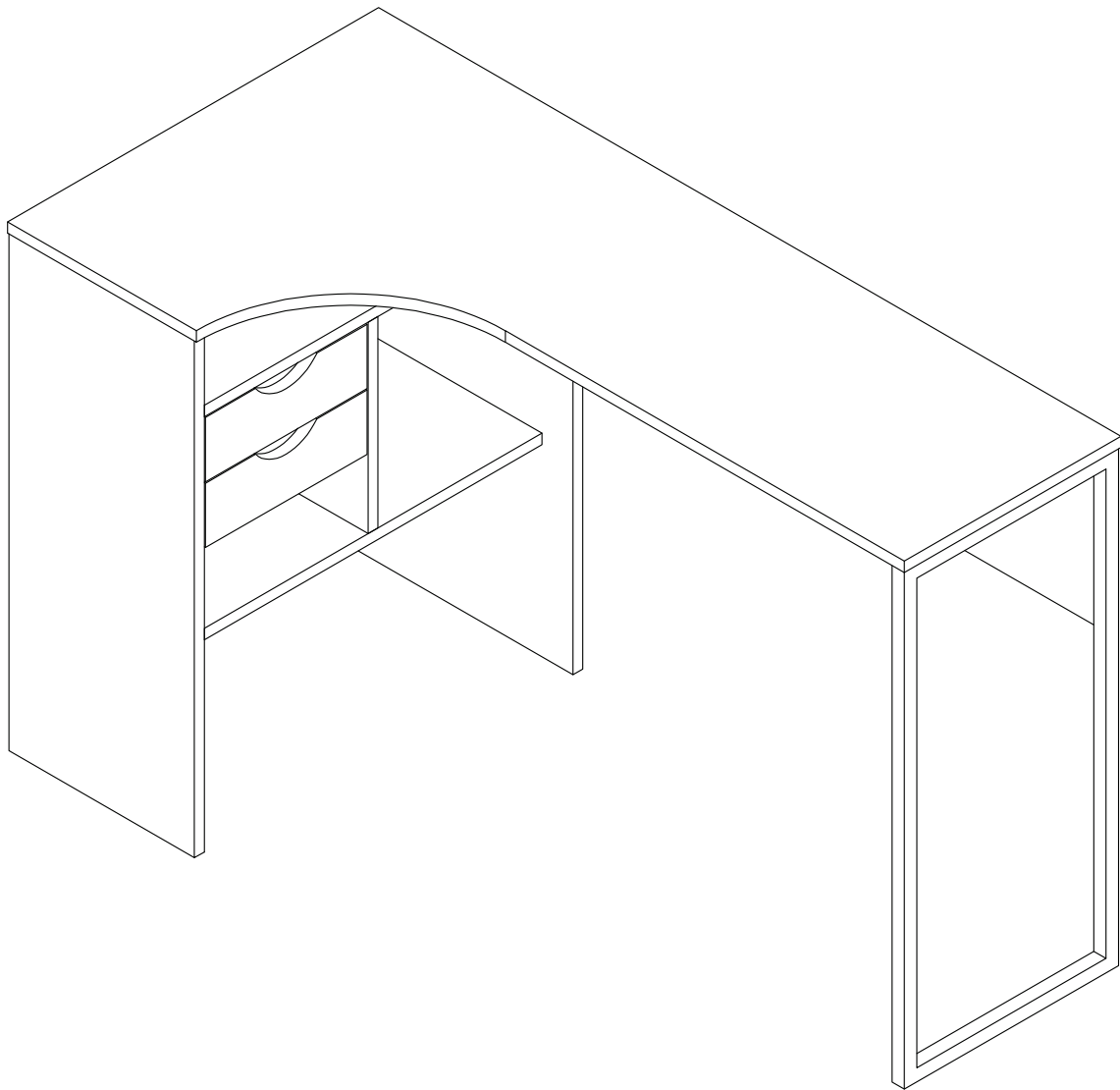

INc3b012V01_GL

836-435



IMPORTANT, RETAIN FOR FUTURE REFERENCE: READ CAREFULLY

ASSEMBLY & INSTRUCTION MANUAL

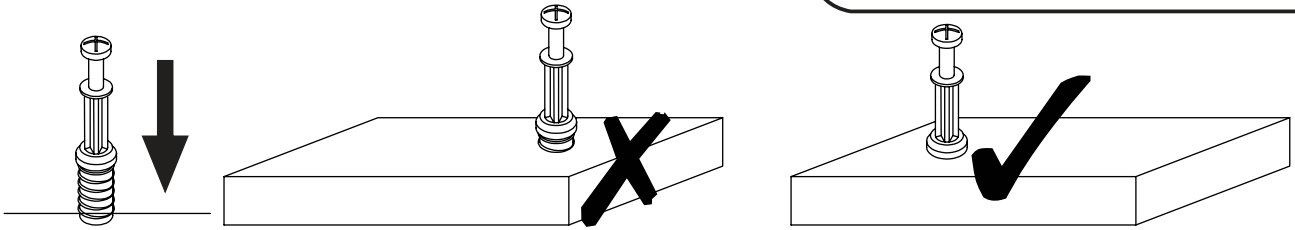

EN_QUICKFIT: Tighten quickfit until shoulder is flush with panel. Do not overtighten or undertighten.

FR_RACCORD RAPIDE: Faites serrer le raccord rapide jusqu'à ce que l'épaulement soit parfaitement encastré dans le panneau. Il ne faut ni trop serrer ni insuffisamment serrer.

ES_QUICKFIT: Apriete quickfit hasta que el hombro se descargue con el panel. NO lo sobreapriete ni lo apriete poco.

DE_QUICKFIT: Ziehen Sie den Quickfit fest, bis die Schulter mit der Platte bündig ist. Bitte nicht zu fest oder zu schwach anziehen.

IT_MONTAGGIO RAPIDO: Stringere il montaggio rapido fino a quando la spalla è a filo con il pannello, non stringere troppo o troppo poco.

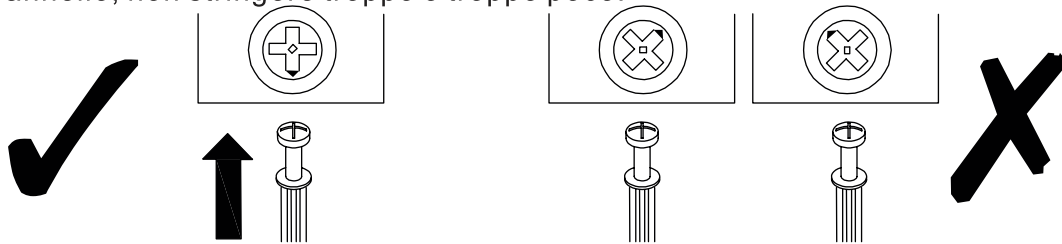

EN_CAM LOCK: When fitting cam lock, ensure starting position is correct before you insert connecting quickfit.

FR_SERRURE BATTEUSE: Avant d'insérer la serrure batteuse, veillez à la bonne orientation avant d'insérer le raccord rapide.

ES_CIERRE DE LA CÁMARA: Cuando instale el cierre de la cámara, asegúrese de que la posición de inicio es correcta antes de que inserte el quickfit conector.

DE_CAM-LOCK: Achten Sie bei der Montage des Cam-Locks auf die richtige Ausgangsposition, bevor Sie den Quickfit einsetzen.

IT_BLOCCAGGIO A CAMMA: Quando si monta il bloccaggio a camma, assicurarsi che la posizione iniziale sia corretta prima di inserire il montaggio rapido di collegamento.

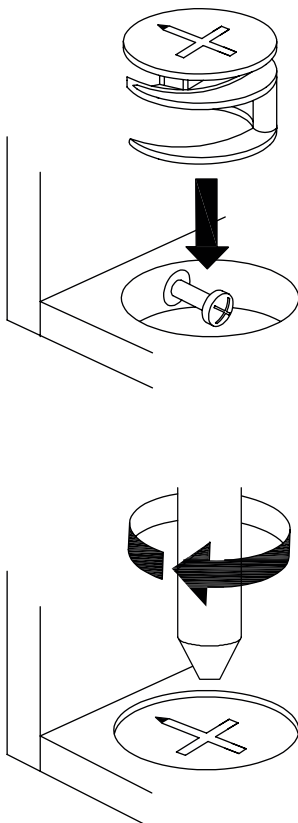

EN_Quickfit head should be in the centre of the cam lock when the two panels are joined.

Cam lock should be inserted before quickfit.

FR_Lorsque les deux panneaux sont assemblés, la tête du raccord rapide doit reposer au centre de la serrure batteuse.

Il faut insérer la serrure batteuse avant le raccord rapide.

ES_El cabezal del quickfit debe estar en el centro del cierre de la cámara cuando se unan los dos paneles.

Se debe insertar el cierre de la cámara antes que el quickfit.

DE_Der Quickfit-Kopf sollte sich in der Mitte des Cam-Locks befinden, wenn die beiden Platten zusammengefügt sind.

Der Cam-Lock sollte vor dem Quickfit eingesetzt werden.

IT_La testa del montaggio rapido deve trovarsi al centro del bloccaggio a camma quando i due pannelli sono uniti.

Il Bloccaggio a Camma deve essere inserito prima del montaggio rapido.

EN_Turn cam lock clockwise to tighten.





FR_Faites tourner la serrure batteuse dans le sens des aiguilles d'une montre pour la resserrer.

ES_Gire el cierre de la cámara en sentido horario para apretarlo.

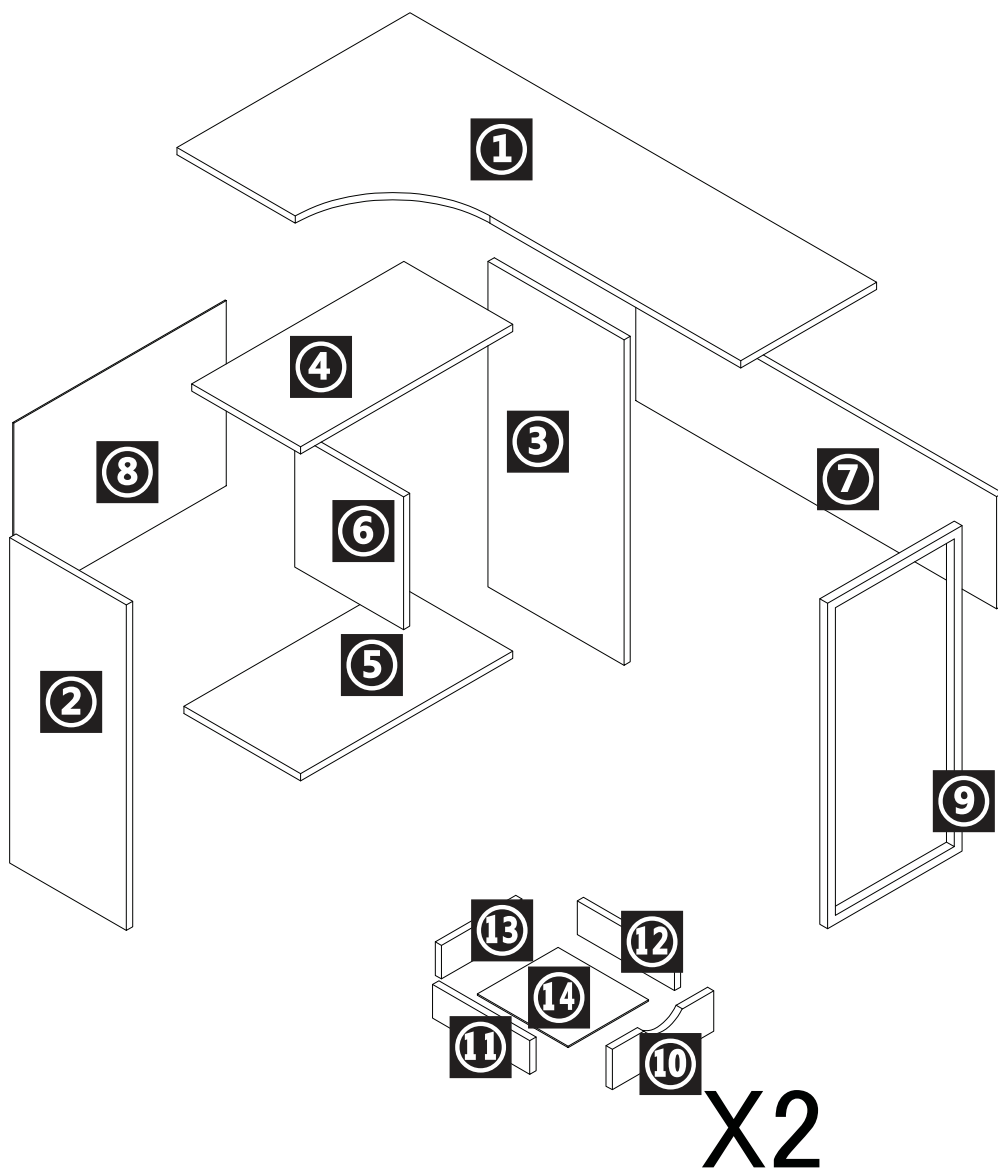
DE_Drehen Sie den Cam-Lock im Uhrzeigersinn, um ihn festzuziehen.

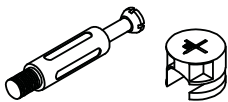
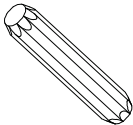
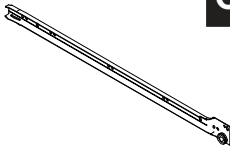
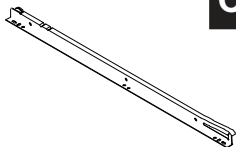
IT_Ruotare il bloccaggio a camma in senso orario per stringere.

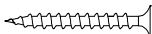
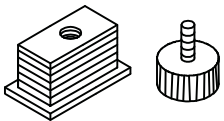

 <p>A x27 +1(spare)</p>	 <p>B x10 +1(spare)</p>	 <p>C1 x 2</p>
 <p>C2 x 2</p>	 <p>D x 2 M7*50</p>	 <p>E x 4 M6*30</p>
 <p>F x16 M3.5*14 +1(spare)</p>	 <p>G x 8 M3.5*35 +1(spare)</p>	 <p>H x 2</p>

A x 4

B x 2

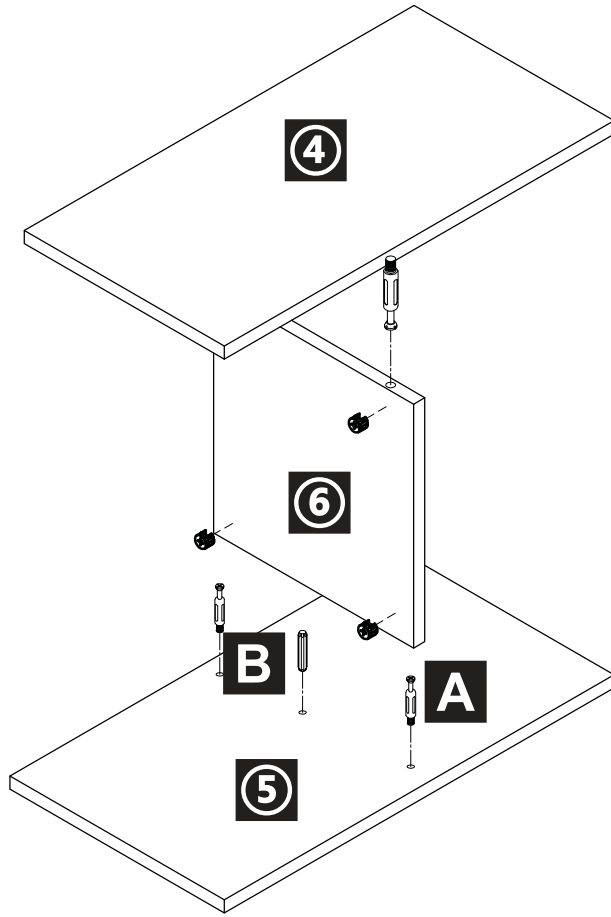

A x 8

B x 4

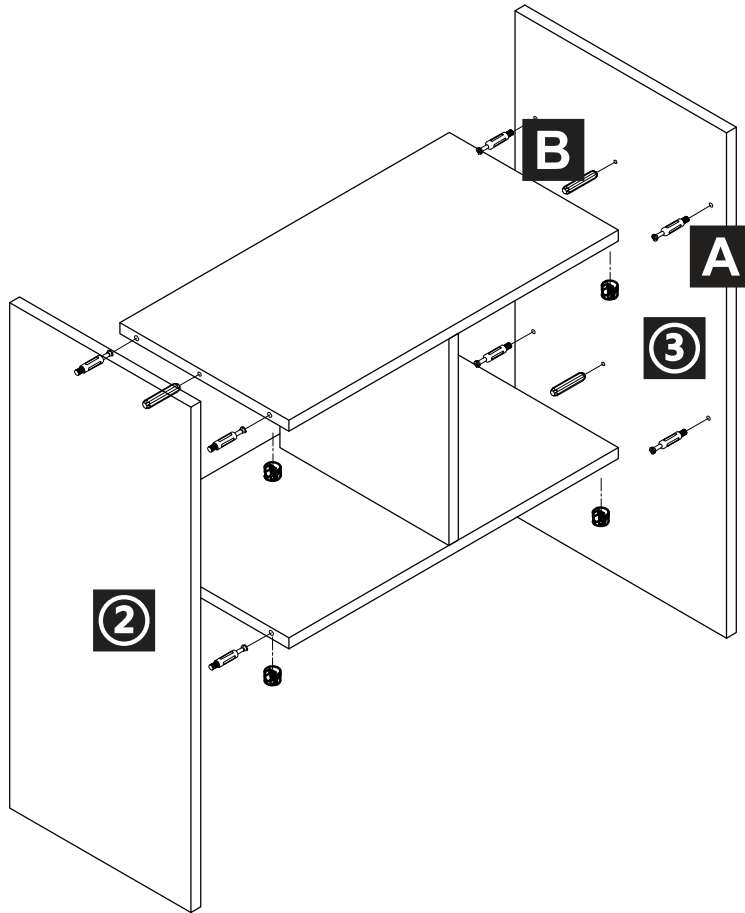

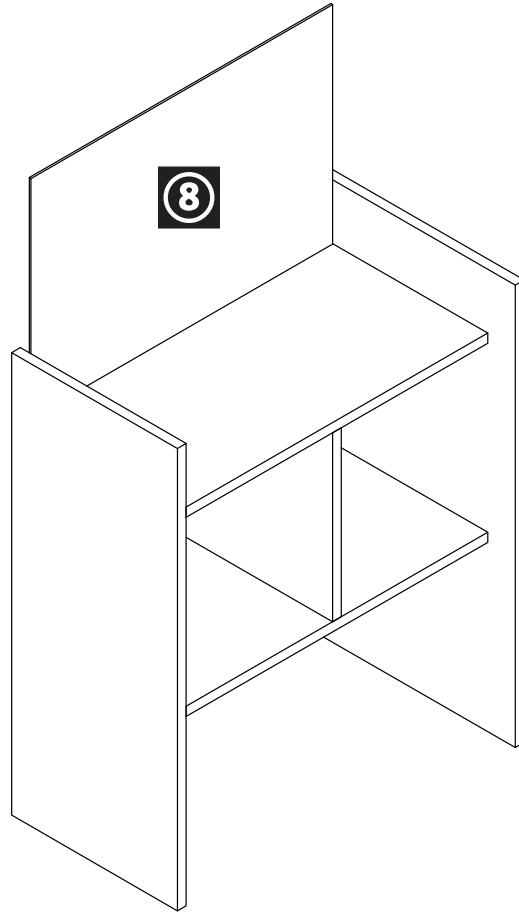

D x 2

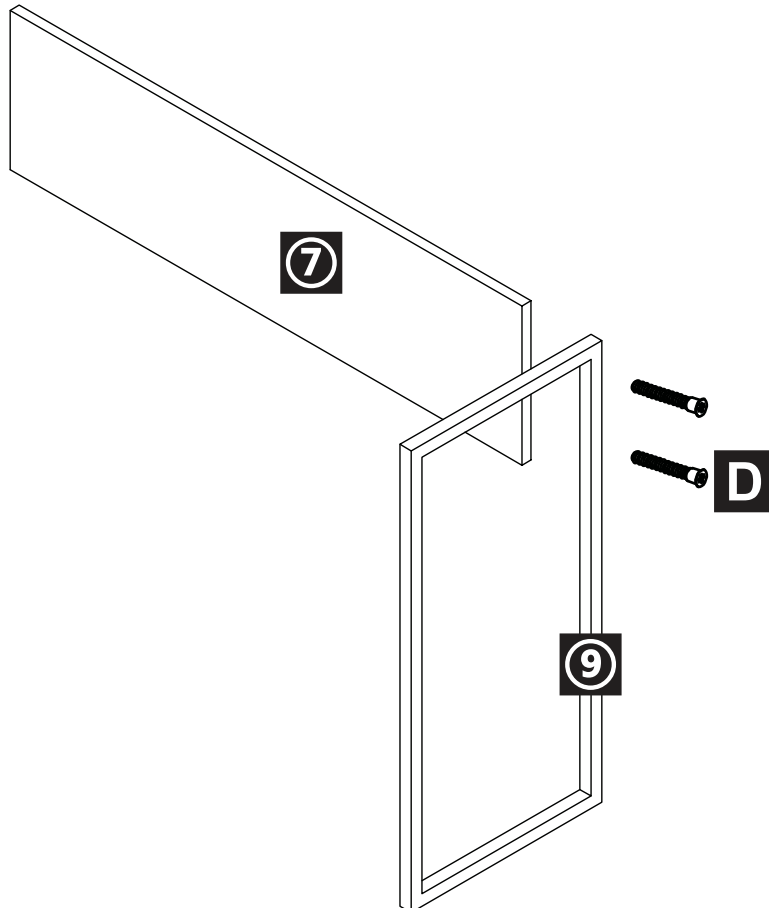

E x 2

H x 2

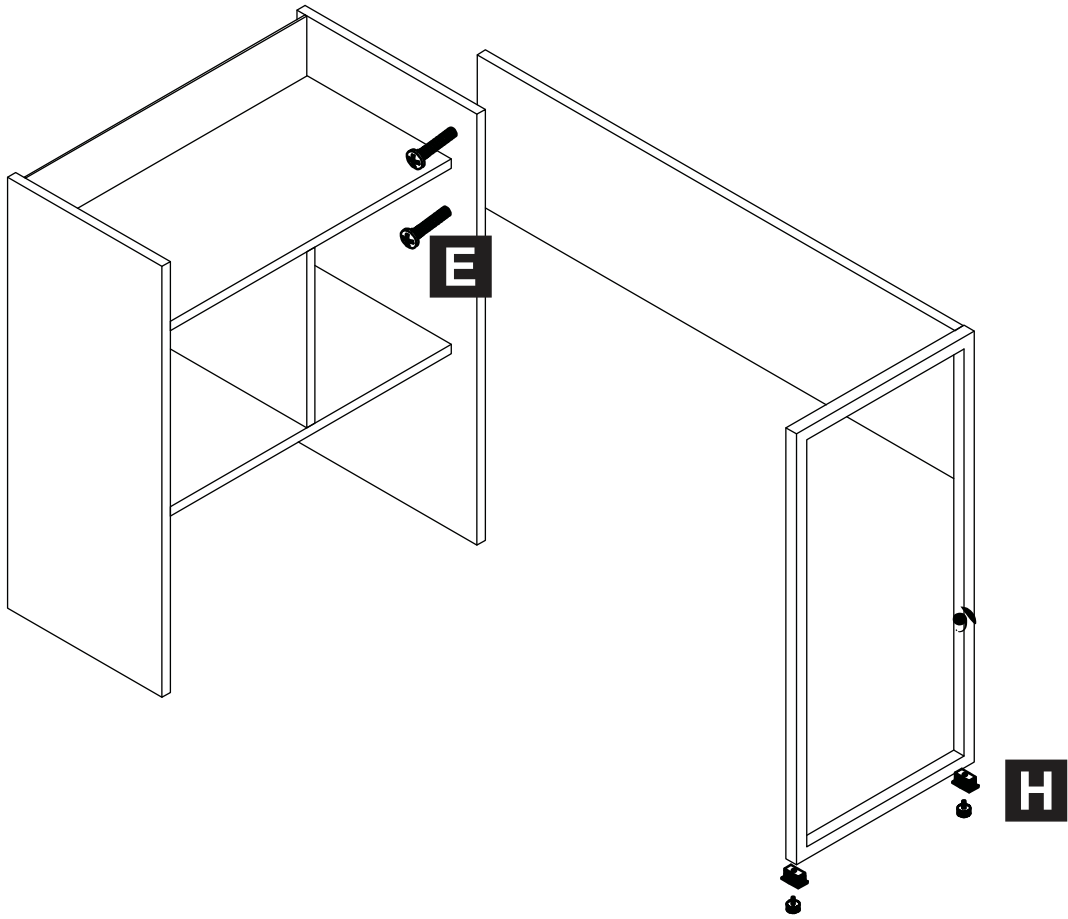

A x 7

B x 4

E x 2

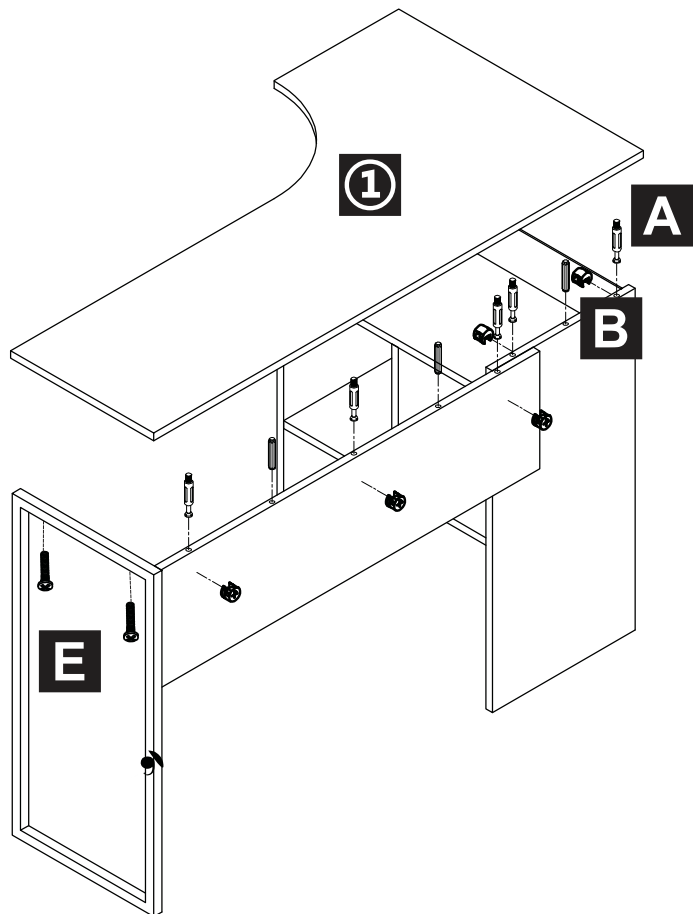

A x 8

C2 x 2

F x 8

G x 8

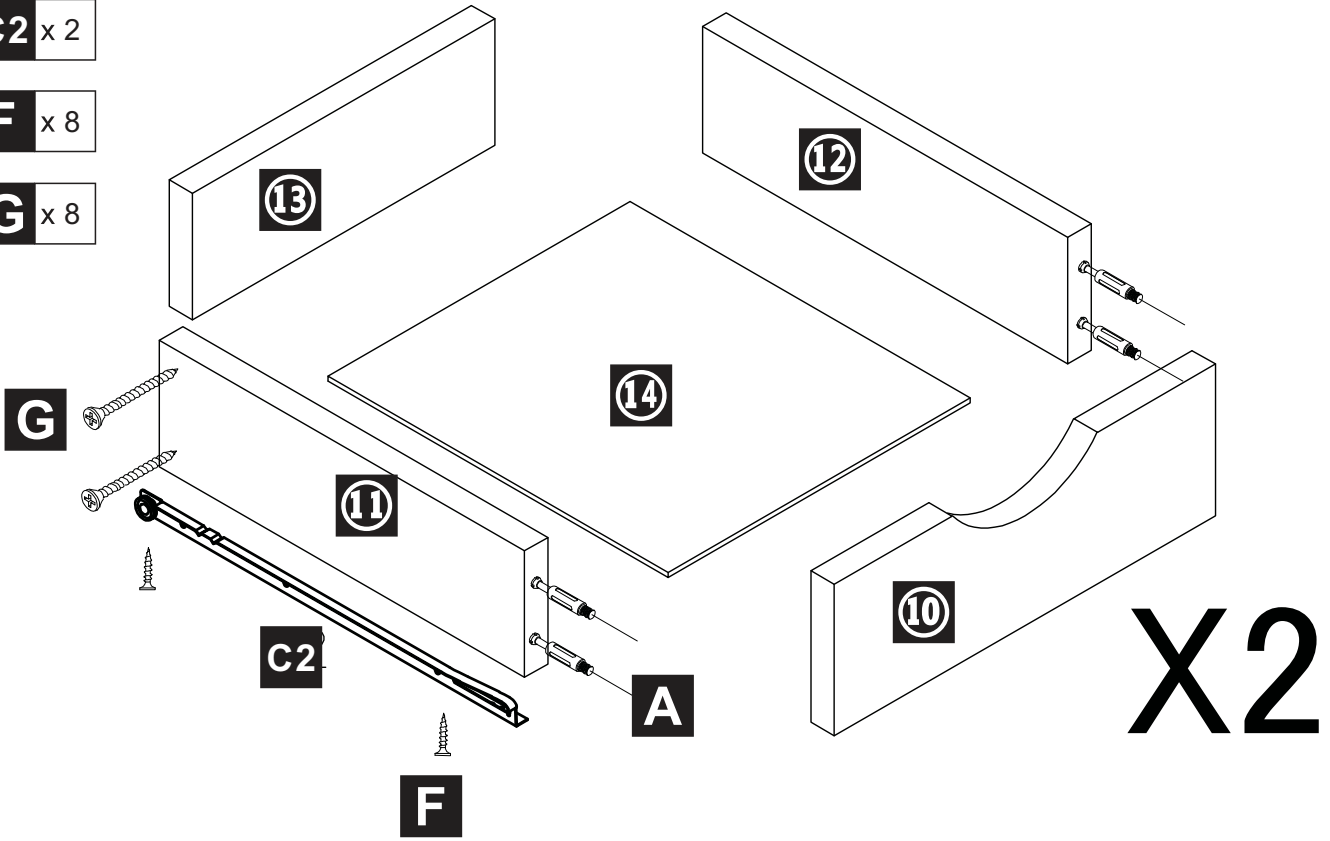

C1 x 2

F x 8

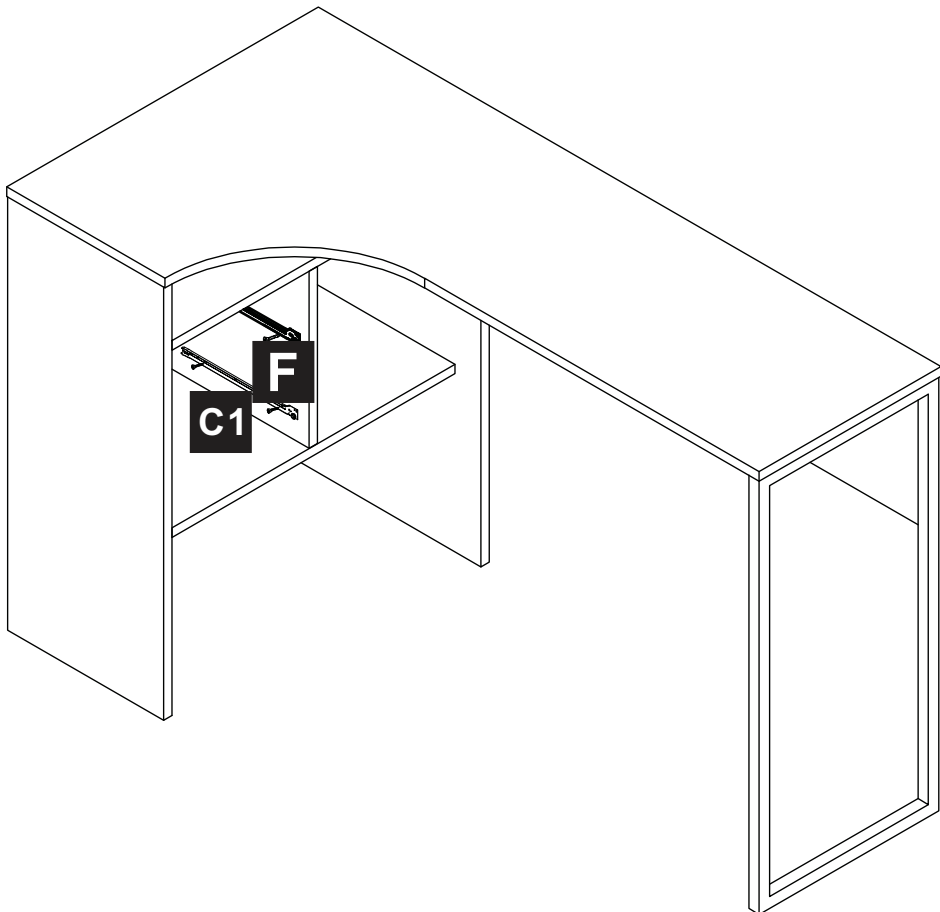

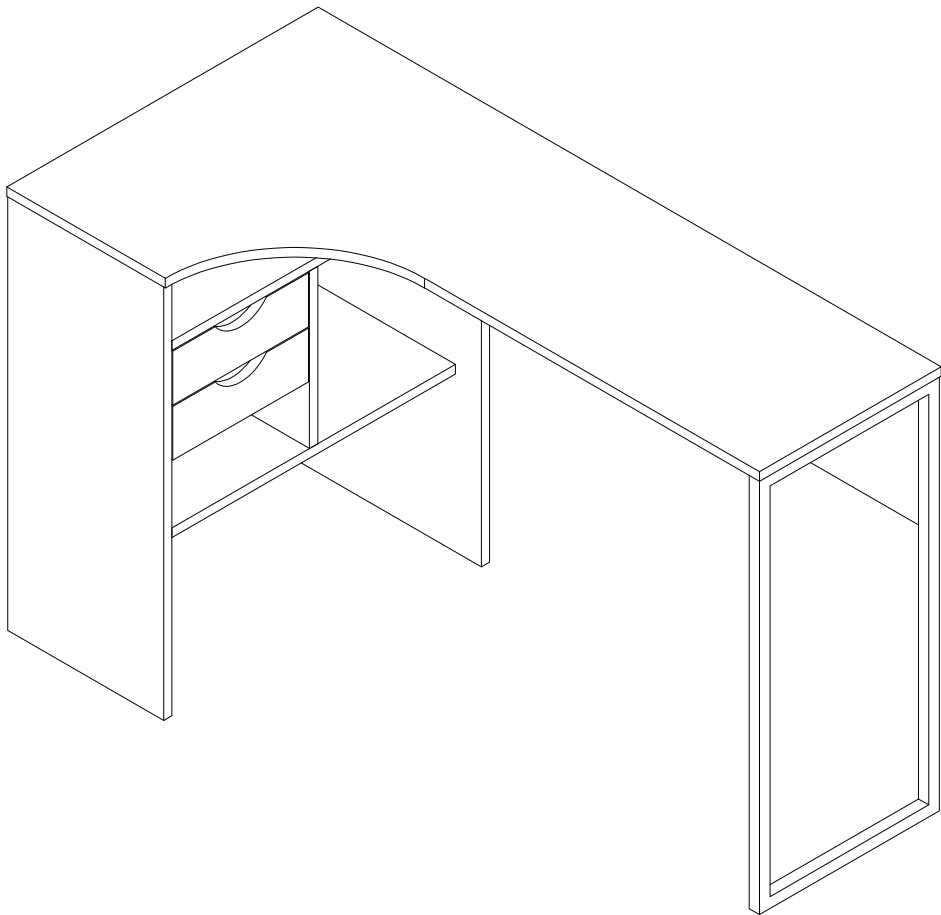
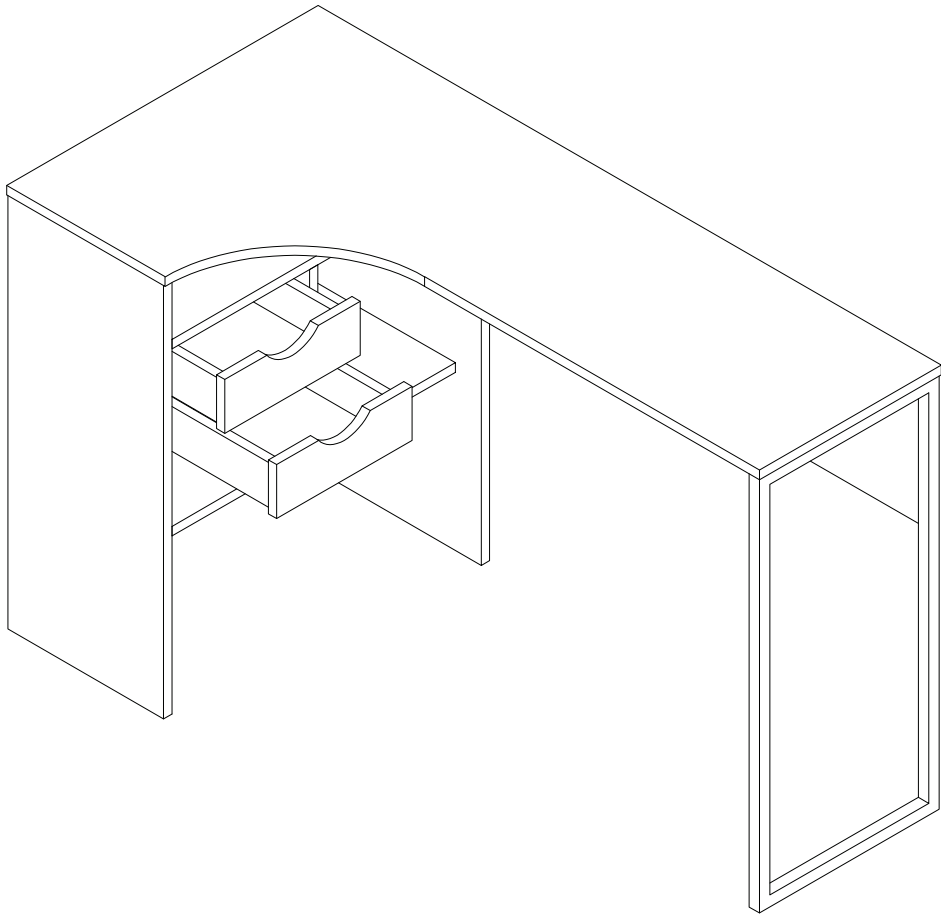

US



001-877-644-9366
customerservice@aosom.com

CA



001-855-537-6088
customerservice@aosom.ca

UK



0044-800-240-4004
enquiries@mhstar.co.uk

DE



0049-(0)40-88307530
service@aosom.de

FR



0033-1-84166106
contact@aosom.fr

ES



0034-931294512
atencioncliente@aosom.es

IT



0039-0249471447
clienti@aosom.it