

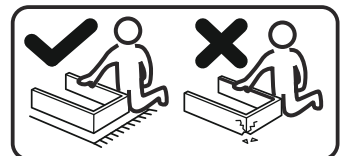

IN241000217V01\_GL

**831-642V00**

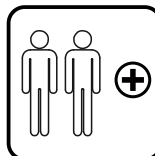
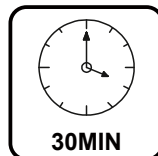
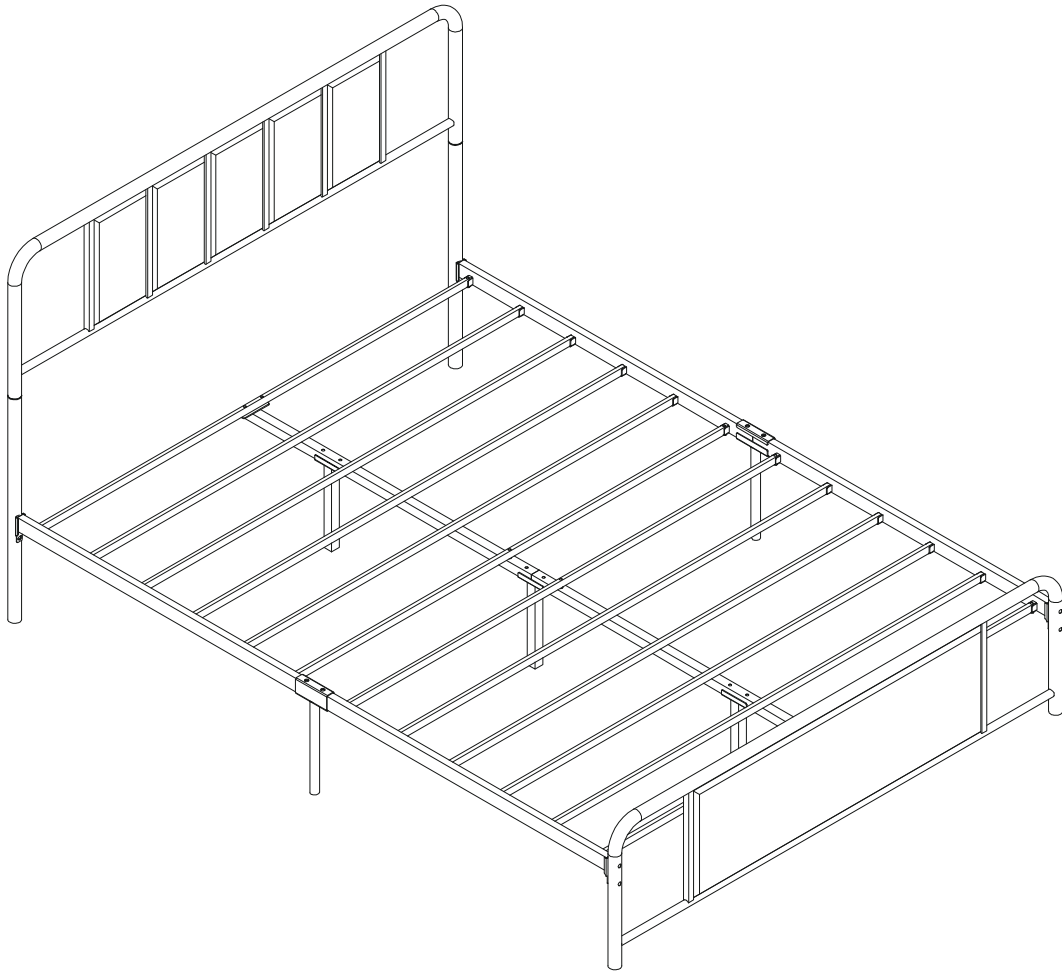

**EN\_IMPORTANT, RETAIN FOR FUTURE REFERENCE: READ CAREFULLY.**

**FR\_IMPORTANT: A LIRE ATTENTIVEMENT ET A CONSERVER POUR VOUS Y REFRERER ULTERIEUREMENT**

**ES\_IMPORTANTE, LEA DETENIDAMENTE Y GUARDE PARA FUTURAS REFERENCIAS.**

**PT\_IMPORTANTE, GARDE PARA FUTURA REFERÊNCIA, LEIA ATENTAMENTE.**

**DE\_WICHTIG! SORFGFÄLTIG LESEN UND FÜR SPÄTERES NACHSCHLAGEN AUFBEWAHREN.**

**IT\_IMPORTANTE, LEGGERE E CONSERVARE QUESTO MANUALE D'ISTRUZIONE PER UN USO FUTURO.**

## **EN Operation Instructions**

---

- Please confirm that all components are present before beginning assembly.
- For the protection of your furniture, place all parts on a clean and smooth surface to prevent any damage.
- Please assemble the furniture by 2 persons or more.
- Do not confuse similar screws.
- Do not tighten bolts fully until all parts are connected!
- Please periodically check all fitting and re-tighten as necessary.

## **FR Instructions pratiques**

---

- Avant de commencer l'assemblage, veuillez confirmer que tous les composants sont présents.
- Pour la protection de votre mobilier, placez toutes les pièces sur une surface propre et lisse de manière à éviter tout dommage.
- Veuillez procéder au montage de votre mobilier par 2 personnes ou plus.
- Ne pas confondre des vis similaires.
- Ne serrez pas les boulons à fond tant que toutes les pièces ne sont pas connectées!
- Veuillez vérifier périodiquement toutes les pièces de montage et les resserrer si nécessaire.

## **ES Instrucciones de operación**

---

- Por favor, confirme que todos los componentes están presentes antes de comenzar el ensamblaje.
- Para proteger sus muebles, coloque todas las piezas sobre una superficie limpia y lisa para evitar daños.
- El montaje debe ser realizado por 2 o más personas.
- No confunda tornillos similares.
- No apriete los tornillos completamente hasta que todas las partes están conectadas!
- Revise regularmente todos los accesorios y vuelva a apretarlos si es necesario.

## **PT Instruções de funcionamento**

---

- Por favor, confirme que todos os componentes estão presentes antes de começar a montagem.
- Para proteger o seu mobiliário, coloque todas as peças numa superfície limpa e lisa para evitar danos.
- A montagem deve ser realizada por 2 ou mais pessoas.
- Não confundir parafusos semelhantes.
- Não apertar completamente os parafusos até que todas as peças estejam encaixadas!
- Verifique regularmente todos os acessórios e aperte-os novamente, se necessário.

## **DE Betriebsanleitung**

---

- Bitte bestätigen Sie, dass alle Komponenten vor Beginn der Montage vorhanden sind.
- Legen Sie zum Schutz Ihres Möbels alle Teile auf eine saubere und glatte Unterlage, um Beschädigungen zu vermeiden.
- Bitte bauen Sie die Möbel mit mindestens 2 Personen zusammen.
- Verwechseln Sie ähnliche Schrauben nicht.
- Ziehen Sie die Schrauben erst fest an, wenn alle Teile verbunden sind!
- Überprüfen Sie bitte regelmäßig alle Befestigungen und ziehen Sie diese gegebenenfalls nach.

## **IT Istruzioni per l'uso**

---

- Prima di iniziare l'assemblaggio, confermare che tutti i componenti siano presenti.
- Per proteggere il tuo mobile, posiziona tutte le parti su una superficie pulita e liscia per evitare danni.
- Si prega di assemblare il mobile da 2 persone o più.
- Non confondere le viti simili.
- non serrare completamente i bulloni fino a tutte le parti non sono ancora collegate!
- Si prega di controllare periodicamente tutti i componenti di fissaggio e serrarli nuovamente se necessario.

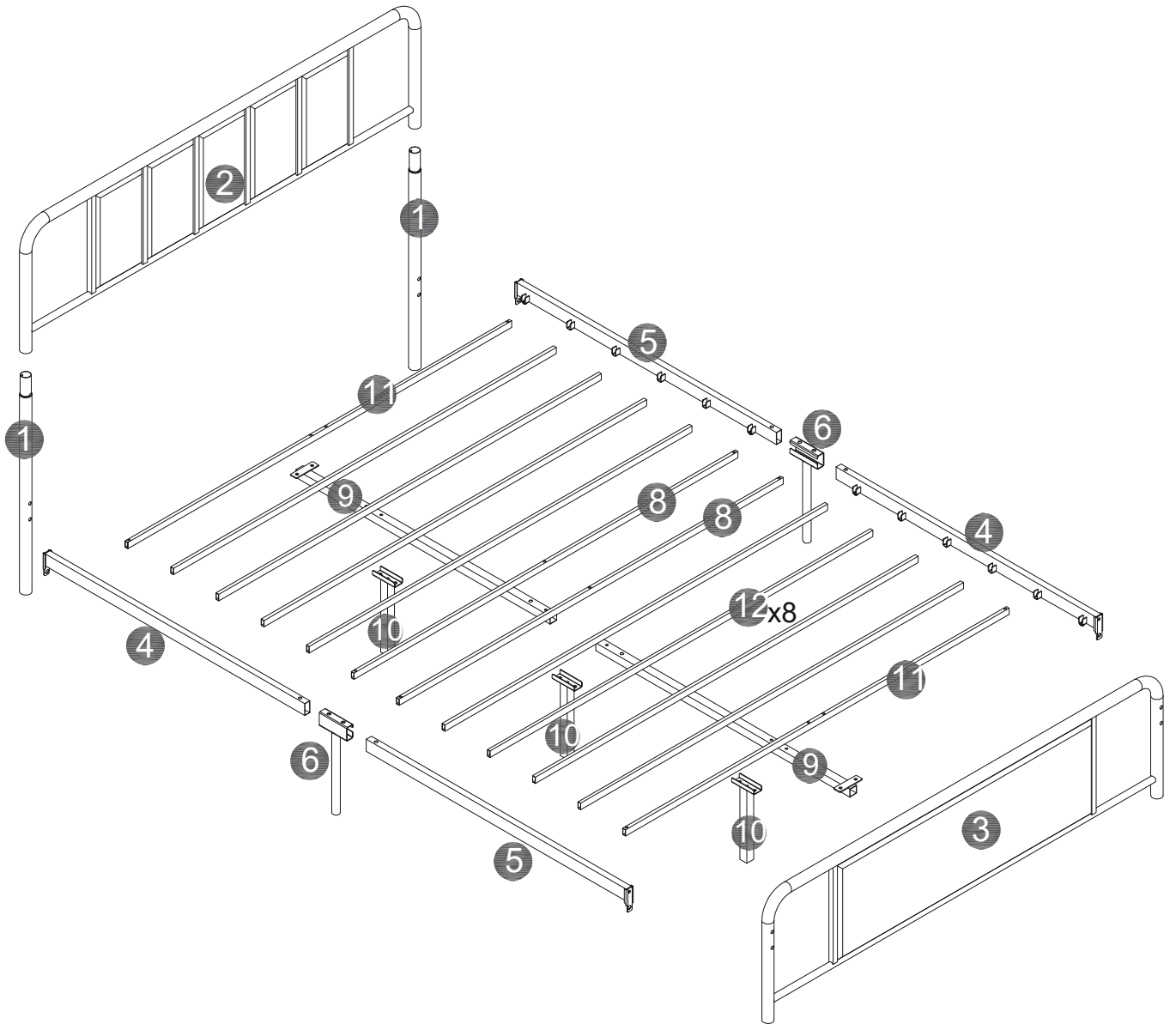



1  
x2

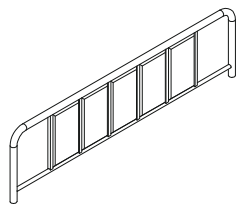

2  
x1

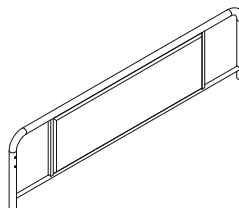

3  
x1

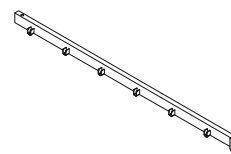

Right  
4  
x2

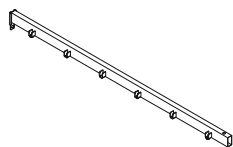

Left  
5  
x2



6  
x2

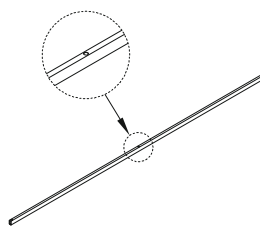

8  
x2

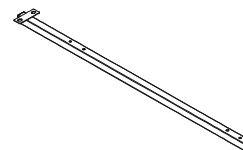

9  
x2

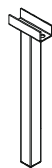

10  
x3

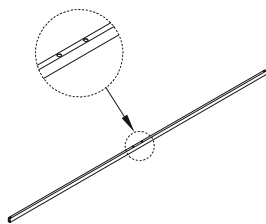

11  
x2

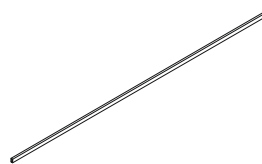

12  
x8



**A**  
M8\*50  
x8 +1(spare)



**B**  
M8  
x8 +1(spare)



**C**  
M6\*15  
x4PCS



**D**  
M8\*55  
x4



**E**  
M5\*25  
x8 +1(spare)

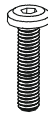

**F**  
M6\*35  
x12 +2(spare)



**G**  
Ø8  
x8 +1(spare)





**H**  
S4  
x1



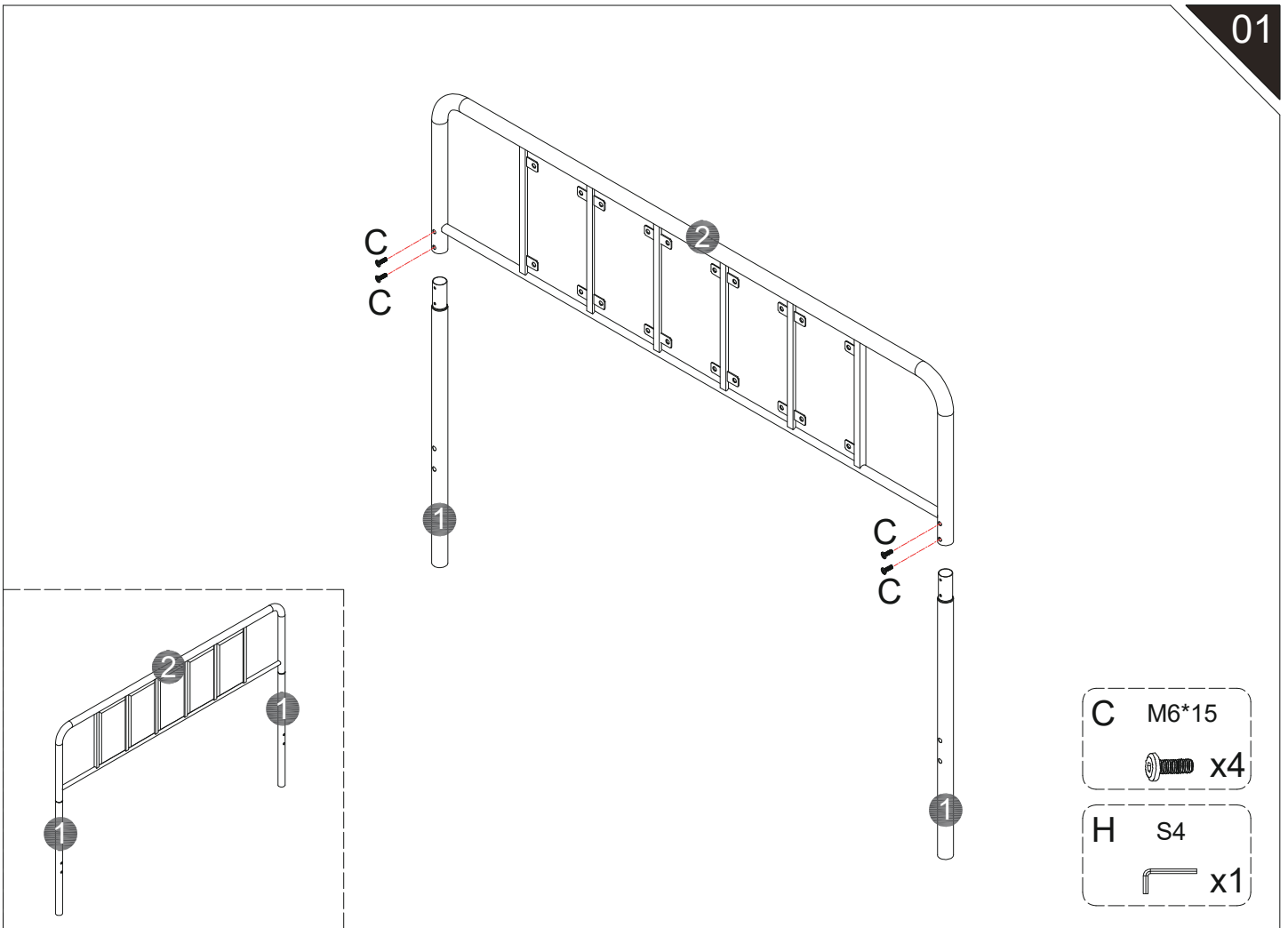



**I**  
S10,S13  
x1

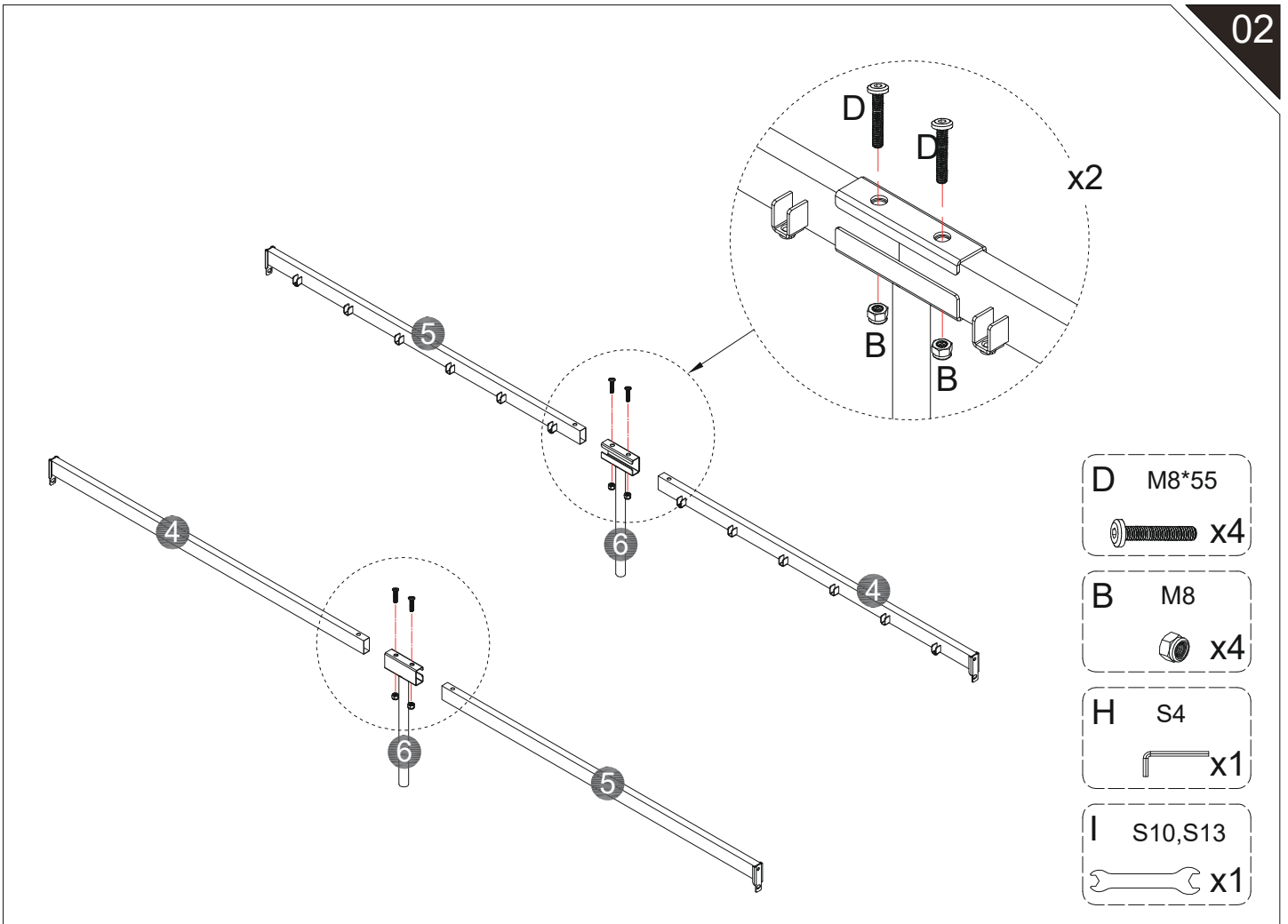



- C** M6\*15  
 x4
- H** S4  
 x1



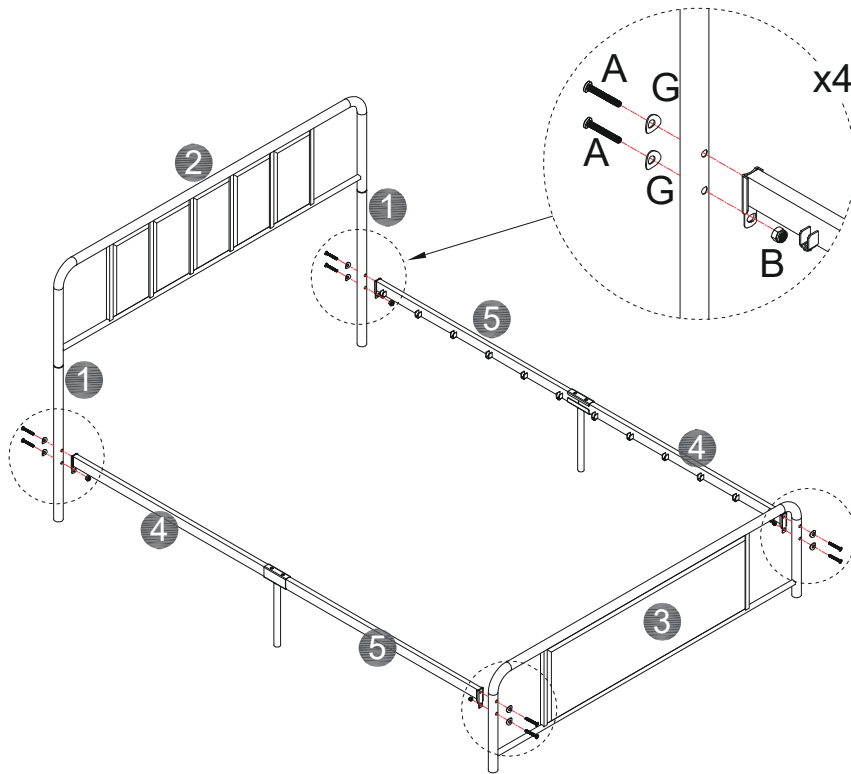

- D** M8\*55  
 x4
- B** M8  
 x4
- H** S4  
 x1
- I** S10,S13  
 x1



A M8\*50  
 x8

G Ø8  
 x8

B M8  
 x4

H S4  
 x1

I S10,S13  
 x1

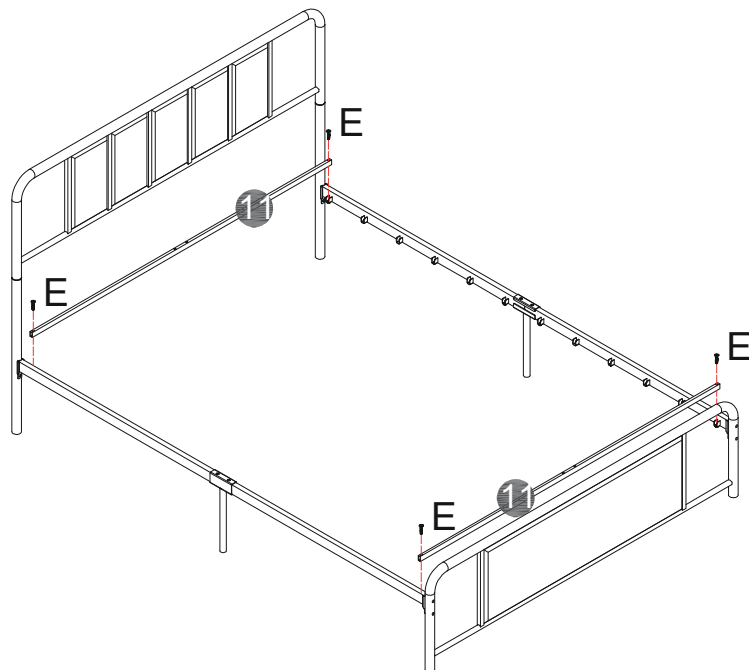

E M5\*25  
 x4

H S4  
 x1

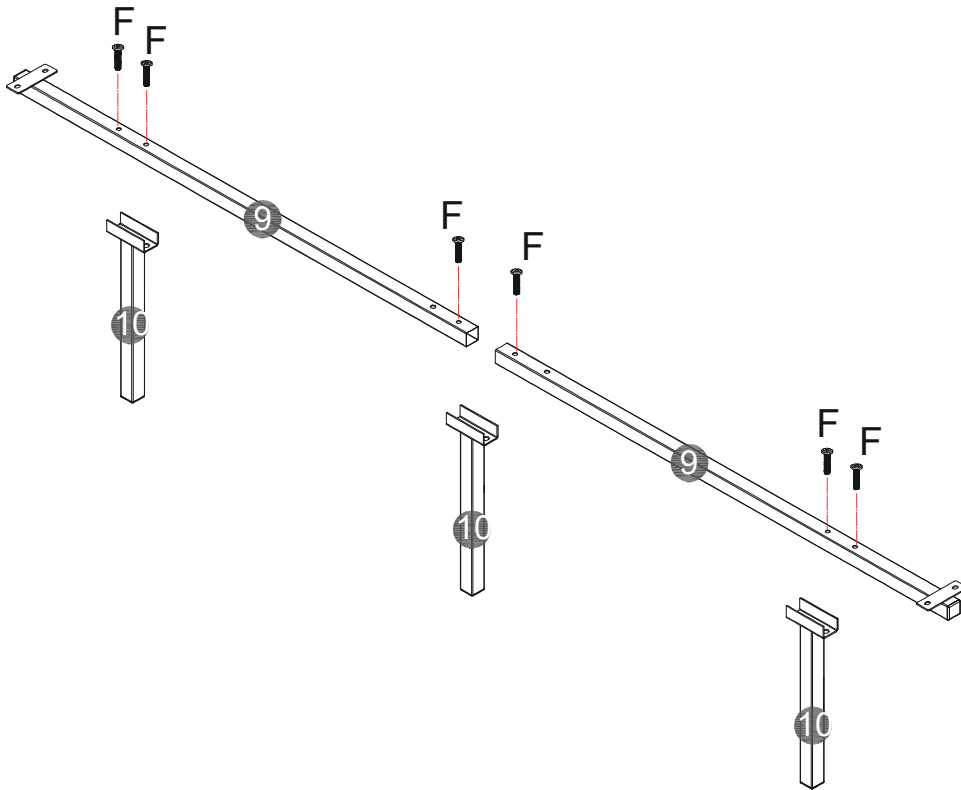

F M6\*35  
 x6

H S4  
 x1

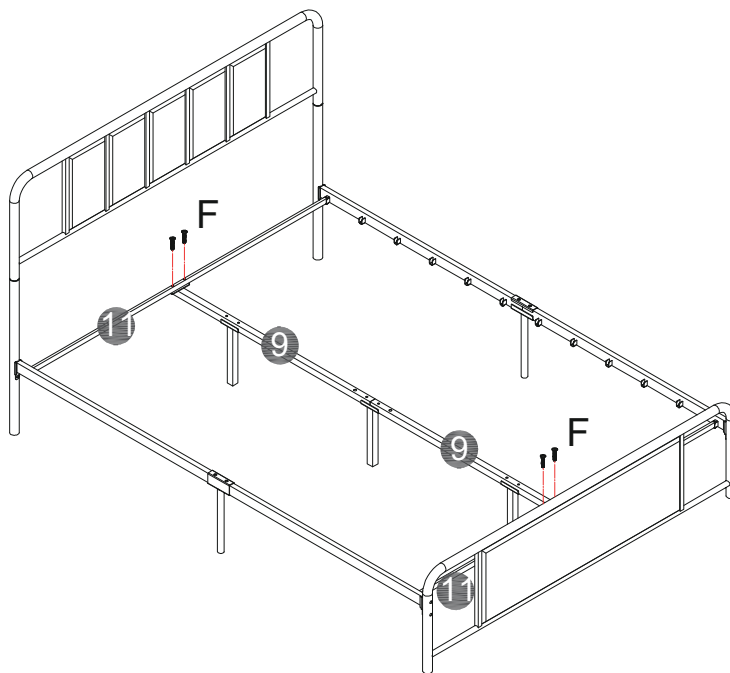

F M6\*35  
 x4

H S4  
 x1



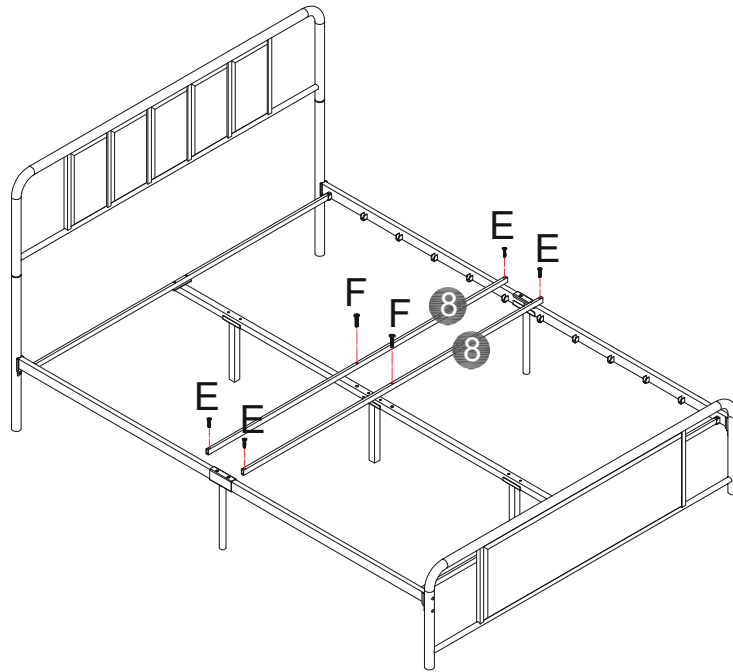

E M5\*25  
 x4

F M6\*35  
 x2

H S4  
 x1

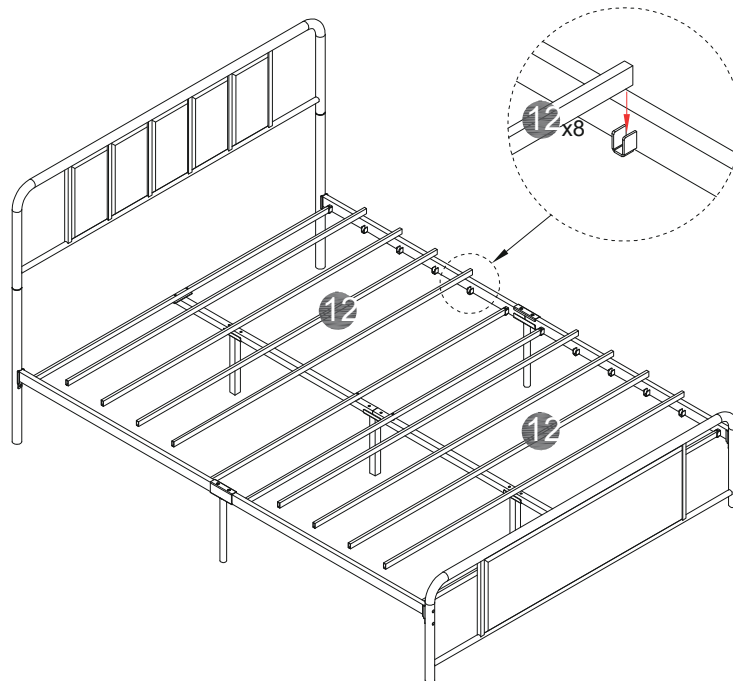

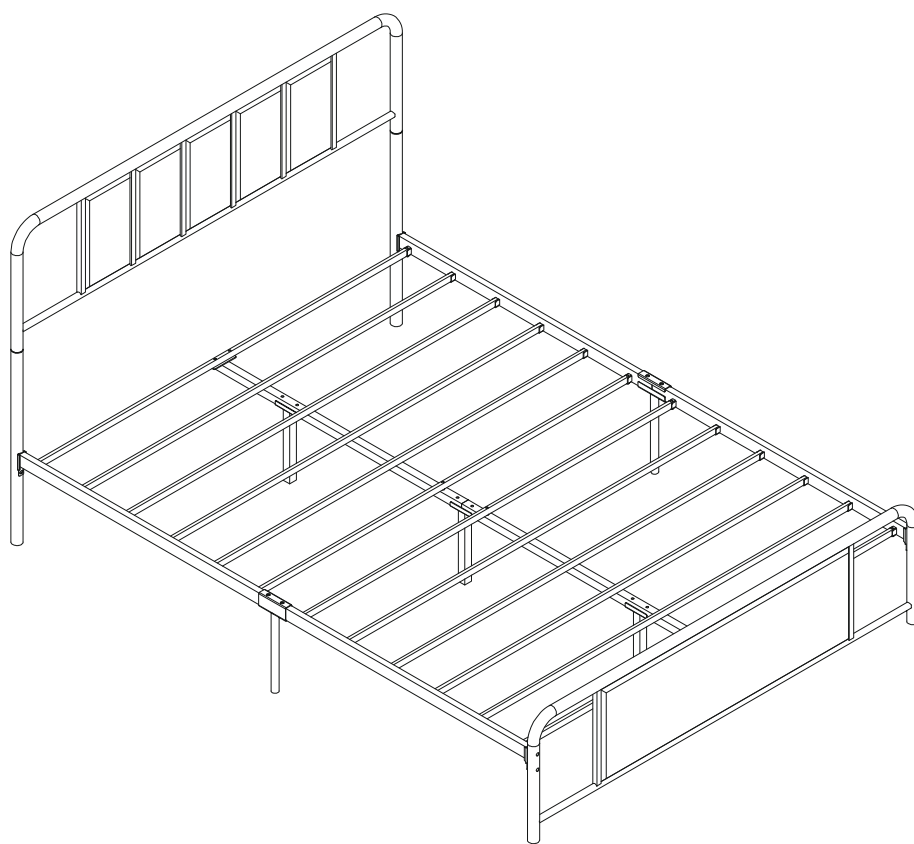

If you have any questions, please contact our customer care center, Our contact details are below:

**US**

 001-877-644-9366

 customerservice@aosom.com

Imported by Aosom LLC  
27150 SW Kinsman Rd Wilsonville, OR 97070 USA  
MADE IN CHINA

If you have any questions, please contact our customer care center, Our contact details are below:

**UK**

 0044-800-240-4004

 enquiries@mhstar.co.uk

IMPORTER ADDRESS:  
MH STAR UK LTD  
Unit 27, Perivale Park,  
Horsenden lane South  
Perivale, UB6 7RH  
MADE IN CHINA

If you have any questions, please contact our customer care center, Our contact details are below:

**CA**

Si vous avez la moindre question, veuillez contacter notre centre d'assistance à la clientèle, Nos coordonnées sont les suivantes:

 416-792-6088

 customerservice@aosom.ca

Imported by Aosom Canada Inc.  
7270 Woodbine Avenue, Unit 307, Markham,  
Ontario Canada L3R 4B9  
MADE IN CHINA

Importé par Aosom Canada Inc.  
7270 Woodbine Avenue, unité 307, Markham,  
Ontario Canada L3R 4B9  
FABRIQUÉ EN CHINE

Wenn Sie Fragen haben, wenden Sie sich bitte an unser Kundendienstzentrum, Unsere Kontaktdaten stehen unten:

**DE**

 0049-0(40)-88307530

 service@aosom.de

ADRESSE DES IMPORTEUR/Hersteller/REP:  
MH Handel GmbH Wendenstraße 309 D-20537  
Hamburg  
Germany  
IN CHINA HERGESTELLT

In caso di dubbio, si prega di contattare il nostro centro assistenza clienti, I nostri dettagli di contatto sono di seguito:

**IT**

 0039-0249471447

 clienti@aosom.it

IMPORTATO DA/Produttore/REP: AOSOM Italy srl  
Centro Direzionale Milanofiori Strada 1 Palazzo F1  
20057 Assago (MI)  
P.I.: 08567220960  
FATTO IN CINA

Si tiene alguna pregunta, comuníquese con nuestro Centro de Atención al Cliente, Nuestros datos de contacto son los siguientes:

**ES**

 0034-931294512

 atencioncliente@aosom.es

IMPORTADOR/Fabricante/REP:  
SPANISH AOSOM, S.L.  
C/ROC GROS, Nº15.08550, ELS HOSTALET DE  
BALENYÀ, SPAIN.  
B66295775  
HECHO EN CHINA

Se tiver alguma dúvida, por favor contacte o nosso Centro de Atendimento ao Cliente, Os nossos dados de contacto são os seguintes:

**PT**

 0034-931294512

 info@aosom.pt.

IMPORTADOR/Fabricante/REP: SPANISH  
AOSOM, S.L C.ROC GROS N.15, 08550. ELS  
HOSTALET DE BALENYÀ  
FEITO NA CHINA

Si vous avez la moindre question, veuillez contacter notre centre d'assistance à la clientèle, Nos coordonnées sont les suivantes:

**FR**

 0033-1-84166106  aosom@mhfrance.fr

Importé par/Fabricant/REP: MH FRANCE 2 Rue Maurice Hartmann 92130 Issy Les Moulinaux  
France  
FABRIQUÉ EN CHINE



**FR**

**DONNEZ  
OU  
RECYCLEZ**



OU



OU



ASSOCIATION LIVRAISON DÉCHÈTERIE

Adresses sur [quefairedemesdechets.fr](http://quefairedemesdechets.fr)