

## PULL-UP FITNESS EQUIPMENT

Warm remind:







**Open the package to confirm components**

IMPORTANT, RETAIN FOR FUTURE REFERENCE: READ CAREFULLY

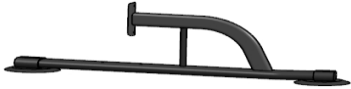
# ASSEMBLY INSTRUCTION

## ASSEMBLY INSTRUCTION

---

Base		2
Main Frame		2
Upper arm		2
Supervisor connection		1
Reinforced tube		2
Backrest bar		1
horizontal bar		1

## ASSEMBLY INSTRUCTION

### Toolkit accessories

(1) Half round square neck screw M8*40 (4 pieces)	(2) Hexagon screw M8*80 (2 pieces)	(3) Hexagon screw M8*70 (4 pieces)
		
(4) Hexagon screw M8*40 (4 pieces)	(5) Hexagon screw M8*15 (6 pieces)	(6) Plastic handle screw M8*45 (4 pieces)
		
(7) Plastic handle nut M8 (4 pieces)	(8) Nut M8 (14 pieces)	(9) Curved gasket (2 pieces)
		
(10) Strengthen gasket (2 pieces)	(11) Round gasket (4 pieces)	(12) Curved gasket (14 pieces)
		
(13) Hexagon socket stud M6*20 (6 pcs)	(14) Outer hex wrench (1 piece) (15) Inner hex wrench (2 pieces)	
		

### Step 1: Install four-foot covers

Take out the left and right leg tubes (note that the bottom leg covers are parallel to the ground).

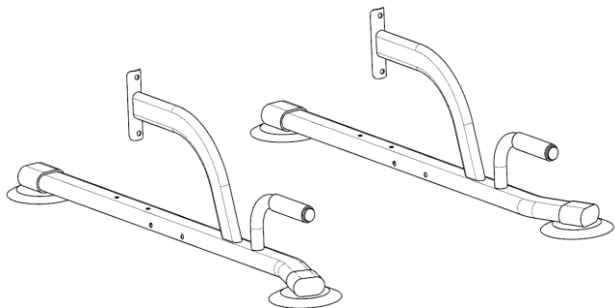

### Step 2: Install the main frame

- ① To install the main pipe and the leg pipe, use 4 M8\*40 round head square neck screws to pass through the leg pipe from the bottom, put on the round backing plate, and fasten with M8 nuts. The reinforced pipe and the main pipe are installed by using 4 M8\*70 inner hexagonal screws to pass through the inner main pipe, put on the curved backing

plate, and fasten with M8 nuts.

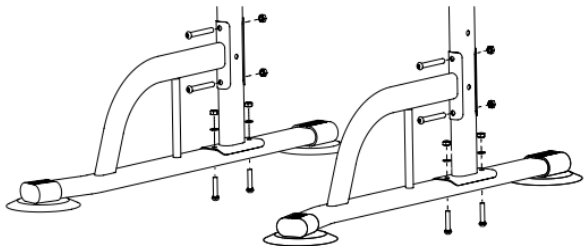

**Step 3: Install the main frame connecting pipe**

Use four external hexagonal M8\*40 screws to pass through the main pipe from the inside, put on the reinforced backing plate, and fasten with M8 nuts.

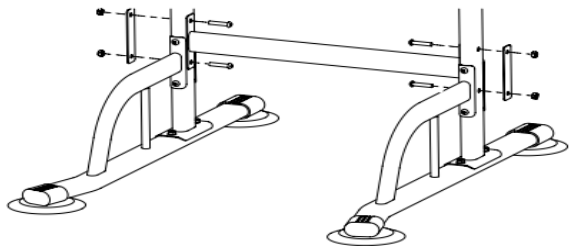

#### Step 4: Install parallel bars

Align the holes at the upper and lower ends, use four M6\*20 studs with arc-shaped washers, pass through the parallel bar frame, and tighten with two M6\*15 screws plus arc-shaped washers and studs.

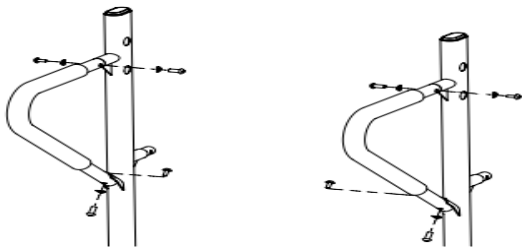

#### Step 5: Install the backrest bar

Align the holes, use four M6\*20 studs to pass through the arc-shaped washer, and use four M6\*15 screws plus the arc-shaped washer to fasten.

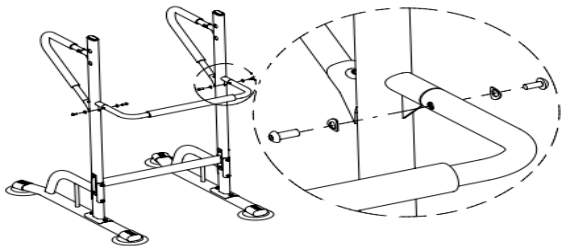

### **Step 6: Install the horizontal bar**

Place the horizontal bar on the upper arm, align the holes with M8\*80 hexagon socket screws, put on the arc-shaped washer, pass through the bottom, add the arc-shaped washer, and fasten with m8 nuts.

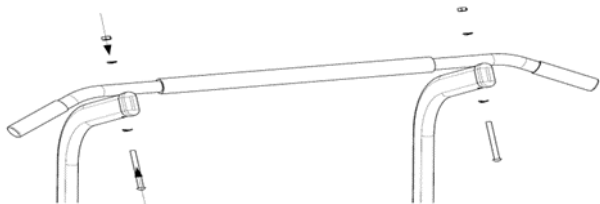

**Step 7: Install the auxiliary pipe and adjust the height to suit you**

Directly insert the auxiliary pipe from the top of the main frame. When the height is adjusted to the appropriate height, align the holes and use M8\*45 plastic handle screws to pass through the main frame and the auxiliary pipe to fasten with M8 plastic handle nuts.

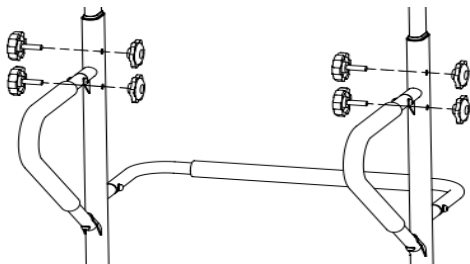



Installation is complete: as shown

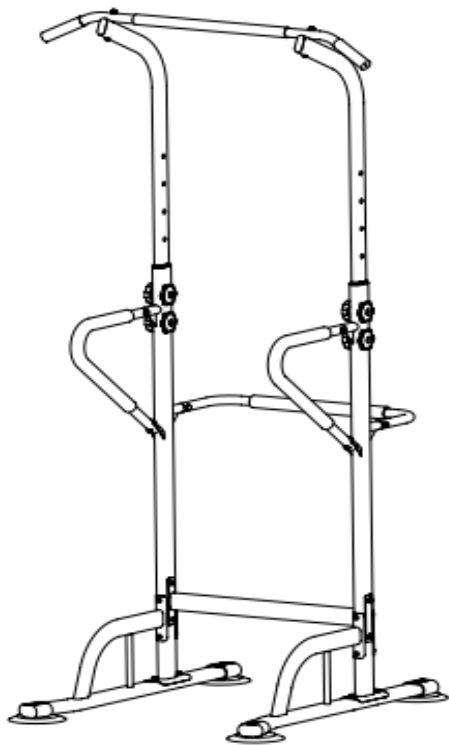

## INSTRUCCIONES DE MONTAJE

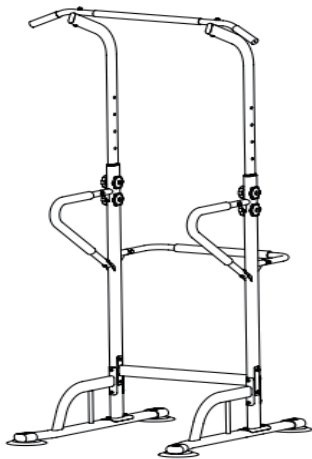







### EQUIPO DE PULL-UP

Consejos amistosos:

**Abra el paquete para confirmar e identificar los componentes**

LEA Y GUARDE TODO EL MANUAL PARA LAS REFERENCIAS FUTURAS.

## INSTRUCCIONES DE MONTAJE

Base		2
marco principal		2
Tubo auxiliar		2
Tubo de conexión		1
Tubo de refuerzo		2
Barra de respaldo		1
Barra horizontal		1

## INSTRUCCIONES DE MONTAJE

### Accesorios del kit de herramientas

(1) Tornillo de cuello cuadrado y cabeza redonda M8 * 40 (4 piezas)	(2) Tornillo hexagonal M8 * 80 (2 piezas)	(3) Tornillo hexagonal M8 * 70 (4 piezas)
		
(4) Tornillo hexagonal M8 * 40 (4 piezas)	(5) Tornillo hexagonal M8 * 15 (6 piezas)	(6) Tornillo de manija de plástico M8 * 45 (4 piezas)
		
(7) Tuerca de manija de plástico M8 (4 piezas)	(8) Tuerca M8 (14 piezas)	(9) Junta curva (2 piezas)
		
(10) Junta de refuerzo (2 piezas)	(11) Junta redonda (4 piezas)	(12) Junta curva (14 piezas)
		
(13) Clavo hexagonal M6 * 20 (6 piezas)	(14) Llave hexagonal exterior (1 pieza)	(15) Llave hexagonal interior (2 piezas)
		

### Paso 1: Montar las cubiertas de cuatro patas

Saque los tubos de las patas izquierda y derecha (Tenga en cuenta que las cubiertas de patas inferiores deben estar paralelas al piso).

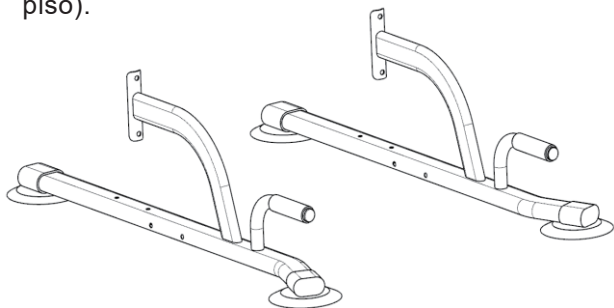

### Paso 2: Montar el marco principal

Para montar el tubo principal y el tubo de pata, pase los 4 tornillos de cuello cuadrado y cabeza redonda M8 \* 40 a través del tubo de pata desde la parte inferior, coloque la placa de la parte trasera redonda y fíjela con las tuercas M8. Para instalar el tubo de refuerzo y el tubo principal, pase los 4 tornillos hexagonales interiores M8 \* 70 a través del tubo principal interior, coloque la placa de la parte trasera curvada y sujételos con las tuercas M8.

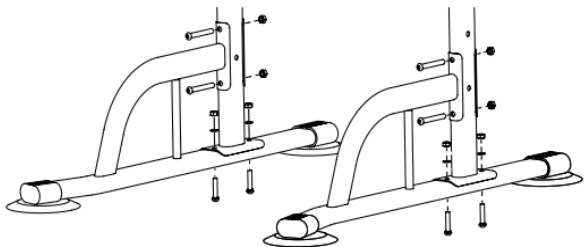

### Paso 3: Para instalar el tubo de conexión del marco principal

Pase los 4 tornillos hexagonales exteriores M8 \* 40 a través del tubo principal desde el interior, coloque la placa de refuerzo de la parte trasera y fíjela con las tuercas M8.

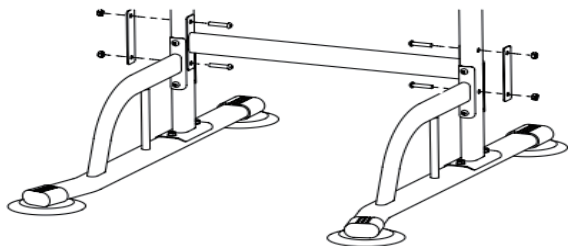

### Paso 4: Montar las barras paralelas

Alinee los orificios ubicados en los extremos superior e inferior, pase los 4 clavos M6 \* 20 con arandelas de arco a través del marco de barras paralelas, luego apriete los 2 tornillos M6 \* 15 con arandelas de arco y los clavos.

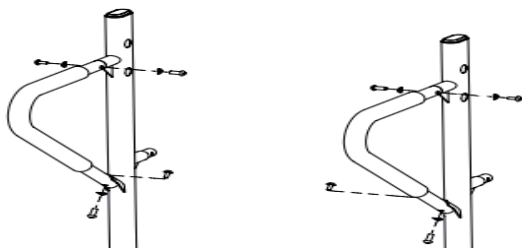

### Paso 5: Montar la barra del respaldo

Alinee los orificios, pase los 4 clavos M6 \* 20 a través de la arandela de arco, y sujételos con los 4 tornillos M6 \* 15 con arandelas de arco.

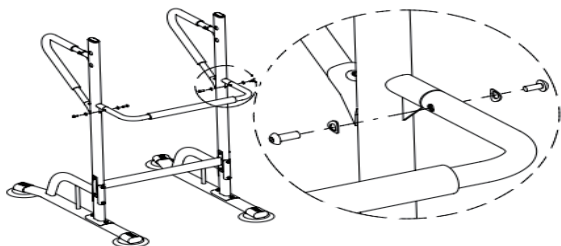

### Paso 6: Montar la barra horizontal

Coloque la barra horizontal en el brazo superior, alinee los orificios con los tornillos hexagonales M8 \* 80, coloque la arandela de arco. Pase los tornillos por la parte inferior, agregue la arandela de arco, luego apriételes con las tuercas M8.





### Paso 7: Montar el tubo auxiliar y ajustar la altura a la adecuada para usted

Inserte directamente el tubo auxiliar desde la parte superior del marco principal. Cuando la altura esté ajustada a la altura adecuada, alinee los orificios y pase los tornillos de manija de plástico M8 \* 45 a través del marco principal y el tubo auxiliar, sujételos con las tuercas de manija de plástico M8.

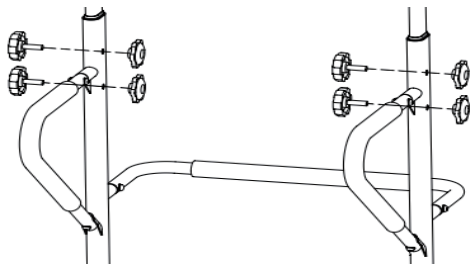

El montaje está listo: Como lo que se muestra en la imagen.

