

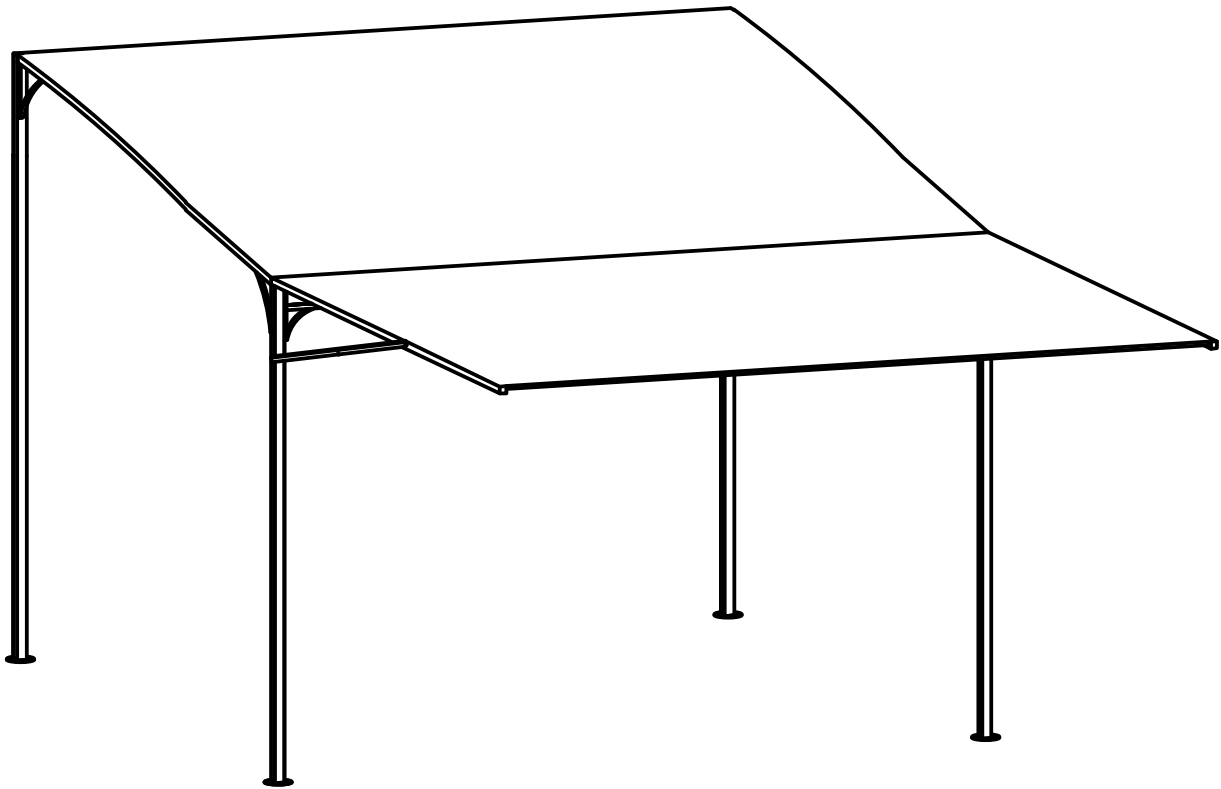

INbec048V03_GL

84C-135



Assembly video please scan the QR code .

IMPORTANT, RETAIN FOR FUTURE REFERENCE: READ CAREFULLY

ASSEMBLY & INSTRUCTION MANUAL

IMPORTANT SAFETY NOTICE

EN

Product is NOT INTENDED for the following:

- A safety barrier to prevent unsupervised access to pools, hot tubs, spas or ponds.
- As load bearing support for a building, structure, heavy objects or swings.
- Used in structures that trap wind, rain or snow that would create extra load on the product.

Accumulated snow must be removed from roof.

DO NOT climb or walk on roof for any reason.

Wear gloves to avoid injury from possible sharp edges of individual elements before assembly.

During installation, follow all safety warnings provided with your tools.

Some structures may require two or more people to install safely.

Check for underground utilities before digging or driving stakes into the ground!

It is important during assembly to closely follow the instructions, complete the assembly on a solid level surface and that you follow the instruction to square up, level and anchor the structure, this will reduce the gap at connections during assembly.

AVIS IMPORTANT DE SÉCURITÉ

FR

Le produit n'est PAS DESTINÉ à ce qui suit :

- Une barrière de sécurité pour empêcher l'accès non surveillé aux piscines, aux spas, aux cuves thermales ou aux étangs.
- Comme support de charge pour un bâtiment, une structure, des objets lourds ou des balançoires.
- Utilisé dans des structures qui retiennent le vent, la pluie ou la neige qui créeraient une charge supplémentaire sur le produit.

La neige accumulée doit être enlevée du toit.

NE PAS grimper ou marcher sur le toit pour quelque raison que ce soit.

Portez des gants pour éviter les blessures causées par d'éventuels bords tranchants des composants avant de procéder à l'assemblage.

Lors de l'installation, respectez tous les avertissements de sécurité fournis avec vos outils.

Certaines structures peuvent nécessiter l'intervention de deux personnes ou plus pour les installer en toute sécurité.

Vérifiez la présence de services publics souterrains avant de creuser ou de planter des piquets dans le sol !

Il est important, pendant tout le processus de montage, de suivre attentivement les instructions, de terminer l'assemblage sur une surface solide et plane et de suivre les instructions d'équerrage, de mise à niveau et d'ancrage de la structure, ce qui permettra de réduire les écarts au niveau des liaisons pendant le montage.

AVISO IMPORTANTE DE SEGURIDAD

ES

El producto NO ESTÁ DESTINADO para las condiciones siguientes:

- Como una barrera de seguridad para evitar el acceso a piscinas, jacuzzis, spas o estanques sin supervisión.
- Como un soporte de carga para un edificio, estructura, objetos pesados o columpios.
- Se utiliza en las estructuras que atrapan el viento, o acumulan la lluvia o la nieve, porque estos crearían una carga adicional para el producto.

La nieve acumulada debe ser retirada del techo.

NO suba ni camine sobre el techo por ningún motivo.

Use guantes para evitar lesiones por posibles bordes afilados antes de realizar el montaje.

Cuando realice el montaje, siga todas las advertencias de seguridad proporcionadas sobre sus herramientas.

Algunas estructuras pueden requerir que dos o más personas las instalen juntas para proteger seguridad de todas las partes.

¡Compruebe si hay servicios públicos subterráneos antes de excavar o clavar estacas en el suelo!

Durante el montaje, es muy importante seguir las instrucciones rígidamente y realizar el montaje sobre una superficie sólida y nivelada. Siempre siga las instrucciones para cuadrar, nivelar y anclar la estructura, así se reducirá el espacio entre las conexiones.

Das Produkt ist NICHT für einen der folgenden Anwendungen bestimmt:

- Als Sicherheitsbarriere, die den unbeaufsichtigten Zugang zu Pools, Whirlpools, Spas oder Teichen verhindert.
- Als tragende Stütze für ein Gebäude, eine Struktur, schwere Gegenstände oder Schaukeln.
- Als Bestandteil einer Struktur verwendet werden, welche Wind, Regen oder Schnee abfangen, die eine zusätzliche Belastung für das Produkt darstellen würden.

Angesammelter Schnee muss vom Dach entfernt werden.

Aus keinem Grund darf das Dach bestiegen oder betreten werden.

Bitte tragen Sie stets geeignete Arbeitshandschuhe, um Verletzungen durch mögliche scharfe Kanten einzelner Elemente während der Montage zu vermeiden.

Befolgen Sie während des Installationsprozesses bitte sorgfältig alle Sicherheitswarnungen, die mit Ihren Werkzeugen geliefert werden.

Einige Strukturen können zwei oder mehr Personen erfordern, um sicher installiert zu werden.

Prüfen Sie vor dem Graben oder Eintreiben von Pfählen in den Boden, ob Erdkabel vorhanden sind!

Es ist wichtig, während der Montage die Anweisungen genau zu befolgen, Ihr Produkt auf einem festen und ebenen Untergrund aufzustellen und die Anweisung zum Aufrichten, Nivellieren und Verankern der Struktur zu befolgen, da dadurch der Spalt an den Verbindungen während der Montage verringert wird.

Il prodotto NON è PROGETTATO per quanto segue:

- Una barriera di sicurezza per impedire l'accesso senza supervisione a piscine, vasche idromassaggio, spa o stagni.
- Supporto portante di edifici, strutture, oggetti pesanti o altalene.
- Parte di strutture che accumulano vento, pioggia o neve, in quanto creerebbero un carico extra sul prodotto.

La neve accumulata deve essere rimossa dal tetto.

NON salire o camminare sul tetto per nessun motivo.

Indossare guanti per evitare lesioni derivanti da spigoli vivi dei singoli componenti prima del montaggio.

Durante l'installazione, seguire tutte le precauzioni di sicurezza fornite con gli strumenti.

Alcune strutture possono richiedere due o più persone per essere installate in sicurezza.

Controlla le utenze sotterranee prima di scavare o piantare pali nel terreno!

È importante che durante il montaggio vengano seguite attentamente le istruzioni, inoltre completare il montaggio su una superficie piana e solida e seguire le istruzioni per allineare, livellare e ancorare la struttura, in quanto questo ridurrà lo spazio necessario durante il montaggio.

A x 2

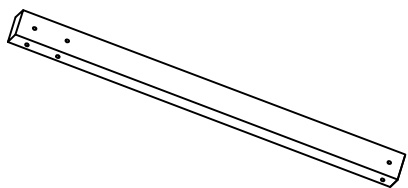

A1 x 4

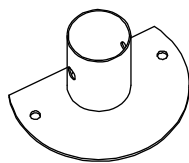

B x 1

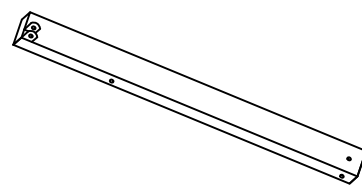

B1 x 1

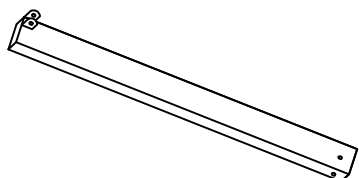

C x 2

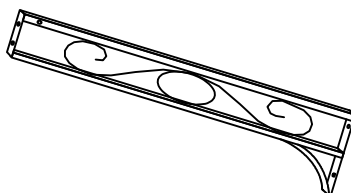

C1 x 1

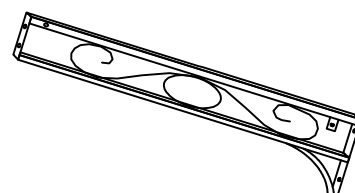

C2 x 1

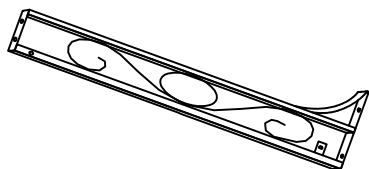

D x 2

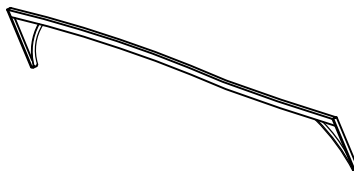

D1 x 2

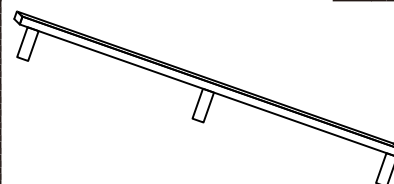

E x 1

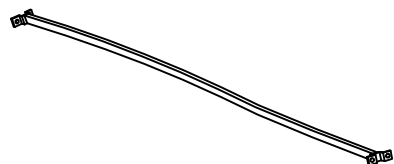

E1 x 2

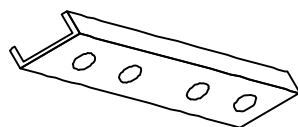

F x 10

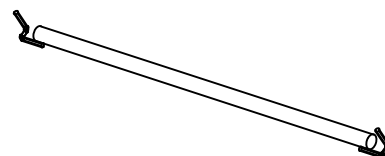

F1 x 3

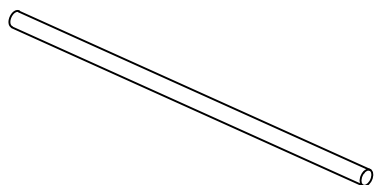

F2 x 3

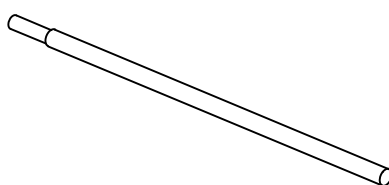

H x 2

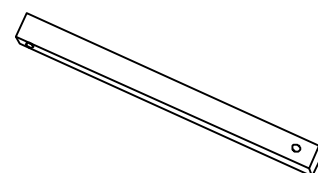

H1 x 2

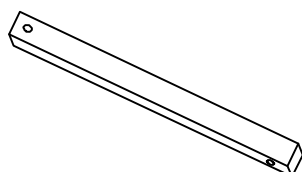

M x 1

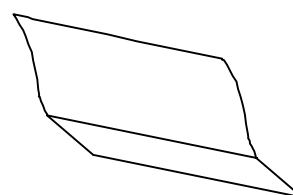

I x 2
M6*40

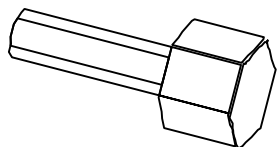

J x 8
M6*50
+1(spare)

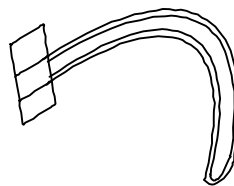

K x 16
M6*30
+1(spare)

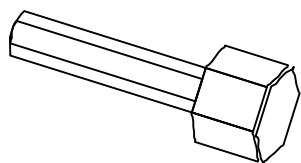

L x 4
M6*15

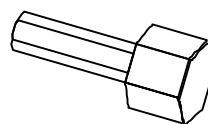

N x 4
M6*50

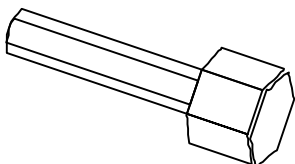

O x 32
+2(spare)

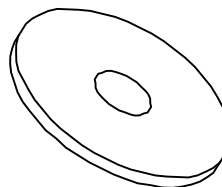

P x 2
+1(spare)

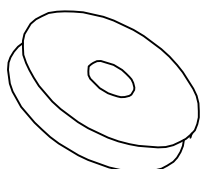

Q x 32
+2(spare)

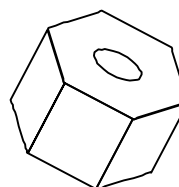

T x 8
+1(spare)

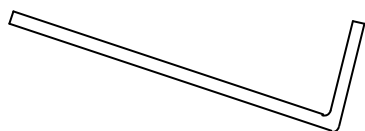

Y x 2

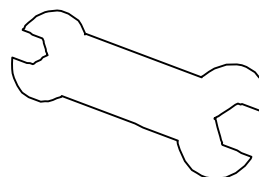

Z x 2

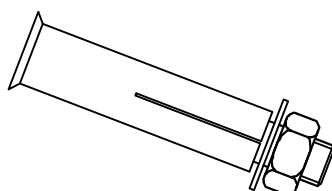

C x 2



E1 x 1

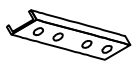

K x 4



M6x30

L x 2



M6x15

O x 6



Q x 6



Y x 2

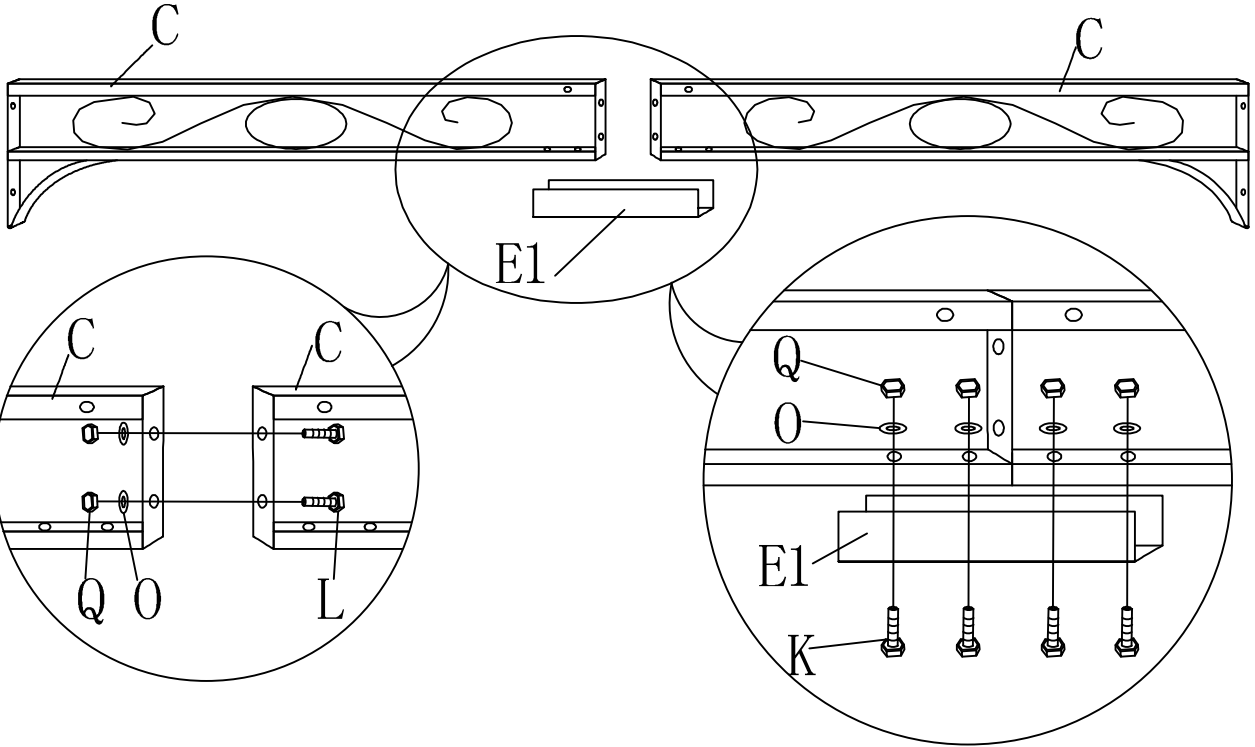

A x 2



A1 x 4



B x 1



B1 x 1



C1 x 1



C2 x 1



D x 2



E x 1



E1 x 1



F x 10



J x 8



M6x50

K x 8



M6x30

L x 2



M6x15

N x 4



M6x50

O x 22



Q x 22



T x 8



Y x 2



Z x 2

