

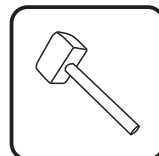

INbfc015V02\_UK\_FR\_US\_CA

845-334V01

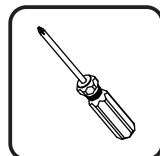
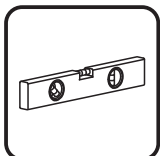
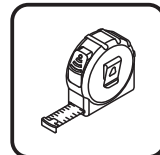
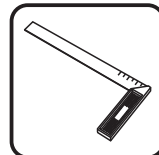
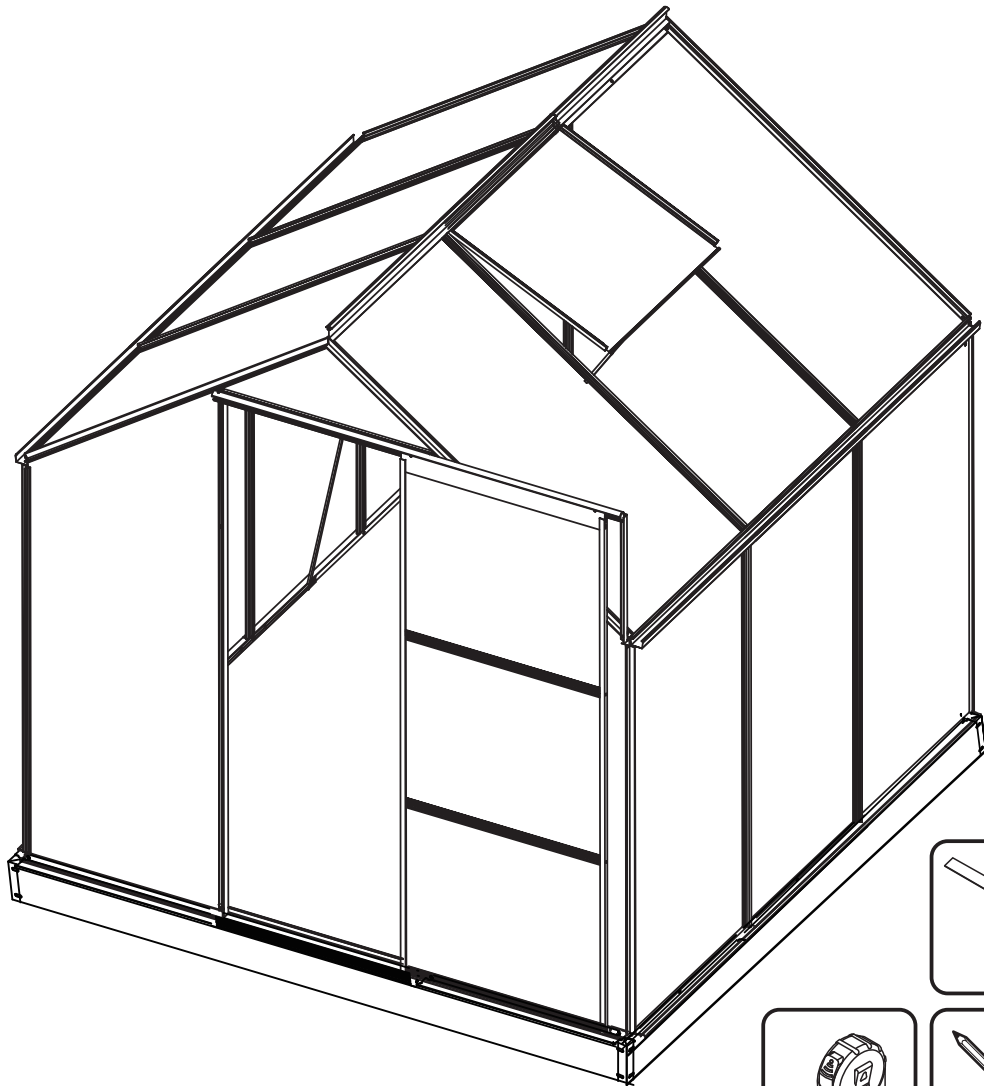

Tools Recommended

**EN\_IMPORTANT, RETAIN FOR FUTURE REFERENCE: READ CAREFULLY.**

**FR\_IMPORTANT: A LIRE ATTENTIVEMENT ET À CONSERVER POUR CONSULTATION ULTÉRIEURE.**















































**ES\_IMPORTANTE, LEA Y GUARDE PARA FUTURAS REFERENCIAS.**

**DE\_WICHTIG! SORGFÄLTIG LESEN UND FÜR SPÄTER NACHSCHLAGEN AUFBEWAHREN.**





**IT\_IMPORTANTE! CONSERVARE IL PRESENTE MANUALE PER FUTURO RIFERIMENTO E LEGGERLO ATTENTAMENTE.**

**PACKING DETAILS:TOTAL 2 BOXES**

**S190-DP      CARTON : 1/2**

PART	NO.	SIZE (mm)	QTY	PART	NO.	SIZE (mm)	QTY	PART	NO.	SIZE (mm)	QTY
	D1	1617	1		D4	1617	1		D2	621	1
	D3	621	3		9L	1641	1		9R	1641	1
	18	1245	1		13	635	1		W1	590	1
	W2	522	2		W3	590	1		W4	380	1
	21	632	1		12	596	2		14	1824	1
	22	1361	4		23	1310	2		7	1215	4
	16-1	1130	1		16-2	1130	1		16-3	1130	1
	16-4	1130	1		10L	1664	1		10R	1664	1
	19	1215	4		20	1113	4		25	396	1
	6	1830	1		5	1830	1		4	1830	2
	8	1830	2		17	1830	1		B3		130
	B4		1		B5		4		B6		1
	B8		1		S3		4		S4		8
	S9		1		S7L		1		S7R		1
	S8		1		F1		11		F3		1
	F4		84		F5		4		F8		1
	F9		1	PANEL	P5	1869x602	1	PANEL	P6L	1655x602	2
PANEL	P6R	1655x602	2	PANEL	P2	547x593	1	PANEL	P1	518x620	3
PANEL	P7	234x623	1	PANEL	P10	585x602	1	PANEL	P9	1127x602	5
PANEL	P8	1213x602	6		MANU AL		1				

**S190-DP      CARTON : 2/2**

PART	NO.	SIZE (mm)	QTY	PART	NO.	SIZE (mm)	QTY	PART	NO.	SIZE (mm)	QTY
	1	1893	4		3	117	4		B2		16
	F4		16								

**TO PREVENT INJURY, READ AND UNDERSTAND THE GREENHOUSE ASSEMBLY INSTRUCTIONS BEFORE USE.**

### **GENERAL SAFETY, WARNINGS AND PRECAUTIONS**

#### **KEEP WORK AREA CLEAN AND DRY.**

Cluttered, damp or wet work areas invite injuries.

**STAY ALERT.** Watch what you are doing at all times. Use common sense. Do not use the greenhouse when you are tired or distracted from the job at hand. It is recommended to use gloves for assembling the greenhouse.

#### **MAINTAIN THIS PRODUCT WITH CARE.**

Keep the greenhouse clean and dry for better performance: maintenance should be performed regularly.

#### **USE THE RIGHT PRODUCT FOR THE JOB.**

Do not attempt to force a small product to do the work of a larger industrial product. There are certain applications for which the greenhouse was designed. It will do the job better and more safely in the manner for which it was intended. Do not modify the greenhouse and do not use the greenhouse for a purpose for which it was not intended.

#### **MAINTAIN A SAFE WORKING ENVIRONMENT.**

Keep the work area tidy. Make sure there is adequate surrounding workspace. Avoid high traffic areas. Always keep the work area free of obstructions, grease, oil, trash and other debris.

#### **PROPER GREENHOUSE LOCATION.**

Make sure the greenhouse is located on a flat level surface.

**POUR ÉVITER LES RISQUES DE BLESSURES, VEILLEZ LIRE ET COMPRENDRE LES INSTRUCTIONS DE MONTAGE DE LA SERRE AVANT DE L'UTILISER.**

### **SÉCURITÉ GÉNÉRALE, AVERTISSEMENTS ET PRÉCAUTIONS**

#### **GARDER LA ZONE DE TRAVAIL PROPRE ET SÈCHE.**

Les zones de travail encombrées, humides ou mouillées sont propices aux blessures.

**RESTEZ VIGILANT.** Surveillez ce que vous faites à tout moment. Faites preuve de bon sens. N'utilisez pas la serre lorsque vous êtes fatigué ou distrait du travail en cours. Il est recommandé d'utiliser des gants pour le montage de la serre.

#### **ENTRETIENEZ CE PRODUIT AVEC SOIN.**

Gardez la serre propre et sèche pour un meilleur rendement : l'entretien doit être effectué régulièrement.

#### **UTILISEZ LE PRODUIT APPROPRIÉ POUR LE TRAVAIL À EFFECTUER.**

N'essayez pas de forcer un petit produit à faire le travail d'un produit industriel plus important. La serre a été conçue pour certaines applications. Elle fera mieux le travail pour lequel elle a été conçue et de manière plus sûre. Ne modifiez pas la serre et n'utilisez pas la serre à des fins pour lesquelles elle n'a pas été conçue.

#### **MAINTENIR UN ENVIRONNEMENT DE TRAVAIL SÛR.**

Maintenez l'espace de travail en ordre. Assurez-vous que l'espace de travail environnant est adéquat. Évitez les zones à forte circulation. Maintenez la zone de travail toujours libre de tout obstacle, graisse, huile, déchets et autres débris.

#### **EMPLACEMENT ADÉQUAT DE LA SERRE.**

Veillez à ce que la serre soit située sur une surface plane et de niveau.

**ES**

**PARA PREVENIR LESIONES, LEA Y COMPRENDA LAS INSTRUCCIONES DE MONTAJE DEL INVERNADERO ANTES DE USARLO.**

## **SEGURIDAD GENERAL, ADVERTENCIAS Y PRECAUCIONES**

### **MANTENGA EL ÁREA DE TRABAJO LIMPIA Y SECA.**

Las áreas de trabajo desordenadas, húmedas o mojadas pueden provocar lesiones.

**MANTÉNGASE ALERTA.** Vigile lo que está haciendo en todo momento con el conocimiento común. No use el invernadero cuando esté cansado o distraído del trabajo en cuestión. Se recomienda utilizar guantes para montar el invernadero.

### **MANTENGA ESTE PRODUCTO CON CUIDADO.**

Mantenga el invernadero limpio y seco para un mejor rendimiento: el mantenimiento debe realizarse con regularidad.

### **USE EL PRODUCTO ADECUADO PARA EL TRABAJO.**

No intente forzar a un producto pequeño a hacer el trabajo que debe hacerse por un producto industrial más grande. Existen determinadas aplicaciones para las que se ha diseñado el invernadero. Puede hacer el trabajo mejor y con más seguridad si se usa en la manera para la que fue diseñado. No modifique el invernadero y no lo utilice para fines para los que no fue diseñado.

### **MANTENGA UN AMBIENTE DE TRABAJO SEGURO.**

Mantenga el área de trabajo ordenada. Asegúrese de que haya un espacio de trabajo circundante adecuado. No lo use en las áreas de mucho tráfico. Mantenga siempre el área de trabajo libre de obstrucciones, grasa, aceite, basura y otros desechos.

### **UBICACIÓN APROPIADA DEL INVERNADERO.**

Asegúrese de que el invernadero esté ubicado en una superficie plana y nivelada.

**DE**

**Um Verletzungen zu vermeiden, lesen und verstehen Sie bitte vor dem Gebrauch die Anweisungen zur Montage des Gewächshauses.**

## **Allgemeine Sicherheit, Warnhinweise und Vorsichtsmaßnahmen**

### **Halten Sie Arbeitsbereich sauber und trocken .**

Überfüllte, feuchte oder nasse Arbeitsbereiche können zu Verletzungen führen.

**WACHSAM BLEIBEN.** Beobachten Sie jederzeit, was Sie tun. Verwenden Sie gesunden Menschenverstand. Verwenden Sie das Gewächshaus nicht, wenn Sie müde oder von der anstehenden Aufgabe abgelenkt sind. Es wird empfohlen, für die Montage des Gewächshauses Handschuhe zu tragen.

### **Behalten Sie dieses Produkt mit Pflege**

Halten Sie das Gewächshaus sauber und trocken, um eine bessere Leistung zu erzielen: Regelmäßige Wartungsarbeiten sollten durchgeführt werden.

### **Verwenden Sie das richtige Produkt für den Job**

Versuchen Sie nicht, ein kleines Produkt zu zwingen, die Arbeit eines größeren Industrieprodukts zu erledigen. Es gibt bestimmte Anwendungen, für die das Gewächshaus konzipiert wurde. Es wird die Arbeit besser und sicherer in der Weise erledigen, für die es bestimmt war. Ändern Sie das Gewächshaus nicht und verwenden Sie es nicht für Zwecke, für die es nicht vorgesehen war.

### **Sorgen Sie für ein sicheres Arbeitsumfeld.**

Halten Sie den Arbeitsbereich sauber und ordentlich. Stellen Sie sicher, dass Sie genügend Arbeitsfläche um sich haben. Vermeiden Sie stark frequentierte Bereiche. Halten Sie den Arbeitsbereich immer frei von Hindernissen, Fett, Öl, Müll und anderen Fremdkörpern.

### **Richtige Gewächshauslage.**

Stellen Sie sicher, dass sich das Gewächshaus auf einer ebenen Fläche befindet.

**PER PREVENIRE LESIONI, LEGGETE E COMPRENDETE LE ISTRUZIONI DI ASSEMBLAGGIO DELLA SERRA PRIMA DELL'USO.**

## **SICUREZZA GENERALE, AVVERTENZE E PRECAUZIONI**

### **MANTENETE L'AREA DI LAVORO PULITA E ASCIUTTA.**

Le aree di lavoro disordinate, umide o bagnate potrebbero provocare lesioni. **STAI ATTENTO.** Stai attento su cosa stai facendo in ogni momento. Usa il senso comune e non usare la serra quando sei stanco o distratto nel lavoro da svolgere. Si consiglia di utilizzare i guanti per l'assemblaggio della serra.

### **MANTENETE QUESTO PRODOTTO CON CURA.**

Mantieni la serra pulita e asciutta per prestazioni migliori: la manutenzione deve essere eseguita regolarmente.

### **UTILIZZATE IL PRODOTTO GIUSTO PER IL LAVORO.**

Non tentare di forzare un prodotto piccolo a svolgere un lavoro di un prodotto industriale più grande. Ci sono alcune applicazioni per le quali il prodotto è stato progettato. Il prodotto funzionerà meglio e più sicuro nel modo per cui è stato progettato. Non modificare la serra e non utilizzare la serra per scopi per i quali non è stata concepita.

### **MANTENETE UN AMBIENTE DI LAVORO SICURO.**

Tieni in ordine l'area di lavoro. Assicurati che ci sia uno spazio di lavoro circostante adeguato. Evita le zone di molto traffico. Mantieni sempre l'area di lavoro libera da ostruzioni, grasso, olio, rifiuti e altri detriti.

### **POSIZIONE ADEGUATA DELLA SERRA.**

Assicurati che la serra si trovi su una superficie piana e livellata.

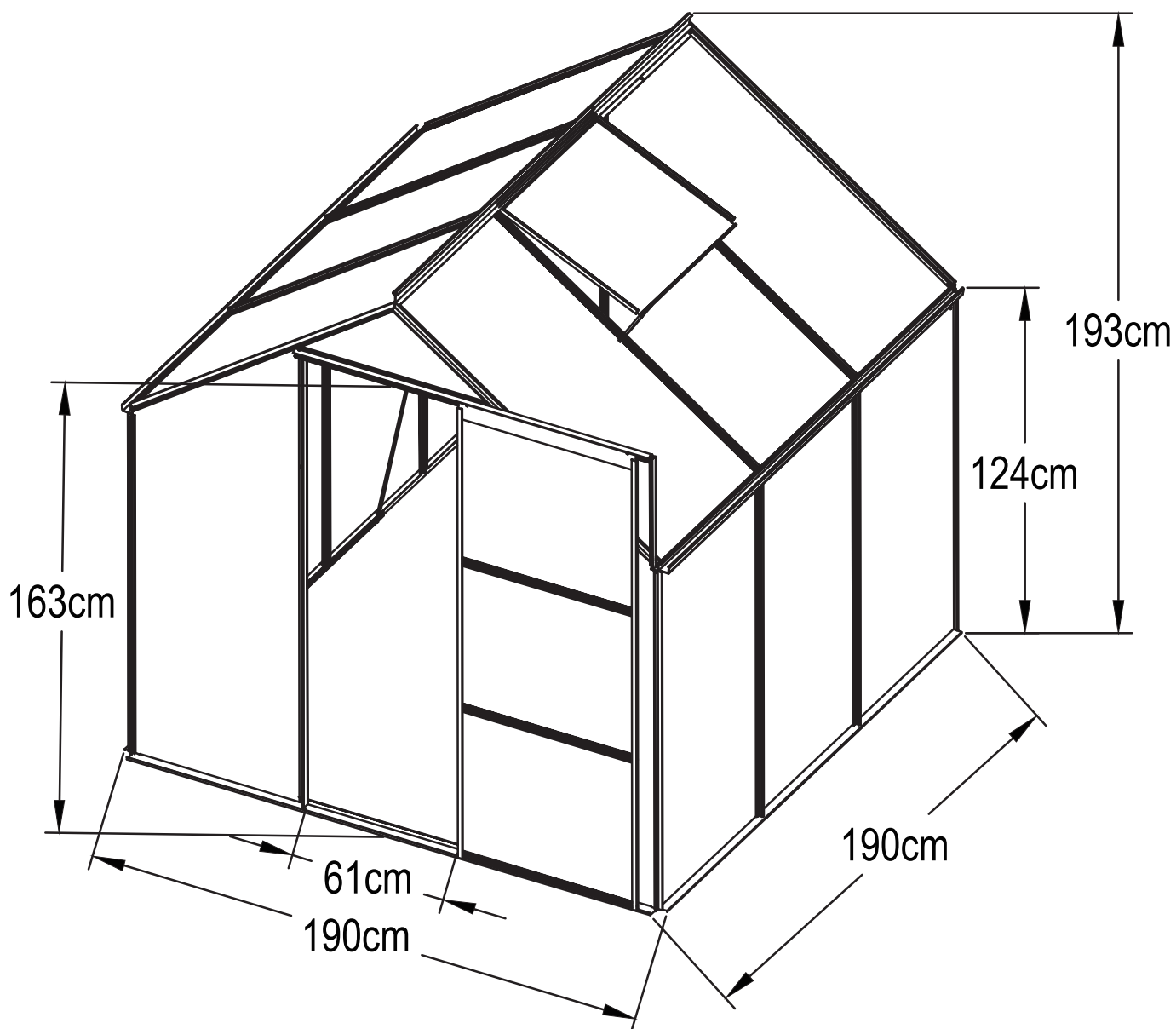

**EN** If you meet some difficult during the assembly, please loosen the relevant screws for adjustment first, and then tighten the screws again.

**FR** Si vous rencontrez des difficultés lors du montage, veuillez d'abord desserrer les vis correspondantes pour les ajustements, puis les resserrer.

**ES** Si encuentra alguna dificultad durante el montaje, primero afloje los tornillos correspondientes para ajustar, y luego vuelva a apretarlos.

**DE** Wenn Sie während der Montage auf Schwierigkeiten stoßen, lösen Sie bitte zuerst die entsprechenden Schrauben zur Einstellung und ziehen Sie die Schrauben dann wieder fest.

**IT** In caso di difficoltà durante il montaggio, allentare innanzitutto le viti prima della regolazione, quindi stringere nuovamente le viti.

		<b>EN_DOOR FR_PORTE</b>	
NO.	Qty.		
D1	1		
D4	1		1617mm
D2	1		621mm
D3	3		621mm
13	1		635mm
18	1		1245mm
9L	1		1641mm
9R	1		1641mm
		<b>EN_WINDOW FR_LA FENÊTRE</b>	
W1	1		590mm
W2	2		522mm
W3	1		590mm
W4	1		380mm
S8	1		
S9	1		
21	1		632mm

		<b>EN_walls and roof FR_murs et toit</b>	
NO.	Qty.		
12	2		596mm
14	1		1824mm
22	4		1361mm
23	2		1310mm
7	4		1215mm
16-1	1		1130mm
16-2	1		1130mm
16-3	1		1130mm
16-4	1		1130mm
10L	1		1664mm
10R	1		1664mm
19	4		1215mm
20	4		1113mm
25	1		396mm
6	1		1830mm
5	1		1830mm
4	2		1830mm

		<b>EN_walls and roof FR_murs et toit</b>	
NO.	Qty.		
8	2		1830mm
17	1		1830mm
		<b>EN_other FR_autre</b>	
NO.	Qty.		
B3	130		
B4	1		
B5	4		
B6	1		
B8	1		
S3	4		
S4	8		
S7L	1		
S7R	1		
F1	10		4-9mm
F3	1		5-35mm
F4	79		6-10mm
F5	4		5-10mm
F8	1		4-12mm
F9	1		4-18mm

**EN\_summary statement for polycarbonate panel  
FR\_relevé récapitulatif pour panneau en polycarbonate**

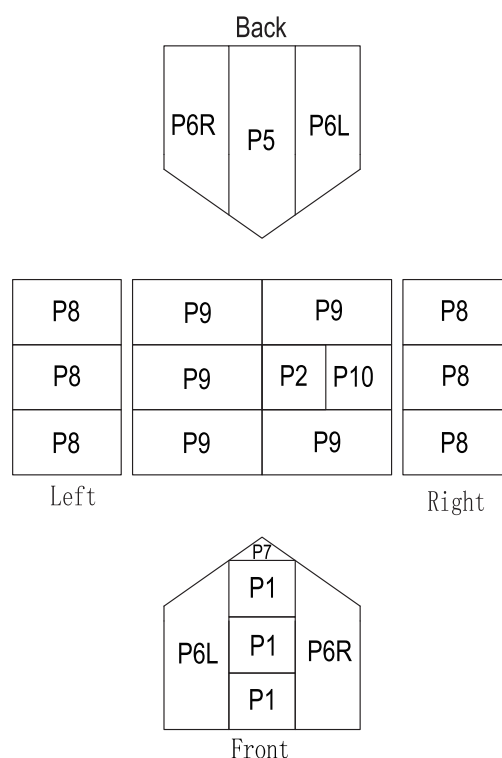

EN\_DOOR  
FR\_PORTE

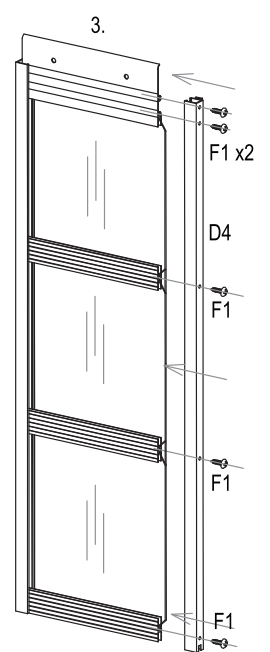
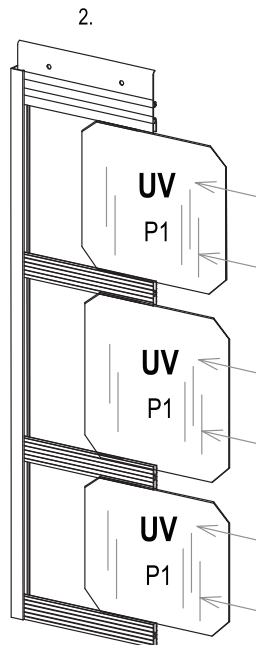
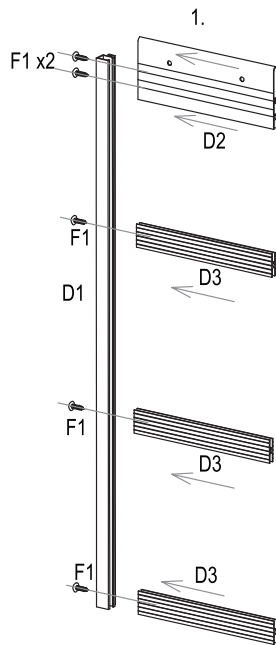
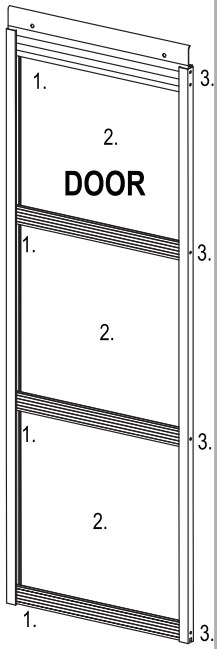
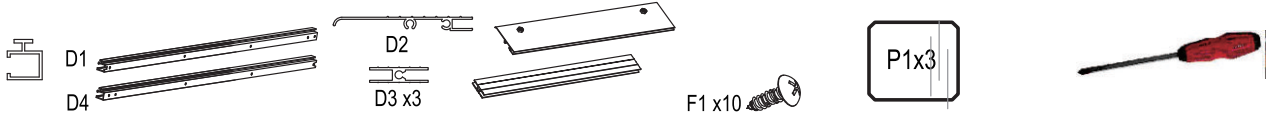

EN\_WINDOW  
FR\_LA FENÊTRE

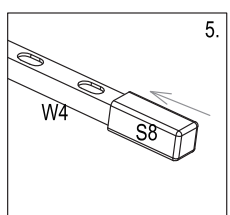
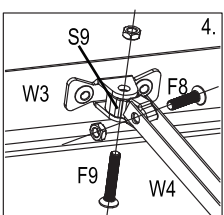
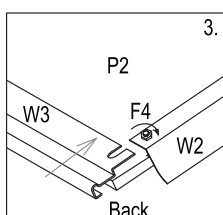
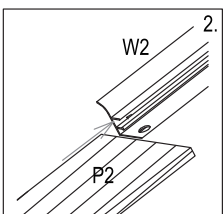
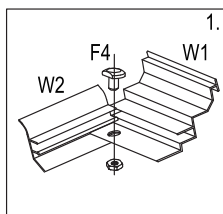
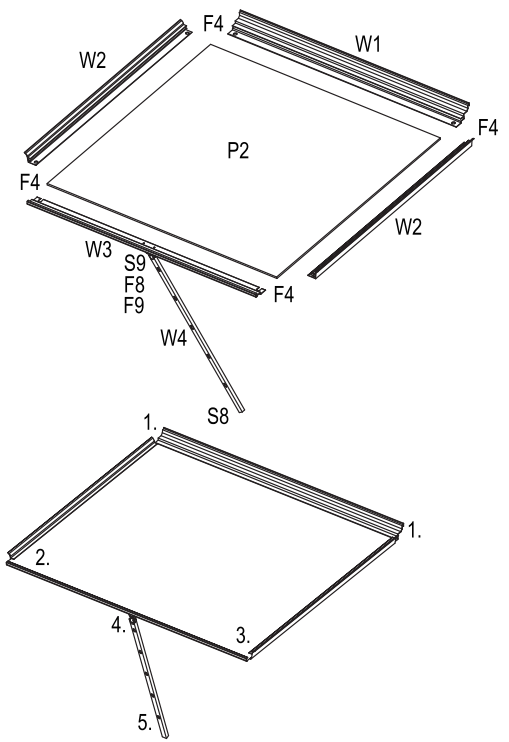
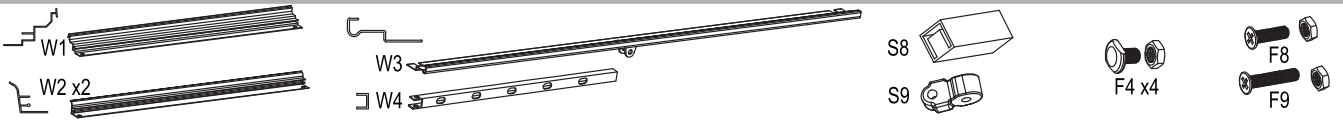





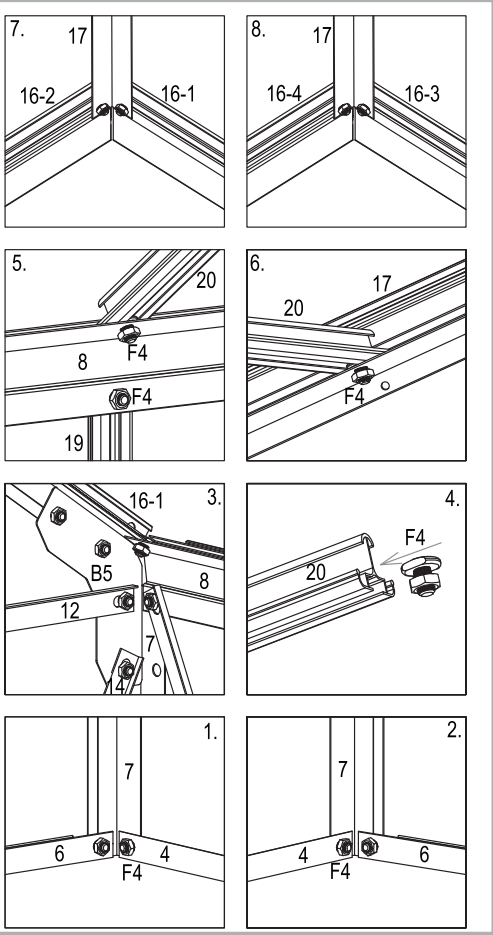
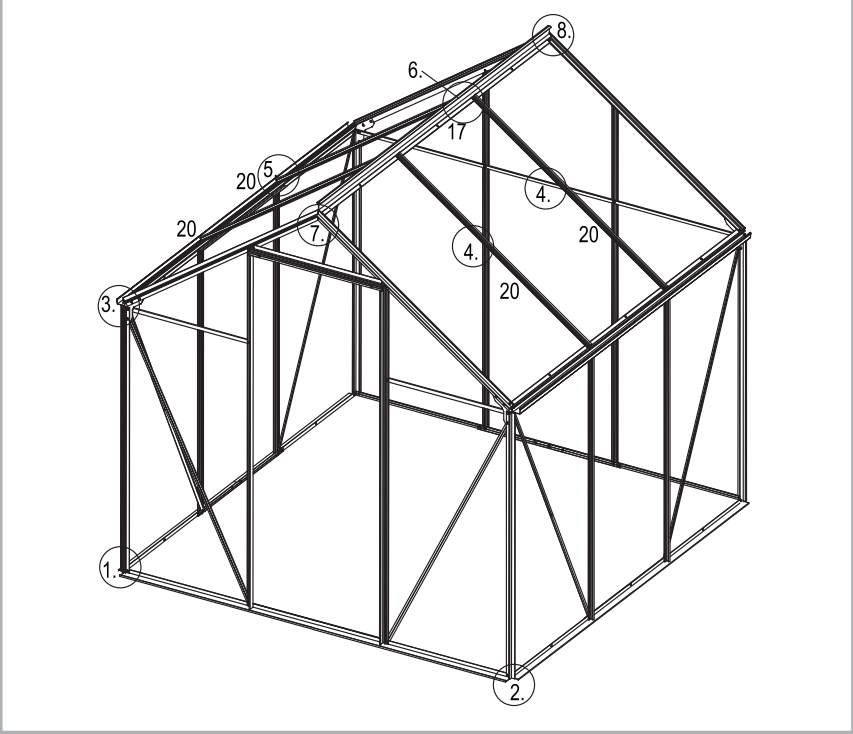
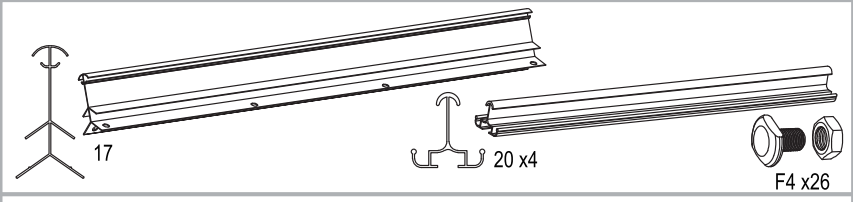
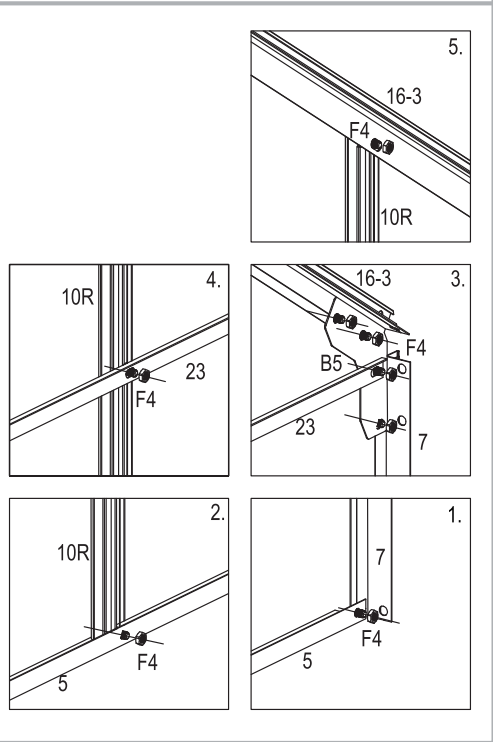
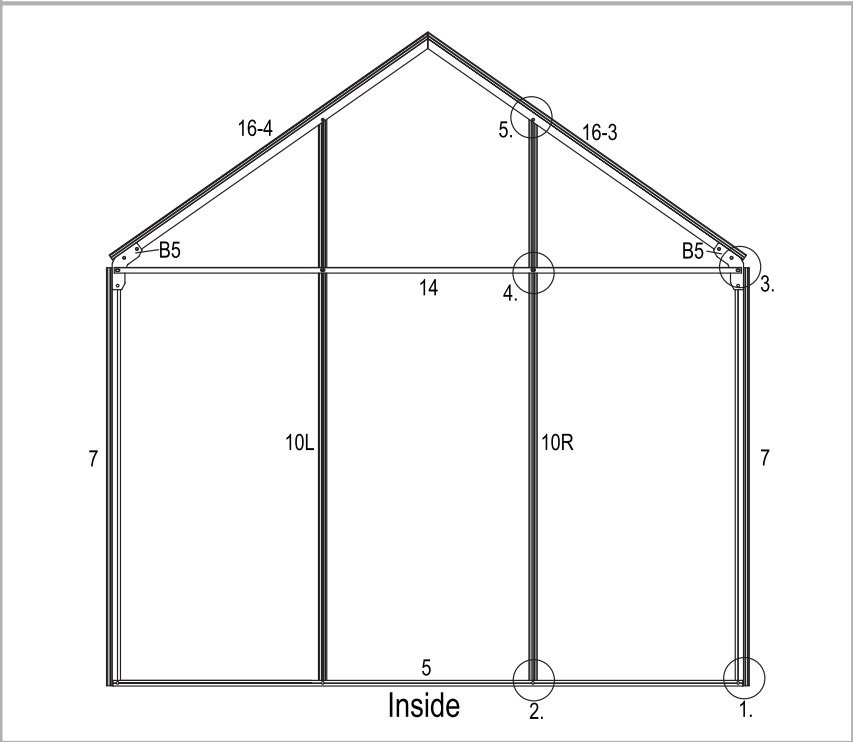
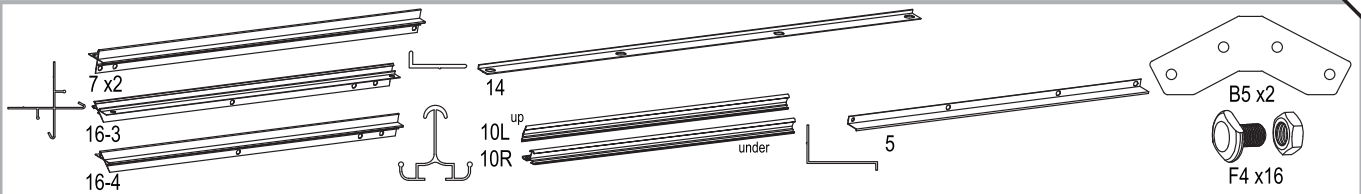

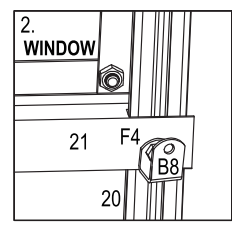
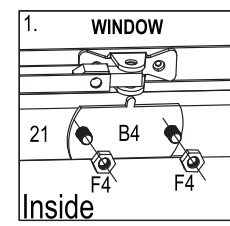
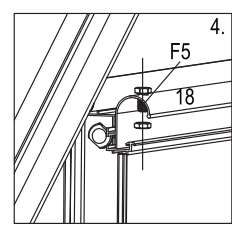
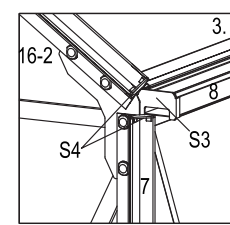
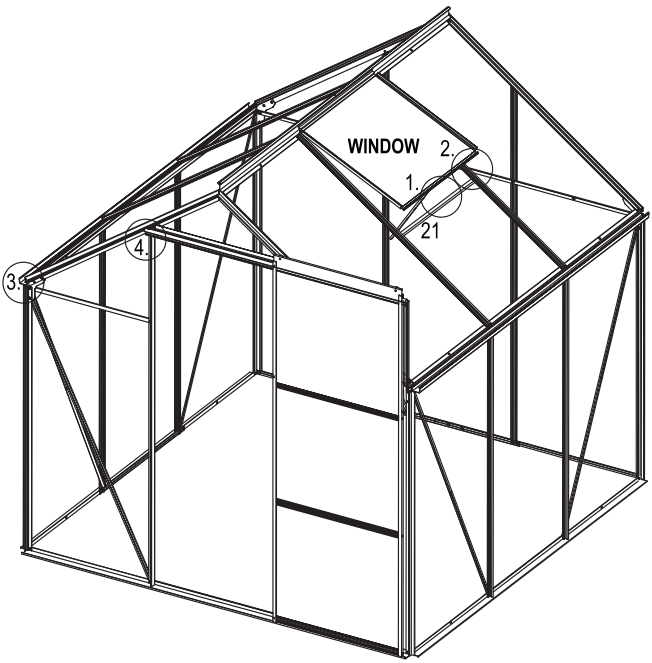
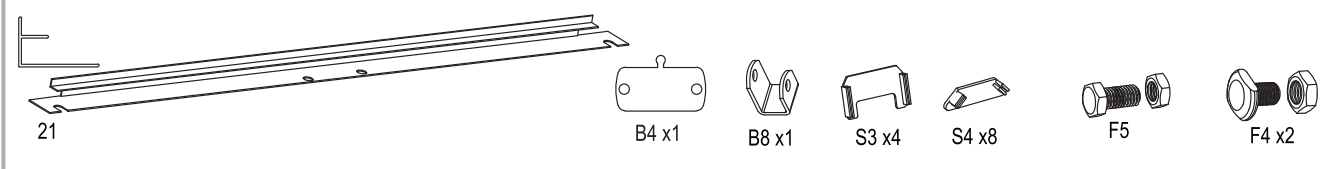
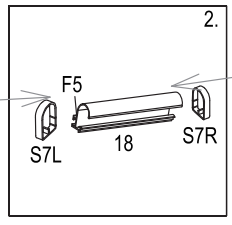
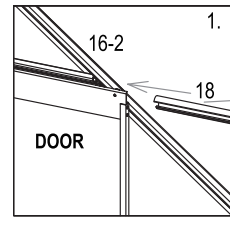
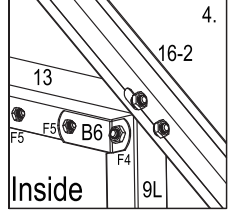
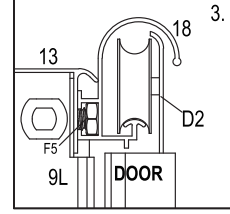
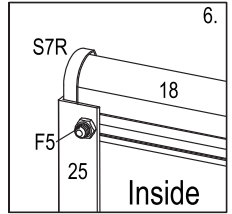
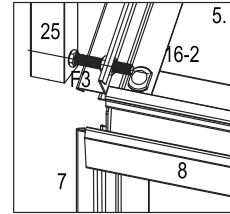
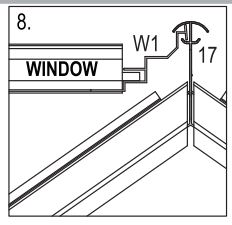
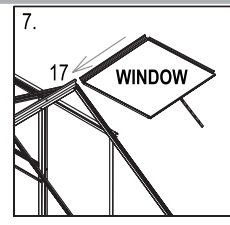
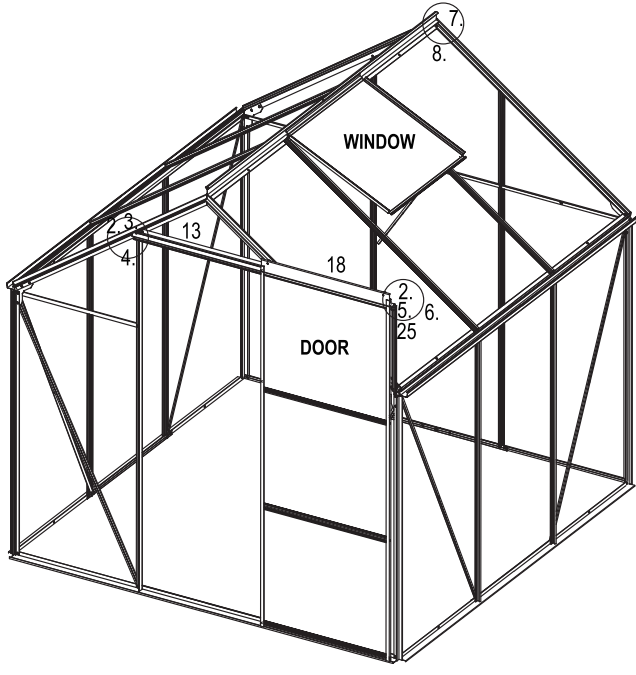
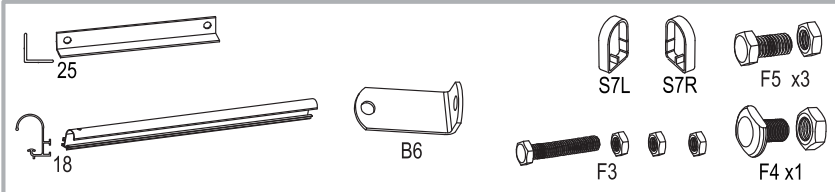

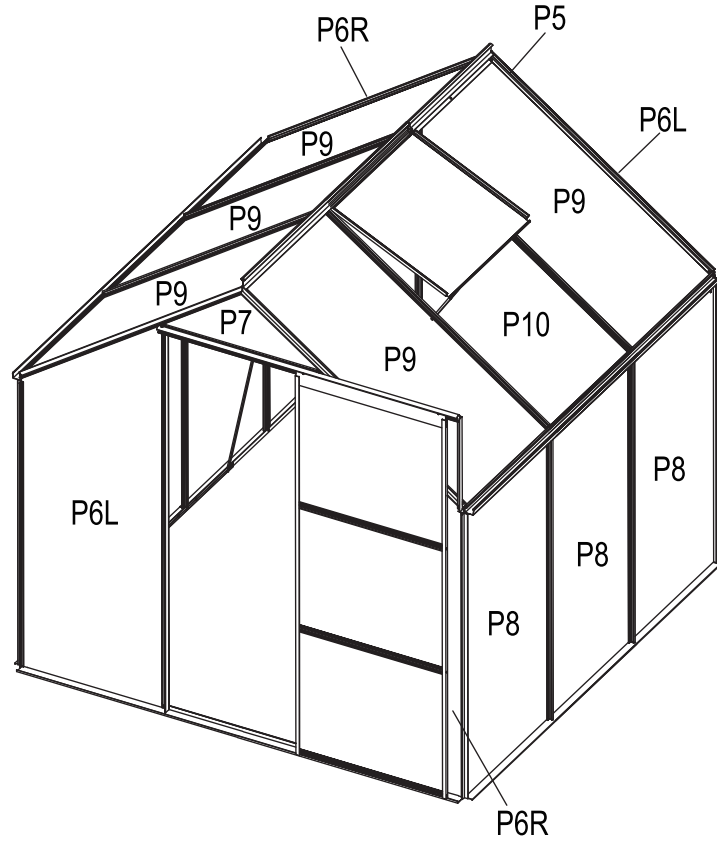

**EN**\_Opal white film  
**FR**\_Film blanc opale

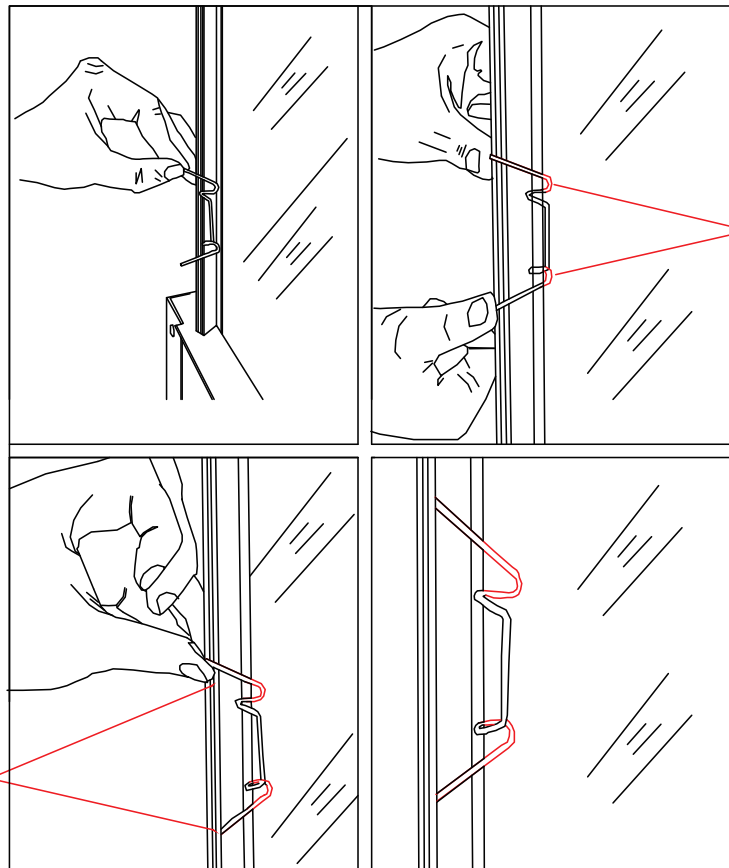
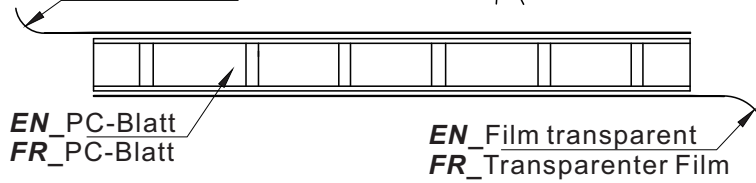
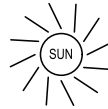

**EN**\_use the "B3" clip to buckle the PC sheet with the profile like this  
**FR**\_utilisez le clip "B3" pour boucler la feuille PC avec le profil comme celui-ci

**EN**\_make one end of the clip into the groove and make it support to the profile, then force the other end make the clip tensional, put the other end into the groove.

**FR**\_insérez une extrémité du clip dans la rainure et faites-le appuyer sur le profil, puis forcez l'autre extrémité à mettre le clip sous tension, placez l'autre extrémité dans la rainure.

## BASE

**EN** Attention before installing metal base

1. The place which the metal base installed is the location which the greenhouse's final installation, must be according to the desired location to install. It is very difficult to install again.
2. The Installation location must away from the underground and aerial cables.
3. The Installation location must away from the cross wind, leaves, climbing plants.

**FR** Attention avant d'installer la base métallique 1. L'endroit où la base métallique installée est l'emplacement où l'installation finale de la serre doit être conforme à l'emplacement souhaité pour l'installation. C'est très difficile à réinstaller. 2. L'emplacement de l'installation doit être éloigné des câbles souterrains et aériens. 3. L'emplacement d'installation doit être éloigné du vent de travers, des feuilles et des plantes grimpantes.

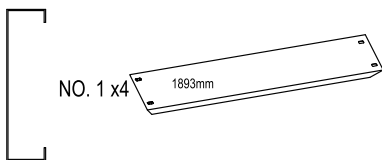
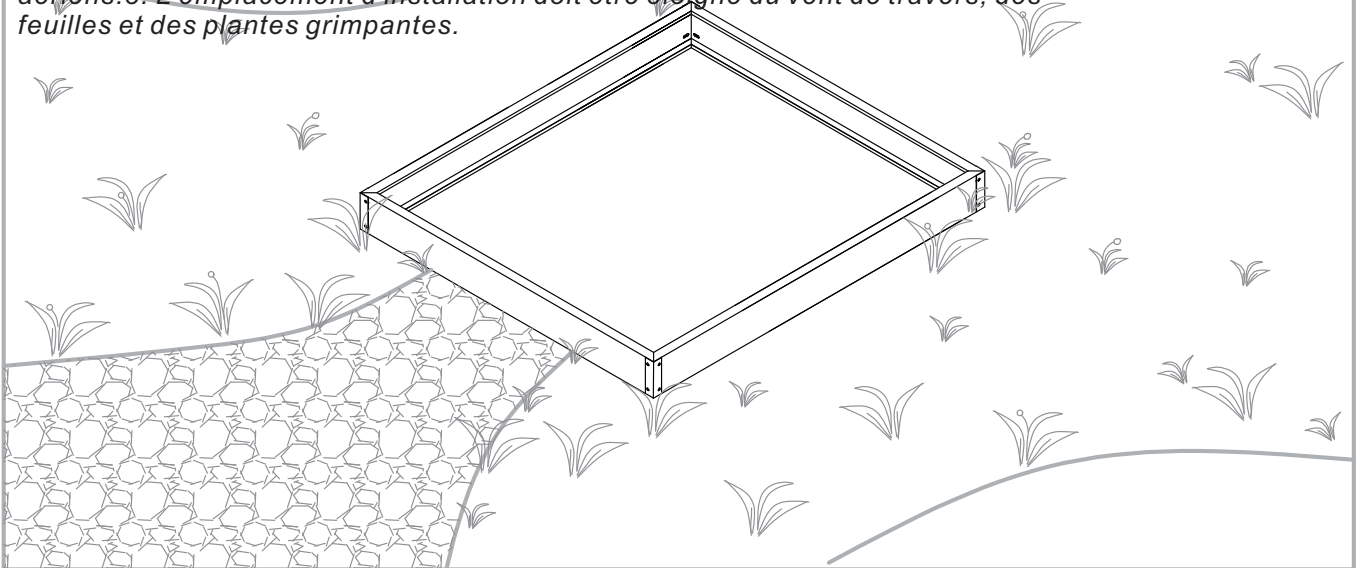

NO. 3 x4

NO. F4 x16

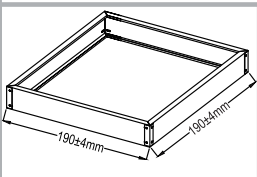

**EN** After assembling, Please make sure Part No. 1 and No.1 keep plumb. All the anchor No.3 is buried into ground. Keep Part No. 1 and No.1 level.

**FR** Après l'assemblage, veuillez vous assurer que les pièces n° 1 et n° 1 restent d'aplomb. Tout l'ancrage n° 3 est enterré dans le sol. Maintenez les pièces n° 1 et n° 1 au niveau.

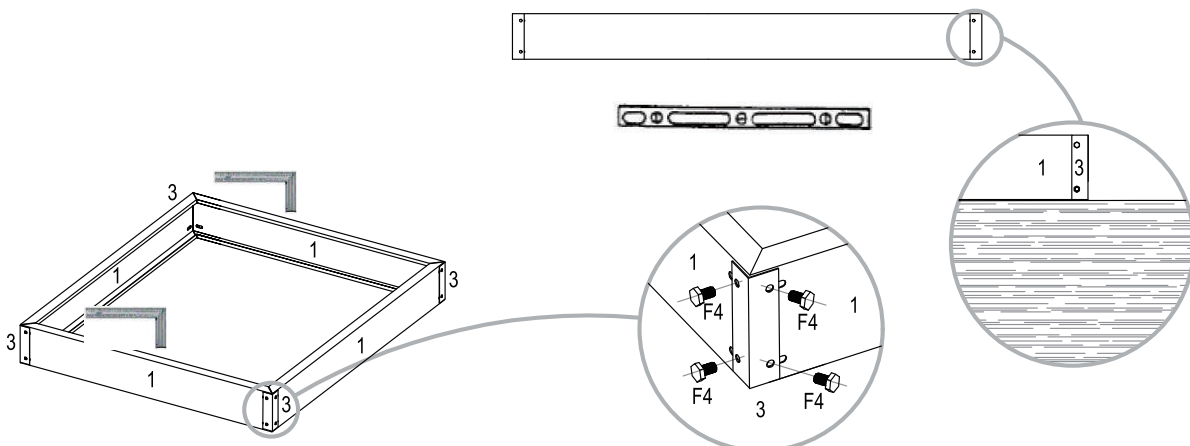

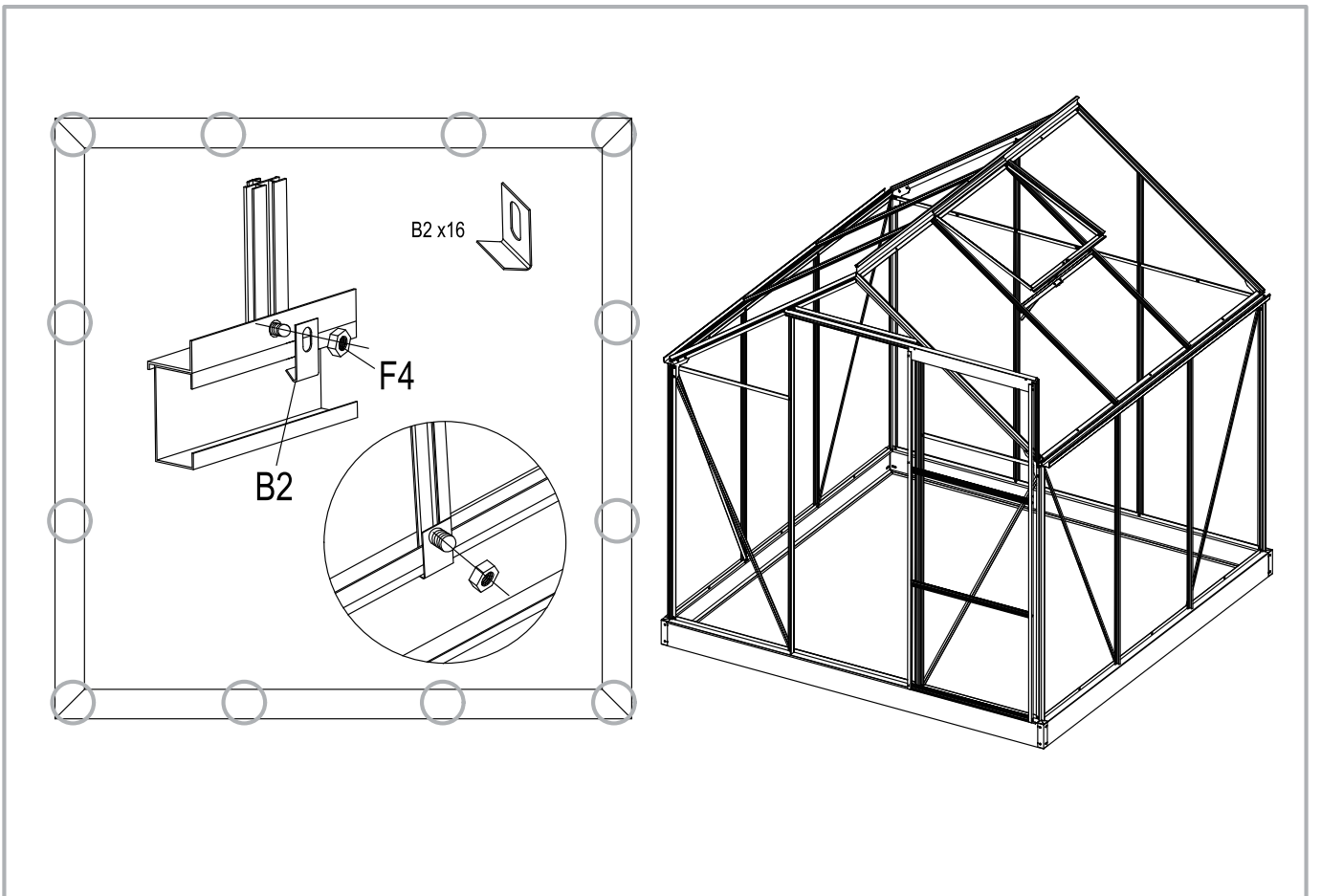
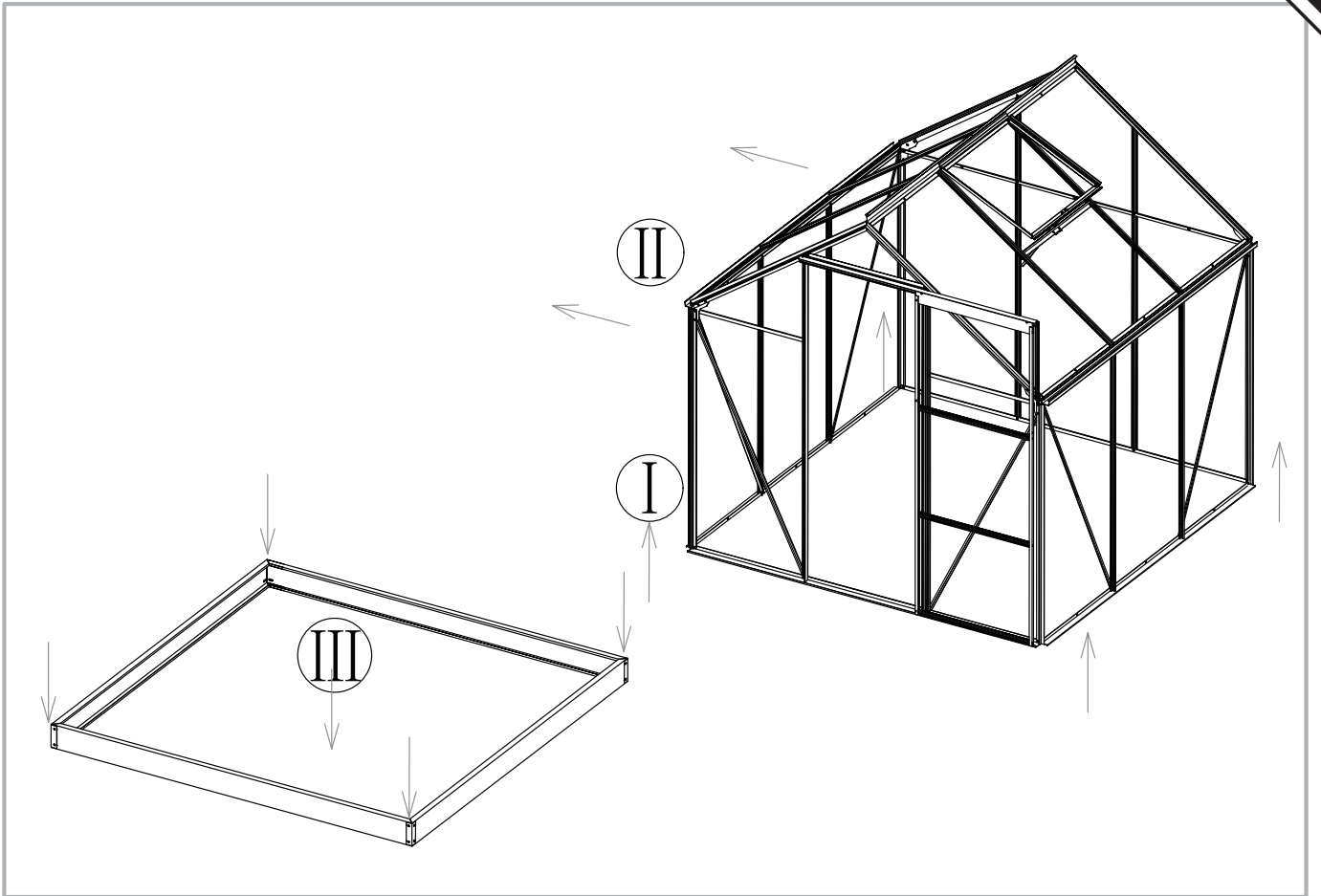

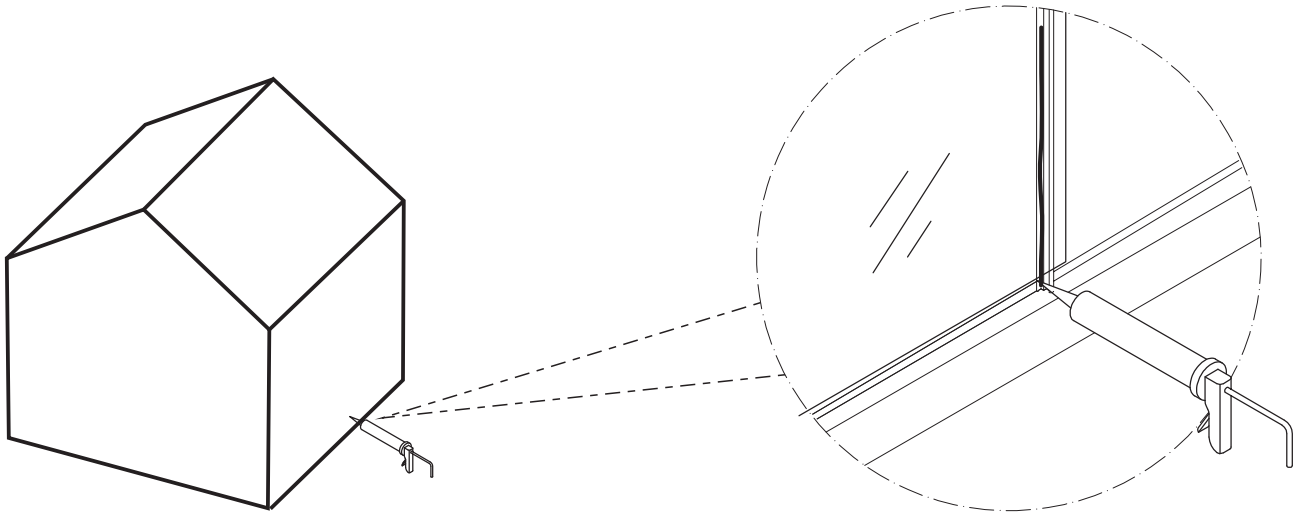

### **EN\_ADVICE**

It is not necessary but we would advise: For additional strength, you can also use some glue or tapes between the polycarbonate panel and the aluminium frame to enhance the stability.

Note: Silicone sealant and glue gun are not included in our tool kit. You can buy them locally. Only use silicone sealant suitable for aluminium

### **FR\_CONSEILS**

Ce n'est pas nécessaire mais nous vous conseillons:

Pour plus de solidité, vous pouvez également utiliser de la colle ou des rubans adhésifs entre le panneau en polycarbonate et le cadre en aluminium pour améliorer la stabilité.

Not : Le mastic silicone et le pistolet à colle ne sont pas inclus dans notre kit d'outils. Vous pouvez les acheter sur place. N'utilisez que du mastic silicone adapté à l'aluminium

### **ES\_CONSEJO**

No es necesario, pero le aconsejamos: Para mayor resistencia, también puede usar pegamento o cintas entre el panel de policarbonato y el marco de aluminio para mejorar la estabilidad.

Nota: El sellador de silicona y la pistola de pegamento no están incluidos en nuestro kit de herramientas. Puede comprarlos localmente. Sólo utilice el sellador de silicona adecuado para aluminio

### **DE\_RAT**

Es ist nicht notwendig, aber wir würden vorschlagen: Um die Festigkeit zu erhöhen, können Sie auch etwas Kleber oder Klebeband zwischen der Polycarbonatplatte und dem Aluminiumrahmen verwenden, um die Stabilität zu verbessern.

Hinweis: Silikonichtmittel und Klebepistole sind nicht in unserem Werkzeugsatz enthalten. Sie können sie vor Ort kaufen. Verwenden Sie nur für Aluminium geeignetes Silikonichtmittel

### **IT\_SUGGERIMENTI**

Non è necessario ma consigliamo: Per una maggiore resistenza, puoi anche usare della colla o dei nastri tra il pannello in polycarbonato e la struttura in alluminio per migliorare la stabilità.

Nota: il sigillante siliconico e la pistola per colla non sono inclusi nel nostro kit di attrezzi.

Puoi acquistarli localmente. Utilizzare solo sigillante siliconico adatto per alluminio.

**EN\_It is not necessary but we would advise:**

For additional strength, especially in the area with the strong wind weather, you can also drill the screws between the polycarbonate and the aluminum frame to enhance the stability.

**FR\_Ce n'est pas nécessaire mais nous vous conseillons:**

Pour plus de solidité, en particulier dans les zones où le vent est fort, vous pouvez également percer les vis entre le polycarbonate et le cadre en aluminium pour améliorer la stabilité.

**ES\_No es necesario, pero le aconsejamos:**

Para mayor resistencia, especialmente en el área con viento fuerte, también puede perforar los tornillos entre el policarbonato y el marco de aluminio para mejorar la estabilidad.

**DE\_Es ist nicht notwendig, aber wir würden vorschlagen:**

Um die Festigkeit zu erhöhen, insbesondere in Gebieten mit starkem Wind, können Sie auch die Schrauben zwischen dem Polycarbonat und dem Aluminiumrahmen bohren, um die Stabilität zu verbessern.

**IT\_Non è necessario ma consigliamo:**

Per una maggiore resistenza, soprattutto nella zona con vento forte, potete forare e serrare le viti tra il policarbonato e la struttura in alluminio per migliorare la stabilità.