

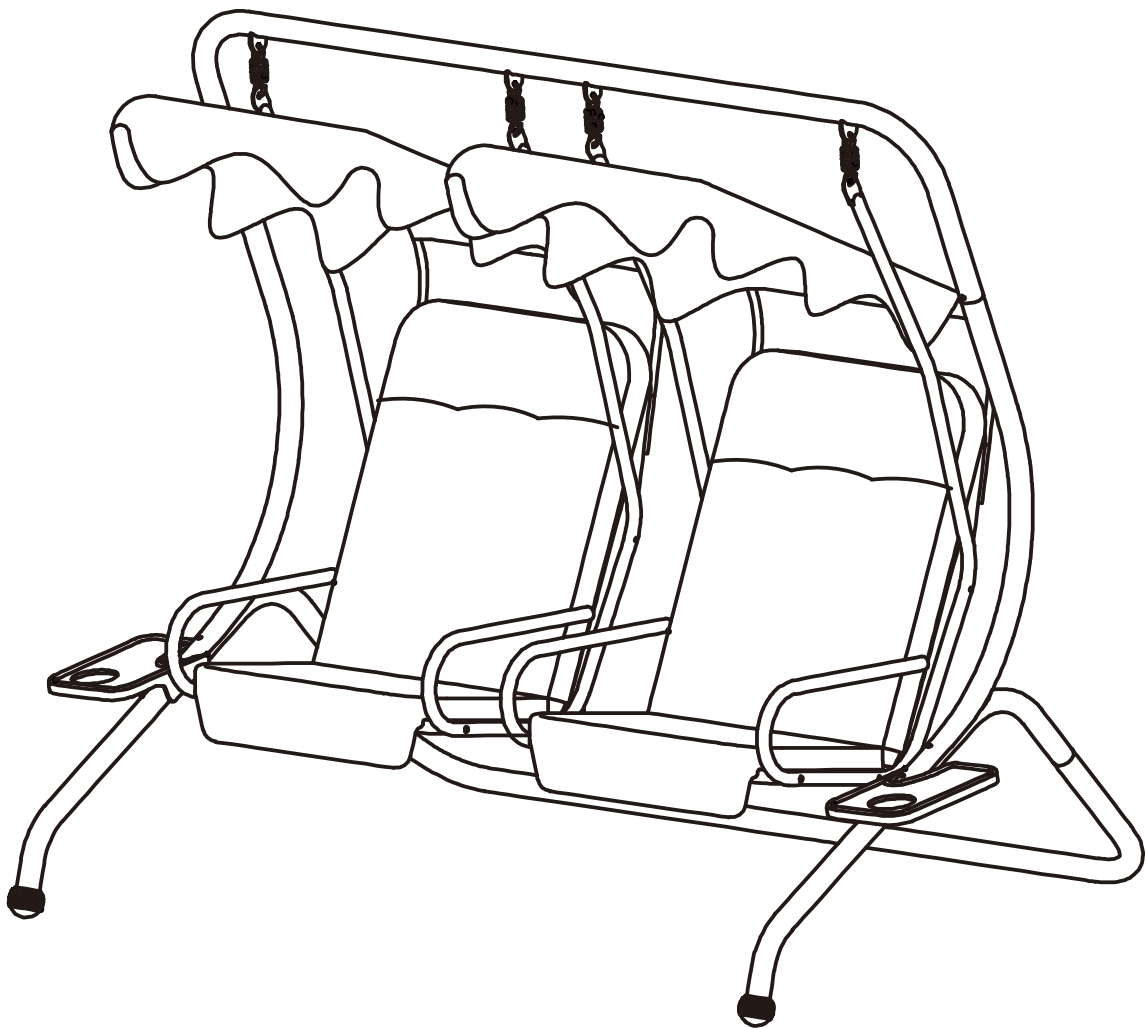

INbia005V04_UK_FR_ES_DE_IT

01-0882_84A-052V71



IMPORTANT, RETAIN FOR FUTURE REFERENCE: READ CAREFULLY

ASSEMBLY & INSTRUCTION MANUAL

Garden swing

IMPORTANT, RETAIN FOR FUTURE REFERENCE: READ CAREFULLY

Only for domestic use

Use tips:

- *Put the swing stably on a flat floor.
- *Mount the swing arm in the shelter of the weather.
- *Stay away from open flames.
- *Don't hang anything in the structure.
- *Avoid the overload at the anchors.
- *It is advised that don't stay on the swing when there is a storm.
- *It is recommended to protect in case of strong wind or rain and in your absence.

Precautions before assembly:

- *Prepare a clean and dry mounting area.
- *Verify that the product is not damaged.
- *Check that none of the pieces are missing.

Maintenance:

- *Clean with a soft fabric.
- *Regularly remove leaves and / or water collected on the canvas.
- *Check the anchors regularly.

Storage conditions:

*The fabric should be stored completely dry, in a clean and dry place to avoid the risks of mold.

Caution with the risks of pinching or cuts during assembly.

The manufacturer declines all responsibility in case of damages due to a bad installation or due to weather.

Importer

MH STAR UK LTD
Unit 7, Perivale Park,
Horsenden lane South
Perivale, UB6 7RH
<https://www.aosom.co.uk>
Made in China

Balançoire de jardin

IMPORTANT - CONSERVEZ CES INFORMATIONS POUR VOTRE CONSULTATION ULTÉRIEURE: LISEZ ATTENTIVEMENT

Seulement pour usage domestique

Conseils :

- * Placez la balançoire de manière stable sur un sol plat.
- * Montez le bras pivotant à l'abri des intempéries.
- * Restez à l'écart des flammes ouvertes.
- * Ne rien accrocher dans la structure.
- * Évitez la surcharge aux extrémités de la structure.
- * Il est conseillé de ne pas rester sur la balançoire en cas d'orage.
- * Il est recommandé de la protéger en cas de vent fort ou de pluie et en votre absence.

Précautions avant l'assemblage:

- * Préparez une zone de montage propre et sèche.
- * Vérifiez que le produit n'est pas endommagé.
- * Vérifiez qu'aucun des morceaux ne manque.

Recommandations d'entretien:

- * Veuillez utiliser un chiffon doux pour essuyer la chaise.
- * Veuillez nettoyer régulièrement l'eau stagnante du fauteuil
- * Veuillez vérifier régulièrement la chaise pour éviter une structure lâche.

Conditions de stockage:

- * Veuillez stocker le produit dans un environnement propre et sec pour éviter tout risque de moisissure.

Veillez faire attention à ne pas être pris ou rayé par le produit lors de l'assemblage

Le fabricant n'est pas responsable des dommages causés par une mauvaise installation.

Si le fauteuil est équipé d'un dispositif de hauteur réglable avec accumulateur, seul une personne qualifiée peut remplacer ou réparer la partie de hauteur réglable du siège.

Importateur:

MH FRANCE

2 Rue Maurice Hartmann
92130 Issy Les Moulineaux

France

<https://www.aosom.fr>

Fabriqué en Chine

Columpio Balancín Jardín

IMPORTANTE-CONSERVE ESTA INFORMACIÓN PARA SU CONSULTA POSTERIOR: LEER DETALLA DAMENTE

Solamente para uso doméstico

Consejos de uso:

- *Coloque el balancín de forma estable sobre un suelo plano.
- *Montar el balancín al abrigo de la intemperie.
- *Manténgase alejado de llamas abiertas.
- *No cuelgue nada en la estructura.
- *Envite la sobrecarga en los anclajes.
- *Se aconseja no permanecer en el balancín cuando hay tormenta.
- *Se recomienda resguardar en caso de viento o lluvia fuerte y en su ausencia.

Precauciones antes del montaje:

- *Prepare una zona de montaje limpia y seca.
- *Verificar que el producto no este dañado.
- *Controlar que no falta ninguna de las piezas.

Mantenimiento:

- *Limpiar con la ayuda de un paño suave.
- *Eliminar regularmente las hojas y/o agua recogidas sobre la lona.
- *Compruebe regularmente los anclase.

Condiciones de almacenaje:

- *La tela debe ser guardada totalmente seca, en un lugar limpio y seco para evitar los riesgos de moho.

Precaución con los riesgos de pinzamientos o cortes durante el montaje.

El fabricante declina toda responsabilidad en caso de deterioros debidos a una mala instalación o por causas meteorológicas.

IMPORTADOR POR:

SPANISH AOSOM, S.L.
C. roc gros no. 15
08550 Els hostalets de Balenya
Spain B66295775
TEL: 931294512
www.aosom.es
atencioncliente@aosom.es
Fabricado en China

Gartenschaukel

WICHTIG – BITTE HEBEN SIE DIESE ANLEITUNG FÜR EINE SPÄTERE BEZUGNAHME AUF: SORGFÄLTIG DURCHLESEN

Nur für den häuslichen Gebrauch bestimmt

Nutzungshinweise:

- * Bitte stellen Sie die Schaukel stabil auf eine ebene Fläche.
- * Montieren Sie die Schaukel wettergeschützt.
- * Von offenen Feuerquellen fernhalten.
- * Hängen Sie nichts an die Struktur.
- * Vermeiden Sie eine Überlastung der Anker.
- * Es wird empfohlen, die Schaukel bei schlechten Wetterbedingungen nicht zu benutzen.
- * Es wird empfohlen, die Schaukel während Ihrer Abwesenheit vor starkem Regen oder starkem Wind zu schützen.

Vorsichtsmaßnahmen vor der Montage:

- * Bitte bereiten Sie einen sauberen und trockenen Montagebereich vor.
- * Stellen Sie sicher, dass das Produkt nicht beschädigt ist.
- * Vergewissern Sie sich, dass keines der Zubehörteile fehlt.

Instandhaltung:

- * Bitte reinigen Sie die Schaukel nur mit einem weichen Tuch.
- * Bitte entfernen Sie regelmäßig alle Blätter und / oder Wasser, die sich auf dem Stoff angesammelt haben.
- * Bitte überprüfen Sie regelmäßig die Anker.

Lagerung:

- * Der Stoff sollte an einem völlig trockenen und sauberen Ort aufbewahrt werden, um Schimmel zu vermeiden.

Vorsicht vor Quetsch- und Schnittgefahr bei der Montage.

Der Hersteller lehnt jede Haftung für Schäden ab, die durch unsachgemäße Installation oder Witterungseinflüsse verursacht wurden.

Importeur :

MH Handel GmbH
Wendenstraße 309
D-20537 Hamburg
Germany
<https://www.aosom.de>
Hergestellt in China

Altalena da giardino

IMPORTANTE-CONSERVARE QUESTE INFORMAZIONI PER CONSULTARLE IN SEGUITO: LEGGERE ATTENTAMENTE

Solo per uso domestico

Consigli per l'uso:

- *Posizionare l'altalena saldamente su una superficie piana.
- *Montarla in un luogo riparato dalle intemperie del clima.
- *Tenere lontano dal fuoco.
- *Non appendere alcun oggetto alla struttura.
- *Evitare di sovraccaricare le giunture.
- *E' consigliabile di non utilizzare l'altalena quando fuori c'e' un temporale.
- *E'consigliabile di proteggere l'altalena dalla pioggia o da forti venti in vostra assenza.

Precauzioni prima del montaggio:

- *Preparare un'area di assemblaggio pulita e asciutta.
- *Verificare che il prodotto non sia danneggiato.
- *Controllare che nessun pezzo manchi.

Manutenzione:

- *Pulire con un panno morbido.
- *Rimuovere regolarmente foglie e / o acqua depositata sul telo.
- *Controllare le giunture regolarmente.

Condizioni per il deposito:

*Il tessuto va riposto completamente asciutto in un luogo asciutto e pulito per evitare i rischi di muffa.

Cautela causa rischio di tagli o pizzicamenti durante l'assemblaggio.

Il produttore declina ogni responsabilita' in caso di lesioni derivanti da montaggio inaccurato o dalle condizioni metereologiche.

IMPORTATO DA:

AOSOM Italy srl
Centro
Direzionale Milanofiori
Strada 1 Palazzo F1
20057 Assago (MI)
P.I.: 08567220960
<https://www.aosom.it>
Prodotto in Cina

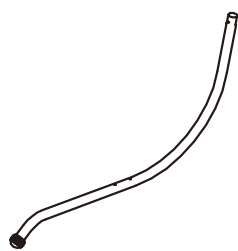

A x 2



B x 2

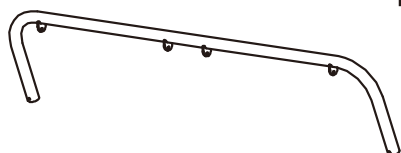

C x 1



F x 1



H x 4

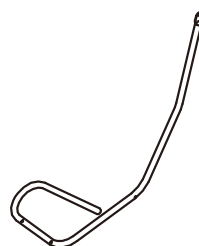

I x 4

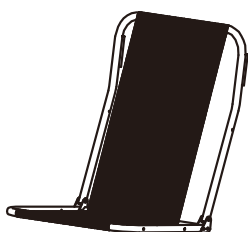

J x 2



K x 2

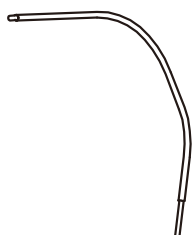

L x 4



M x 2

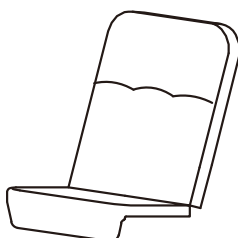

N x 2



X x 1

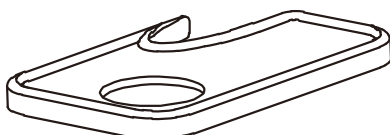

Y x 1

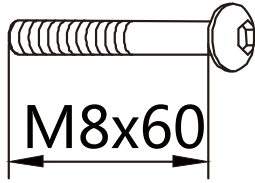

O x 8
+1(spare)

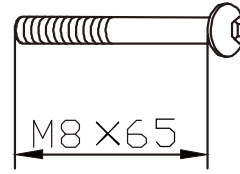

P x 4

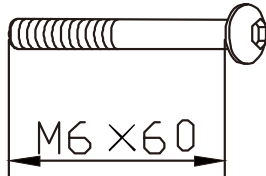

Q x12
+1(spare)

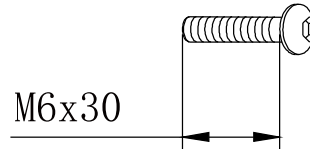

R x 4

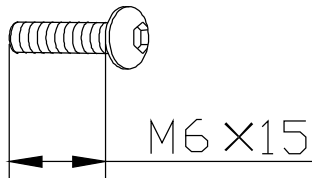

S x 4

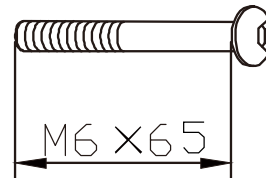

T x 2

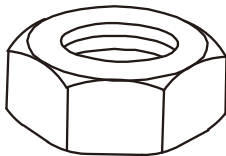

V x14
M6
V x12
M8
+1(spare)



W x14
M6
W x12
M8
+1(spare)

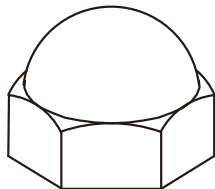

Z x14
M6
Z x12
M8
+1(spare)

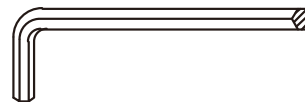

AA x 1
M6
AA x 1
M8
+1(spare)

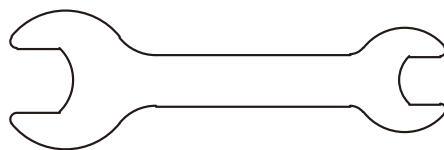

BB x 1

O x 4



M8*60

V x 4



M8

W x 4



M8

Z x 4



M8

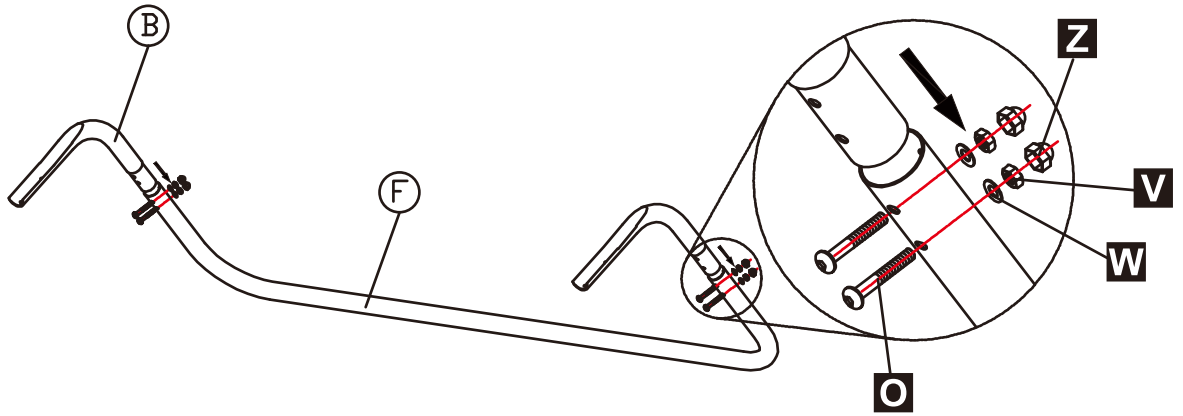

P x 4



M8*65

V x 4



M8

W x 4



M8

Z x 4



M8

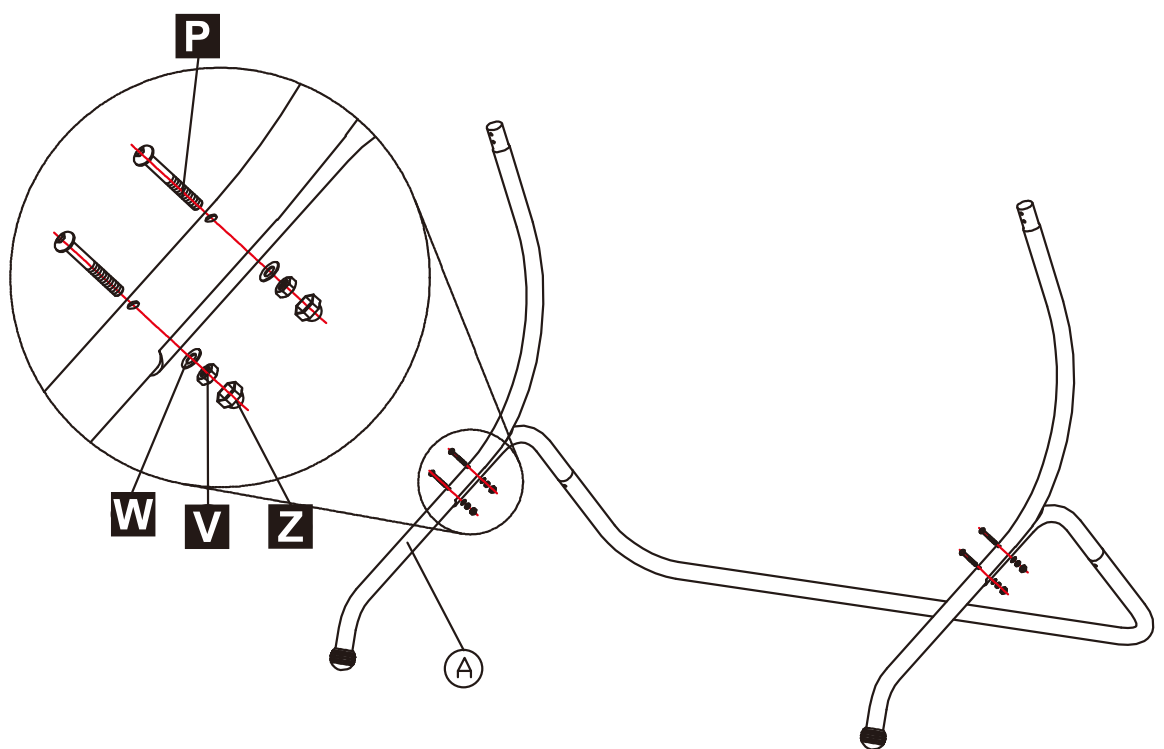

- O** x 4
M8*60
- T** x 2
M6*65
- V** x 4
M8
- V** x 2
M6
- W** x 4
M8
- W** x 2
M6
- Z** x 4
M8
- Z** x 2
M6

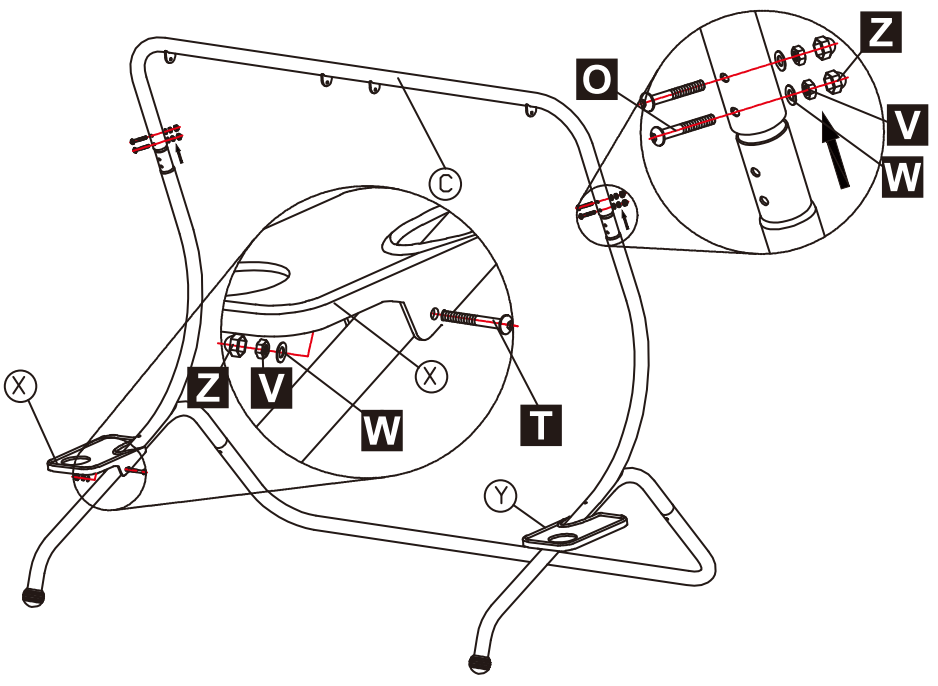

- Q** x 12
M6*60
- V** x 12
M6
- W** x 12
M6
- Z** x 12
M6

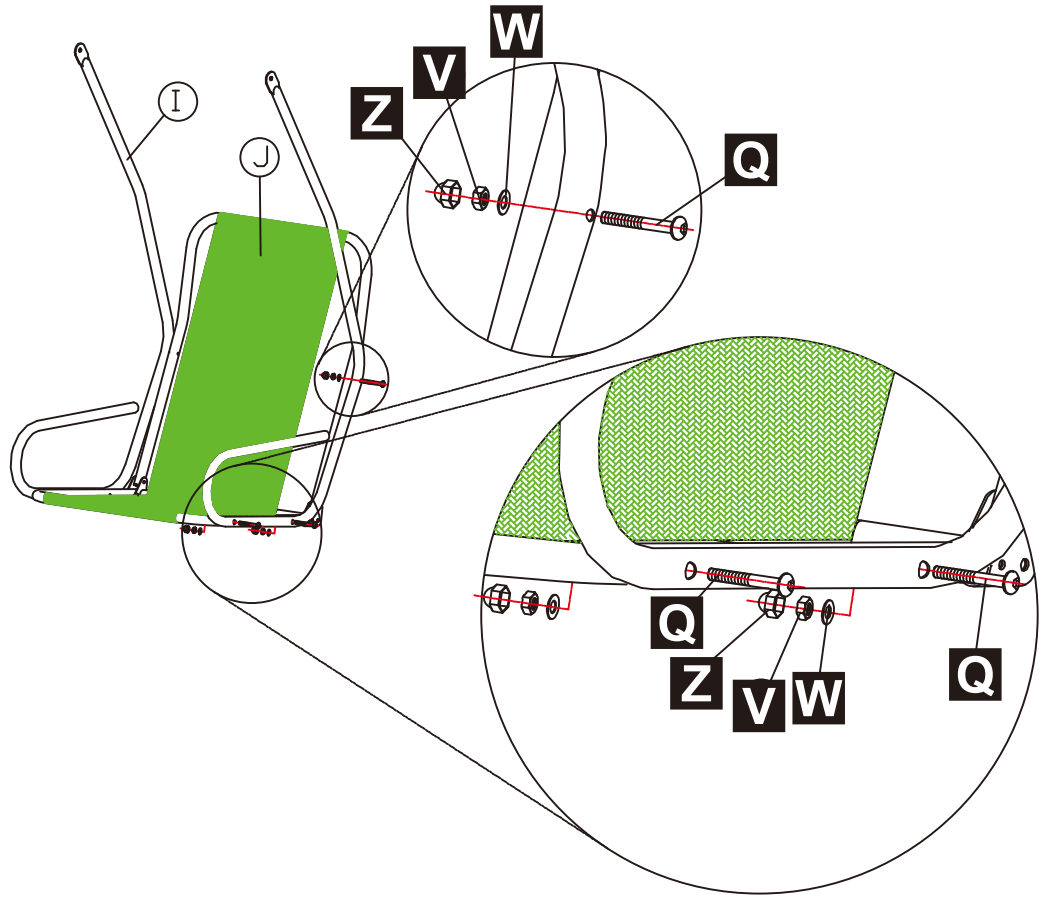

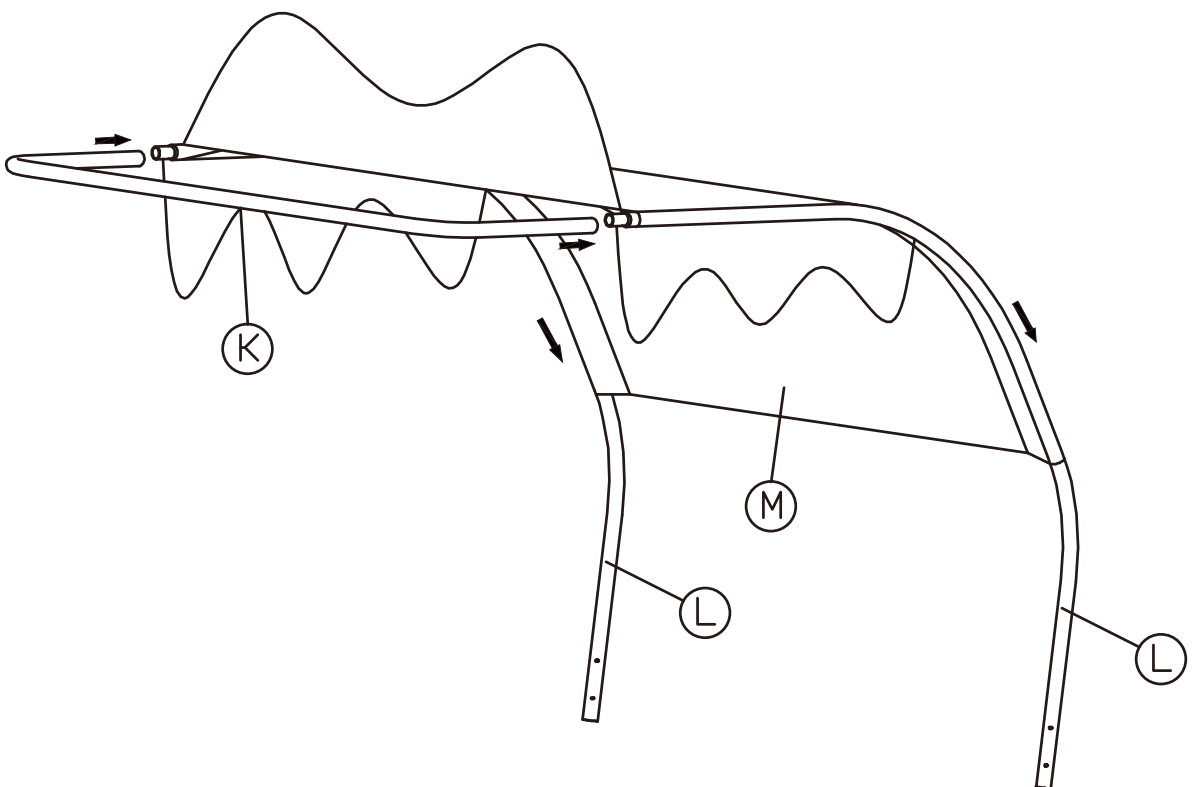
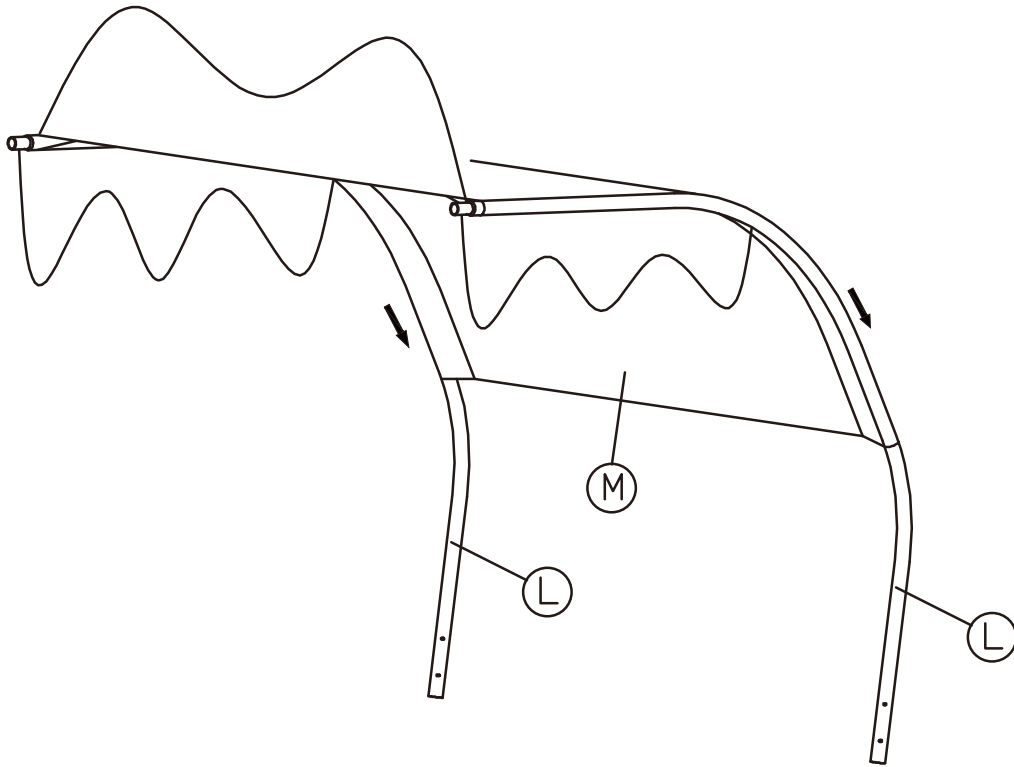

R x 4



M6*30

S x 4



M6*15

