

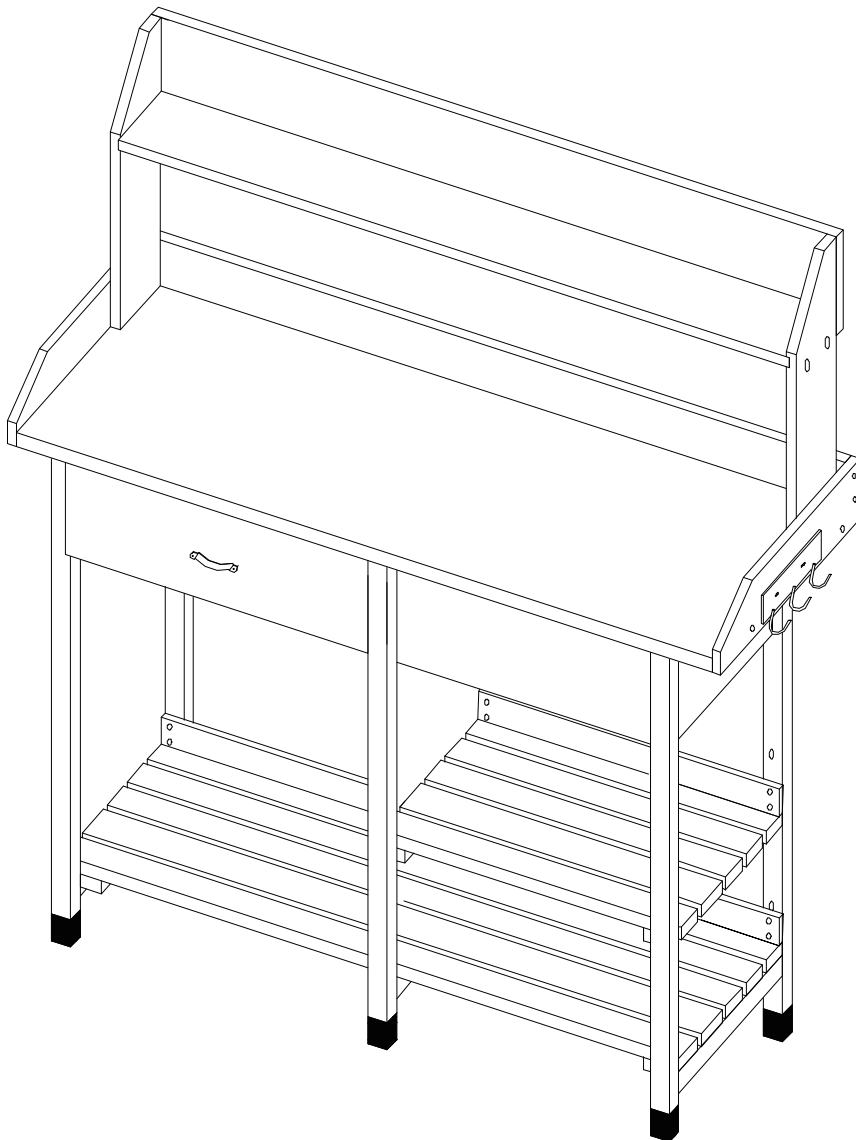

INbme020_GL

845-541



IMPORTANT, RETAIN FOR FUTURE REFERENCE: READ CAREFULLY

ASSEMBLY & INSTRUCTION MANUAL

① x 1

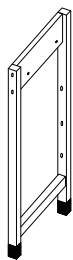

② x 1



③ x 1

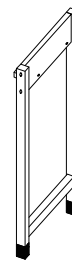

④ x 1

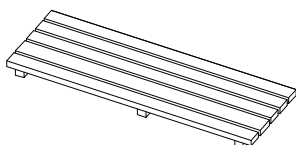

⑤ x 1

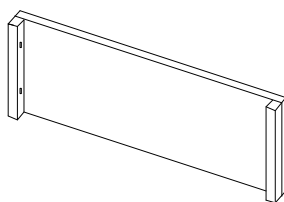

⑥ x 1

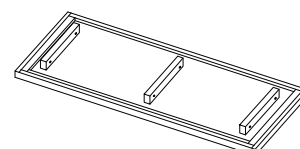

⑦ x 1

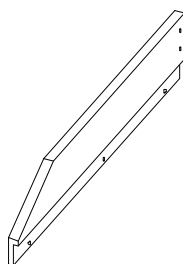

⑧ x 1

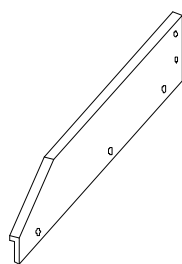

⑨ x 1

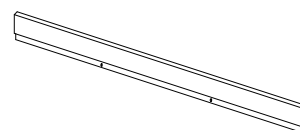

⑩ x 1

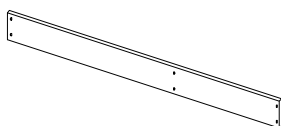

⑪ x 1

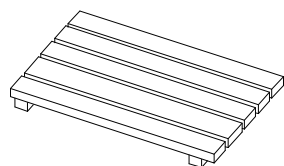

⑫ x 1

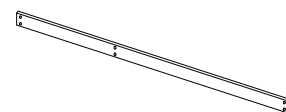

⑬ x 1

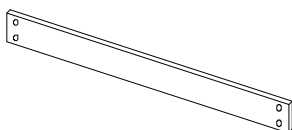

⑭ x 1

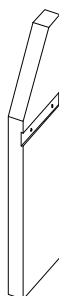

⑮ x 1

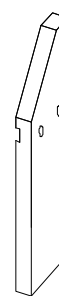

PARTS

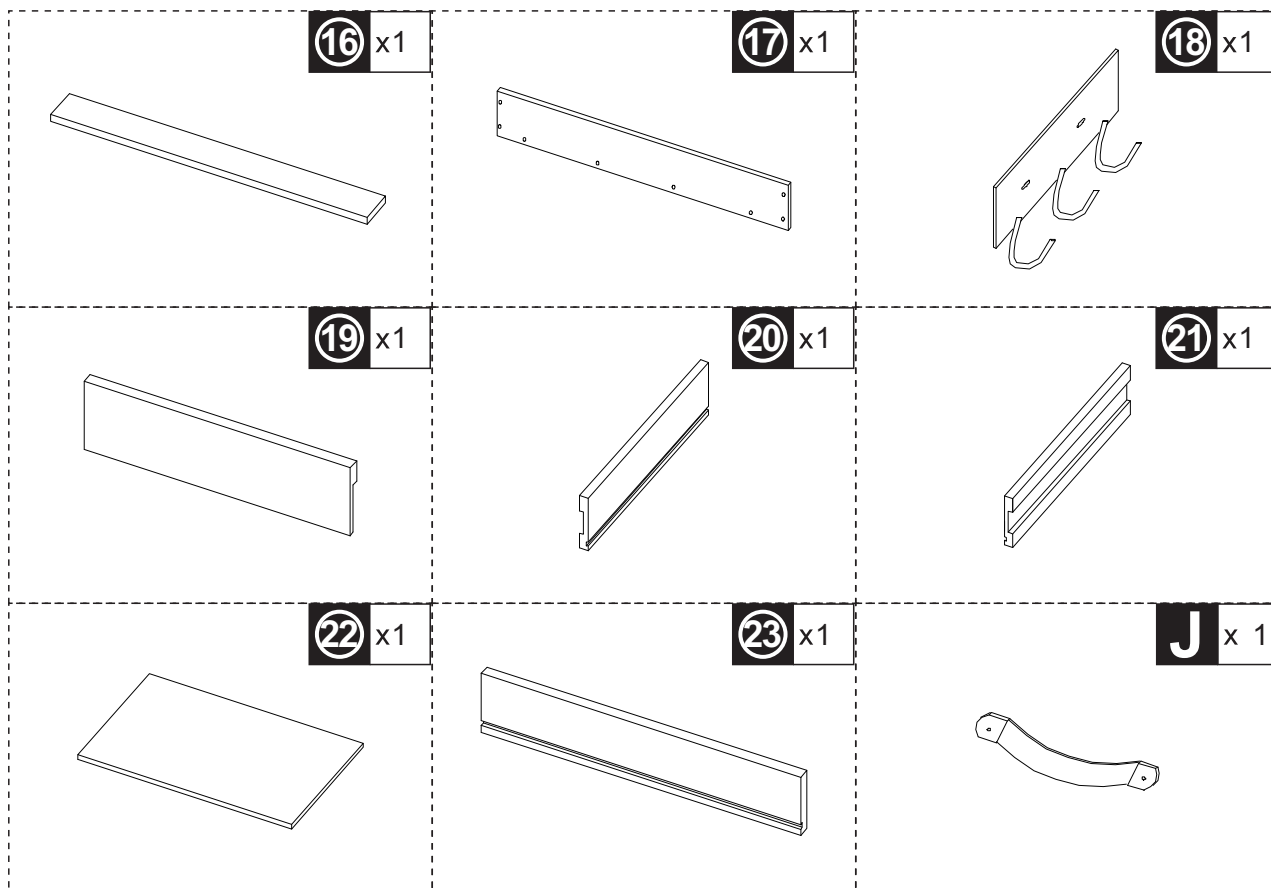

HARDWARE

