

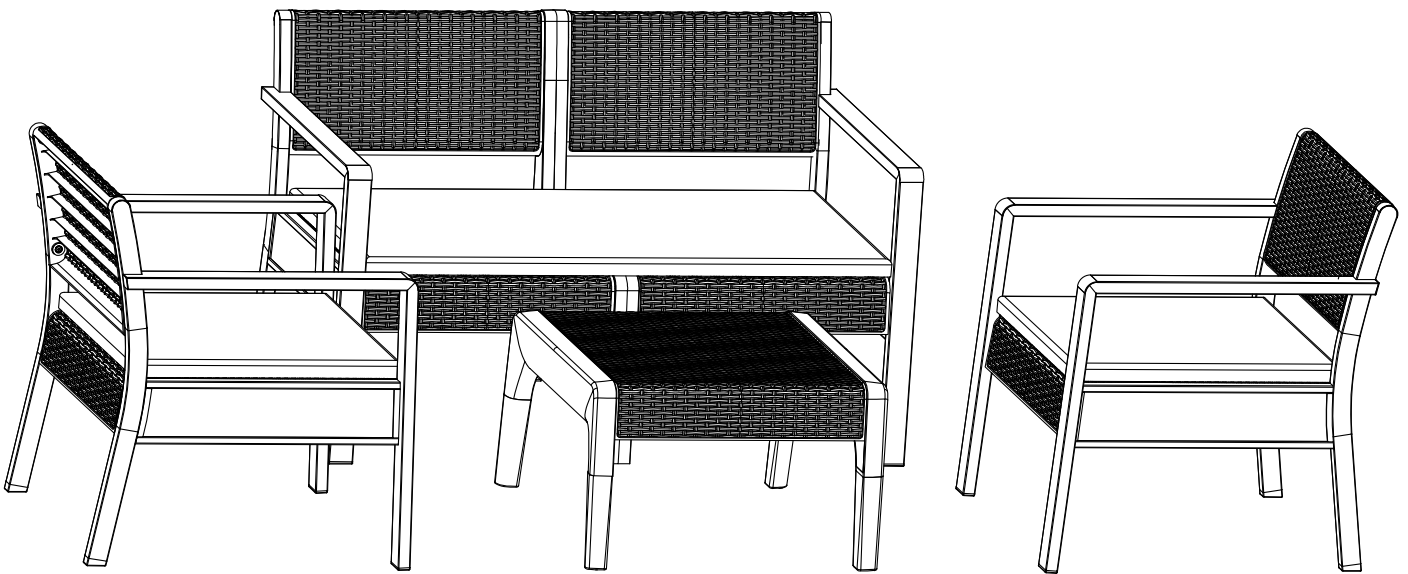

INbta060\_UK\_FR\_ES\_DE\_IT

**84B-722\_84B-722V70**



**IMPORTANT, RETAIN FOR FUTURE REFERENCE: READ CAREFULLY**

**ASSEMBLY & INSTRUCTION MANUAL**

BOX  
1-2

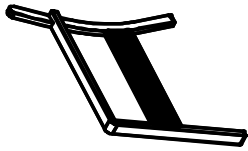

**A** x 2

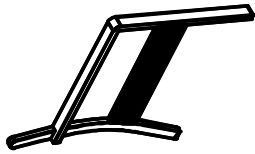

**B** x 2



**C** x 2



**D** x 2

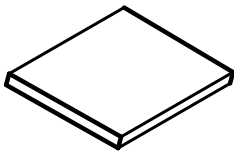

**H** x 2

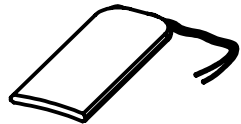

Hardware Kit

BOX  
2-2

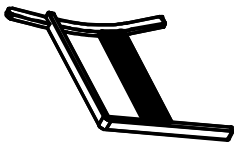

**A** x 1

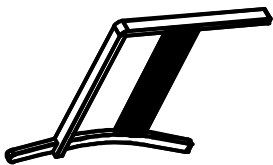

**B** x 1



**C** x 3



**D** x 2

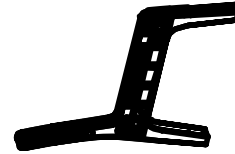

**I** x 1

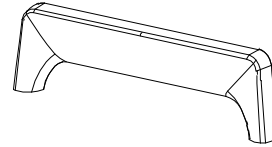

**K** x 2



**M** x 2



**N** x 2

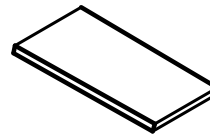

**O** x 1

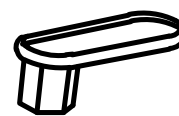

**P** x 2



Hardware Kit

# Garden Chairs

## **IMPORTANT, RETAIN FOR FUTURE REFERENCE: READ CAREFULLY**

### **Only for domestic use**

#### **Use tips:**

- \*Put the chair stably on a flat floor.
- \*Mount the garden chairs in the shelter of the weather.
- \*Stay away from open flames.
- \*Don't hang anything in the structure.
- \*Avoid the overload at the anchors/structure.
- \*It is advised that don't stay on the chairs when there is a storm.
- \*It is recommended to protect in case of strong wind or rain and in your absence.

#### **Precautions before assembly:**

- \*Prepare a clean and dry mounting area.
- \*Verify that the product is not damaged.
- \*Check that none of the pieces are missing.

#### **Maintenance:**

- \*Clean with a soft fabric.
- \*Regularly remove leaves and / or water collected on the canvas.
- \*Check the chair regularly.

#### **Storage conditions:**

\*The fabric should be stored completely dry, in a clean and dry place to avoid the risks of mold.

#### **Caution with the risks of pinching or cuts during assembly.**

**The manufacturer declines all responsibility in case of damages due to a bad installation or due to weather.**

Importer

MH STAR UK LTD  
Unit 27, Perivale Park,  
Horsenden lane South  
Perivale, UB6 7RH  
<https://www.aosom.co.uk>  
Made in China

# Chaises de jardin

## **IMPORTANT - CONSERVEZ CES INFORMATIONS POUR VOTRE CONSULTATION ULTÉRIEURE: LISEZ ATTENTIVEMENT**

**Seulement pour usage domestique**

### **Conseils:**

- \* Placez la chaise de manière stable sur un sol plat.
- \* Installez les chaises de jardin à l'abri des intempéries.
- \* Restez à l'écart des flammes ouvertes.
- \* Ne rien accrocher dans la structure.
- \* Évitez de surcharger les extrémités de la structure
- \* Il est conseillé de ne pas rester sur la chaise en cas d'orage.
- \* Il est recommandé de la protéger en cas de vent fort ou de pluie et en votre absence.

### **Précautions avant l'assemblage:**

- \* Préparez une zone de montage propre et sèche.
- \* Vérifiez que le produit n'est pas endommagé.
- \* Vérifiez qu'aucun des morceaux ne manque.

### **Recommandations d'entretien:**

- \* Veuillez utiliser un chiffon doux pour essuyer la chaise.
- \* Veuillez nettoyer régulièrement l'eau stagnante du fauteuil
- \* Veuillez vérifier régulièrement la chaise pour éviter une structure lâche.

### **Conditions de stockage:**

- \* Veuillez stocker le produit dans un environnement propre et sec pour éviter tout risque de moisissure.

**Veillez faire attention à ne pas être pris ou rayé par le produit lors de l'assemblage**

**Le fabricant n'est pas responsable des dommages causés par une mauvaise installation.**

**Si le fauteuil est équipé d'un dispositif de hauteur réglable avec accumulateur, seul une personne qualifiée peut remplacer ou réparer la partie de hauteur réglable du siège.**

Importateur:

MH FRANCE

2 Rue Maurice Hartmann  
92130 Issy Les Moulineaux

France

<https://www.aosom.fr>

Fabriqué en Chine



# Sillas para Jardín

## **IMPORTANTE-CONSERVE ESTA INFORMACIÓN PARA SU CONSULTA POSTERIOR: LEER DETALLA DAMENTE**

**Solamente para uso doméstico**

### **Consejos de uso:**

- \*Coloque el balancín de forma estable sobre un suelo plano.
- \*Monte las sillas de jardín en el toldo.
- \*Manténgase alejado de llamas abiertas.
- \*No cuelgue nada en la estructura.
- \*Envite la sobrecarga en los anclajes.
- \*Se aconseja no permanecer en el balancín cuando hay tormenta.
- \*Se recomienda resguardar en caso de viento o lluvia fuerte y en su ausencia.

### **Precauciones antes del montaje:**

- \*Prepare una zona de montaje limpia y seca.
- \*Verificar que el producto no este dañado.
- \*Controlar que no falta ninguna de las piezas.

### **Mantenimiento:**

- \*Limpiar con la ayuda de un paño suave.
- \*Eliminar regularmente las hojas y/o agua recogidas sobre la lona.
- \*Inspeccione las sillas regularmente.

### **Condiciones de almacenaje:**

- \*La tela debe ser guardada totalmente seca, en un lugar limpio y seco para evitar los riesgos de moho.

### **Precaución con los riesgos de pinzamientos o cortes durante el montaje.**

**El fabricante declina toda responsabilidad en caso de deterioros debidos a una mala instalación o por causas meteorológicas.**

IMPORTADOR POR:

SPANISH AOSOM, S.L.  
C. roc gros no.15  
08550 Els hostalets de Balenya  
Spain B66295775  
TEL: 931294512  
www.aosom.es  
atencioncliente@aosom.es  
Fabricado en China

# Gartenstühle

## **WICHTIG – BITTE HEBEN SIE DIESE ANLEITUNG FÜR EINE SPÄTERE BEZUGNAHME AUF: SORGFÄLTIG DURCHLESEN**

### **Nur für den häuslichen Gebrauch bestimmt**

#### **Nutzungshinweise:**

- \* Bitte stellen Sie die Schaukel stabil auf eine ebene Fläche.
- \* Stellen Sie die Stühle an einen wettergeschützten Ort.
- \* Von offenen Feuerquellen fernhalten.
- \* Hängen Sie nichts an die Struktur.
- \* Vermeiden Sie eine Überlastung der Anker.
- \* Es wird empfohlen, die Schaukel bei schlechten Wetterbedingungen nicht zu benutzen.
- \* Es wird empfohlen, die Schaukel während Ihrer Abwesenheit vor starkem Regen oder starkem Wind zu schützen.

#### **Vorsichtsmaßnahmen vor der Montage:**

- \* Bitte bereiten Sie einen sauberen und trockenen Montagebereich vor.
- \* Stellen Sie sicher, dass das Produkt nicht beschädigt ist.
- \* Vergewissern Sie sich, dass keines der Zubehöerteile fehlt.

#### **Instandhaltung:**

- \* Bitte reinigen Sie die Schaukel nur mit einem weichen Tuch.
- \* Bitte entfernen Sie regelmäßig alle Blätter und / oder Wasser, die sich auf dem Stoff angesammelt haben.
- \* Überprüfen Sie die Gartenstühle regelmässig.

#### **Lagerung:**

- \* Der Stoff sollte an einem völlig trockenen und sauberen Ort aufbewahrt werden, um Schimmel zu vermeiden.

#### **Vorsicht vor Quetsch- und Schnittgefahr bei der Montage.**

**Der Hersteller lehnt jede Haftung für Schäden ab, die durch unsachgemäße Installation oder Witterungseinflüsse verursacht wurden.**

Importeur :

MH Handel GmbH  
Wendenstraße 309  
D-20537 Hamburg  
Germany  
<https://www.aosom.de>  
Hergestellt in China

# Sedie da giardino

**IMPORTANTE-CONSERVARE QUESTE INFORMAZIONI  
PER CONSULTARLE IN SEGUITO: LEGGERE  
ATTENTAMENTE**

**Solo per uso domestico**

**Consigli per l'uso:**

- \*Posizionare l'altalena saldamente su una superficie piana.
- \*Montare le sedie da giardino al riparo dalle intemperie del tempo.
- \*Tenere lontano dal fuoco.
- \*Non appendere alcun oggetto alla struttura.
- \*Evitare di sovraccaricare le giunture.
- \*E' consigliabile di non utilizzare l'altalena quando fuori c'e' un temporale.
- \*E' consigliabile di proteggere l'altalena dalla pioggia o da forti venti in vostra assenza.

**Precauzioni prima del montaggio:**

- \*Preparare un'area di assemblaggio pulita e asciutta.
- \*Verificare che il prodotto non sia danneggiato.
- \*Controllare che nessun pezzo manchi.

**Manutenzione:**

- \*Pulire con un panno morbido.
- \*Rimuovere regolarmente foglie e / o acqua depositata sul telo.
- \*Controllare le sedie regolarmente.

**Condizioni per il deposito:**

\*Il tessuto va riposto completamente asciutto in un luogo asciutto e pulito per evitare i rischi di muffa.

**Cautela causa rischio di tagli o pizzicamenti durante l'assemblaggio.**

**Il produttore declina ogni responsabilita' in caso di lesioni derivanti da montaggio inaccurato o dalle condizioni metereologiche.**

IMPORTATO DA:

AOSOM Italy srl  
Centro  
Direzionale Milanofiori  
Strada 1 Palazzo F1  
20057 Assago (MI)  
P.I.: 08567220960  
<https://www.aosom.it>  
Prodotto in Cina

**PARTS**

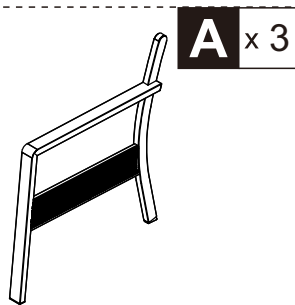

**A** x 3

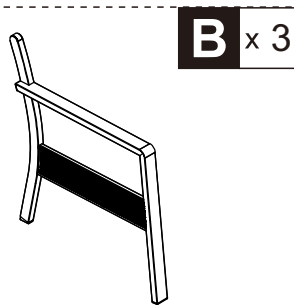

**B** x 3

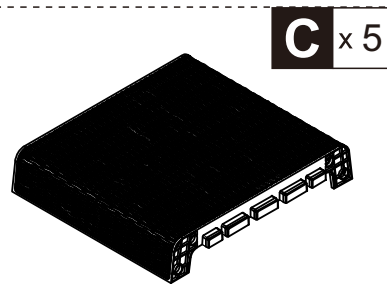

**C** x 5

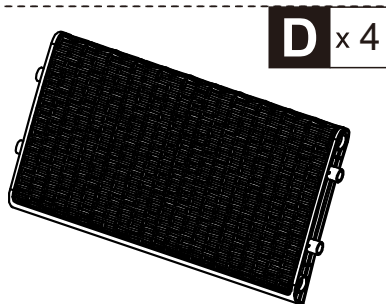

**D** x 4

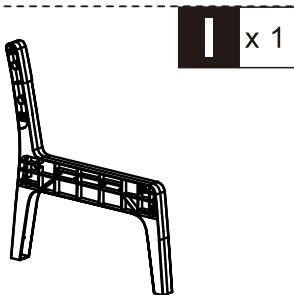

**I** x 1

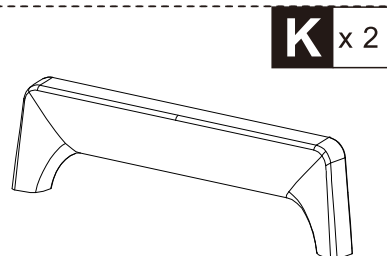

**K** x 2

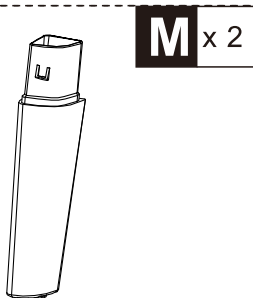

**M** x 2

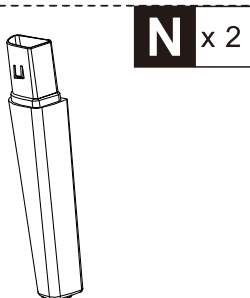

**N** x 2

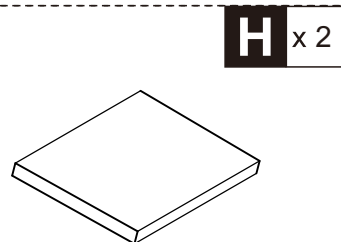

**H** x 2

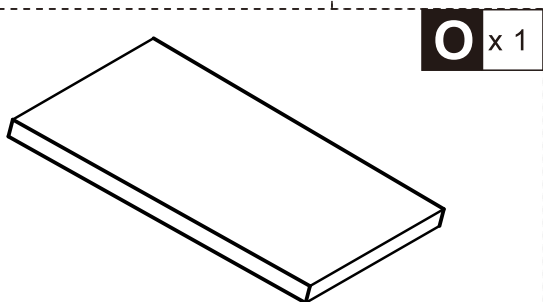

**O** x 1

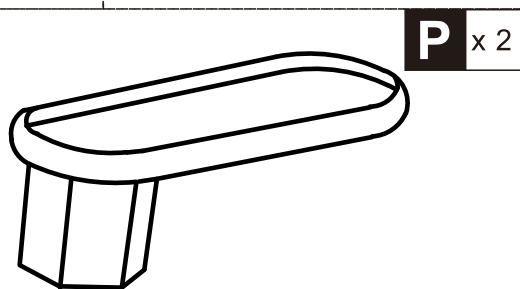

**P** x 2

**HARDWARE**

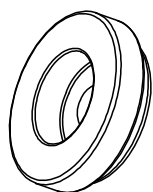

**E** x36  
D6  
+1(spare)

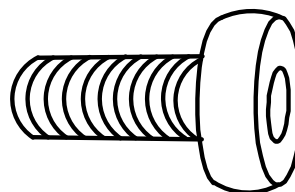

**F** x36  
M6\*20  
+1(spare)

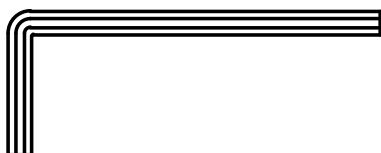

**G** x 2  
S4

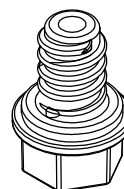

**J** x20  
+1(spare)

01

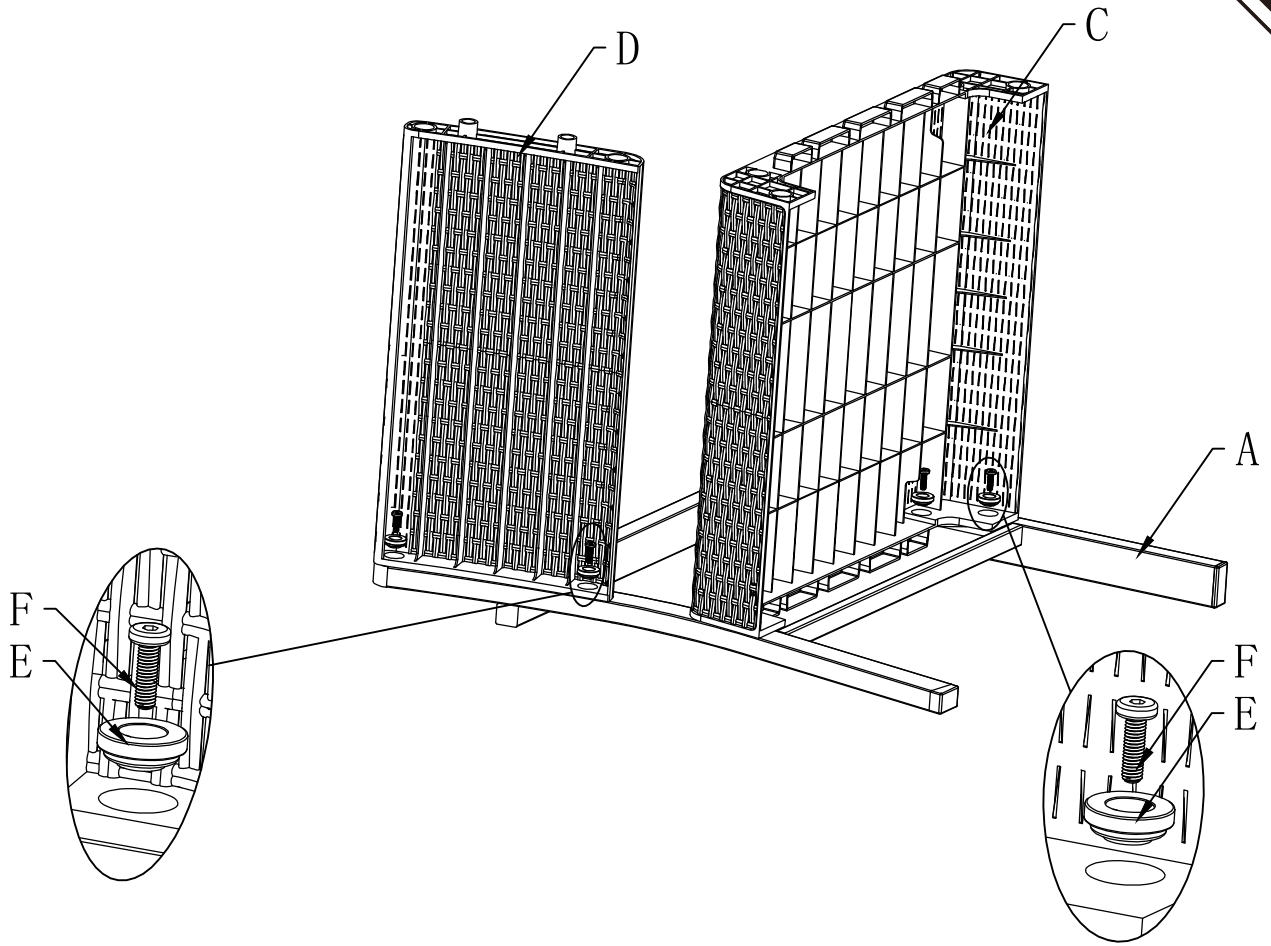

02

