

PawHut®

INbya002_GL

845-323V01

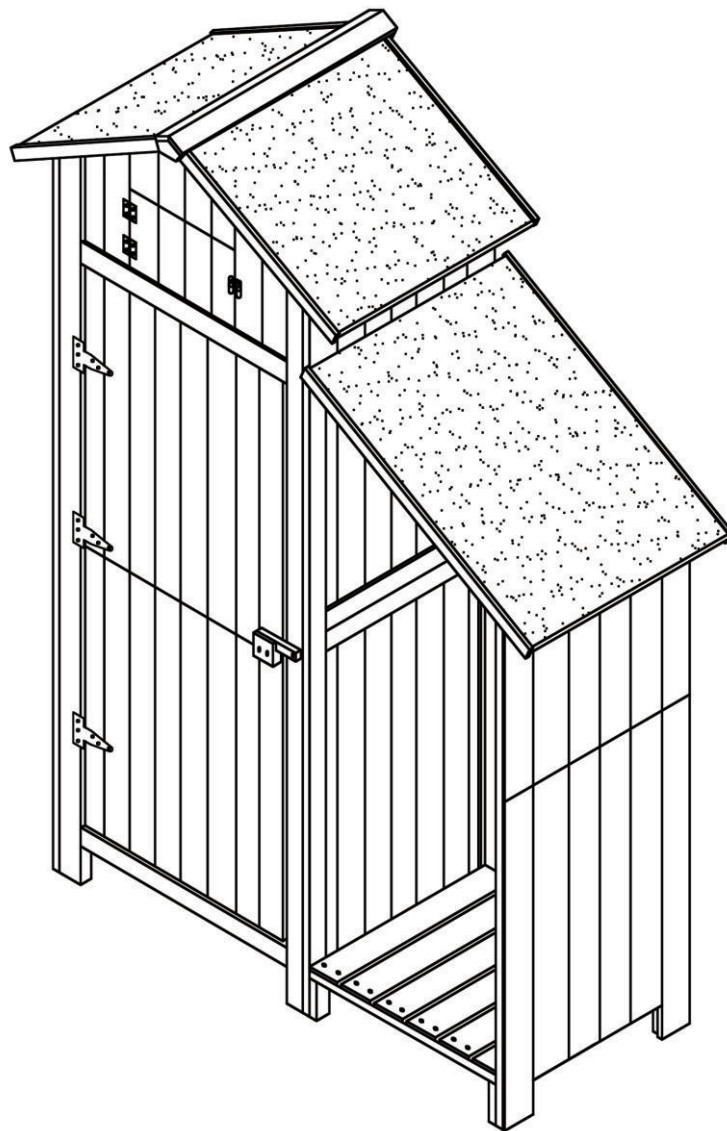

IMPORTANT, RETAIN FOR FUTURE REFERENCE: READ CAREFULLY

ASSEMBLY & INSTRUCTION MANUAL

EN

1. This product must be assembled by an adult.
2. Do not over torque screws and bolts.
3. Do not install in flammable place in case of fire.
4. Use on a flat ground.

FR

1. Ce produit doit être assemblé par un adulte.
2. Ne serrez pas trop les vis et boulons.
3. N'installez pas le produit à l'endroit inflammable en cas d'incendie.
4. Veuillez l'utiliser sur un terrain plat.

ES

1. Esta jaula para mascota debe ser ensamblado por un adulto.
2. No apriete los tornillos y pernos demasiado.
3. Para evitar incendios, no instale la jaula para mascota en un lugar inflamable.
4. Utilice la jaula para mascota sobre un terreno plano.











DE

1. Dieses Produkt sollte von einem Erwachsenen zusammengestellt werden.
2. Ziehen Sie die Schrauben und Bolzen nicht zu fest an.
3. Installieren Sie im Brandfall nicht an brennbaren Orten.
4. Bitte verwenden Sie es auf einem ebenen Boden.

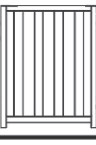
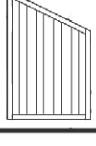

IT

1. Questo prodotto va assemblato da un adulto.
2. Non stringere eccessivamente viti e bulloni.
3. Non installare in un luogo esposto a potenziali incendi.
4. Si prega di usare su una superficie piana.

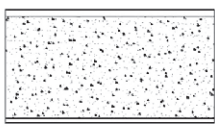

BOX-1/2

NO.	PARTS	QTY
A		1
B		1
G		1
H		1
I		1
J		1
K		2
L		3
M		1
N		1
Q		1

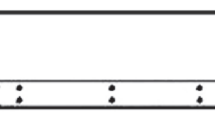



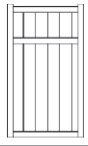
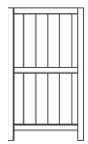
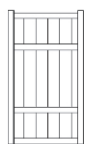
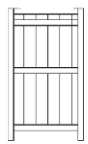
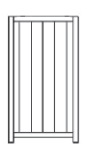



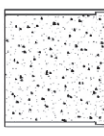

BOX-1/2

NO.	PARTS	QTY
S		1
T		1
U		1

BOX-2/2

NO.	PARTS	QTY
C		1
D		1
E		1
F		1
O		1
P		1

BOX-2/2

NO.	PARTS	QTY
R		2
①	 M3.0*20	12
②	 M3.5*50	12
③	 M3.5*40	22
④	 M3.5*30	12
⑤	 M3.5*25	11
⑥		3
⑦	 M3.0*18	18
⑧		42
⑨		1
⑩		2

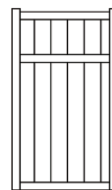
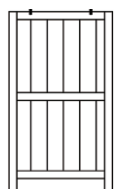
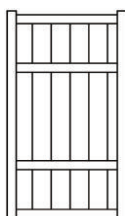
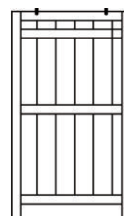
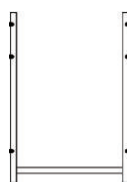
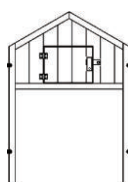
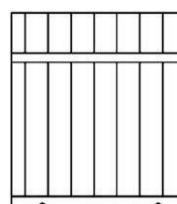
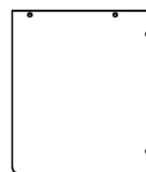
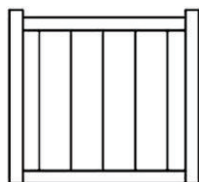
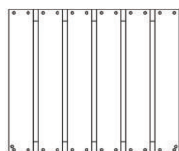
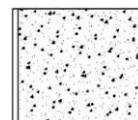
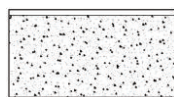
**A** x 1**B** x 1**C** x 1**D** x 1**E** x 1**F** x 1**G** x 1**H** x 1**I** x 1**J** x 2**K** x 2**L** x 3**M** x 1**N** x 1**O** x 1**P** x 1**Q** x 1**R** x 2**S** x 1**T** x 1**U** x 1

① x12



M3*20

② x12



M3.5*50

③ x22



M3.5*40

④ x12



M3.5*30

⑤ x11



M3.5*25

⑥ x 3



⑦ x18



M3*18

⑧ x42



⑨ x 1



⑩ x 2

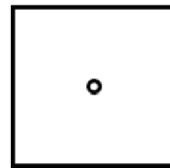

8 x42

01

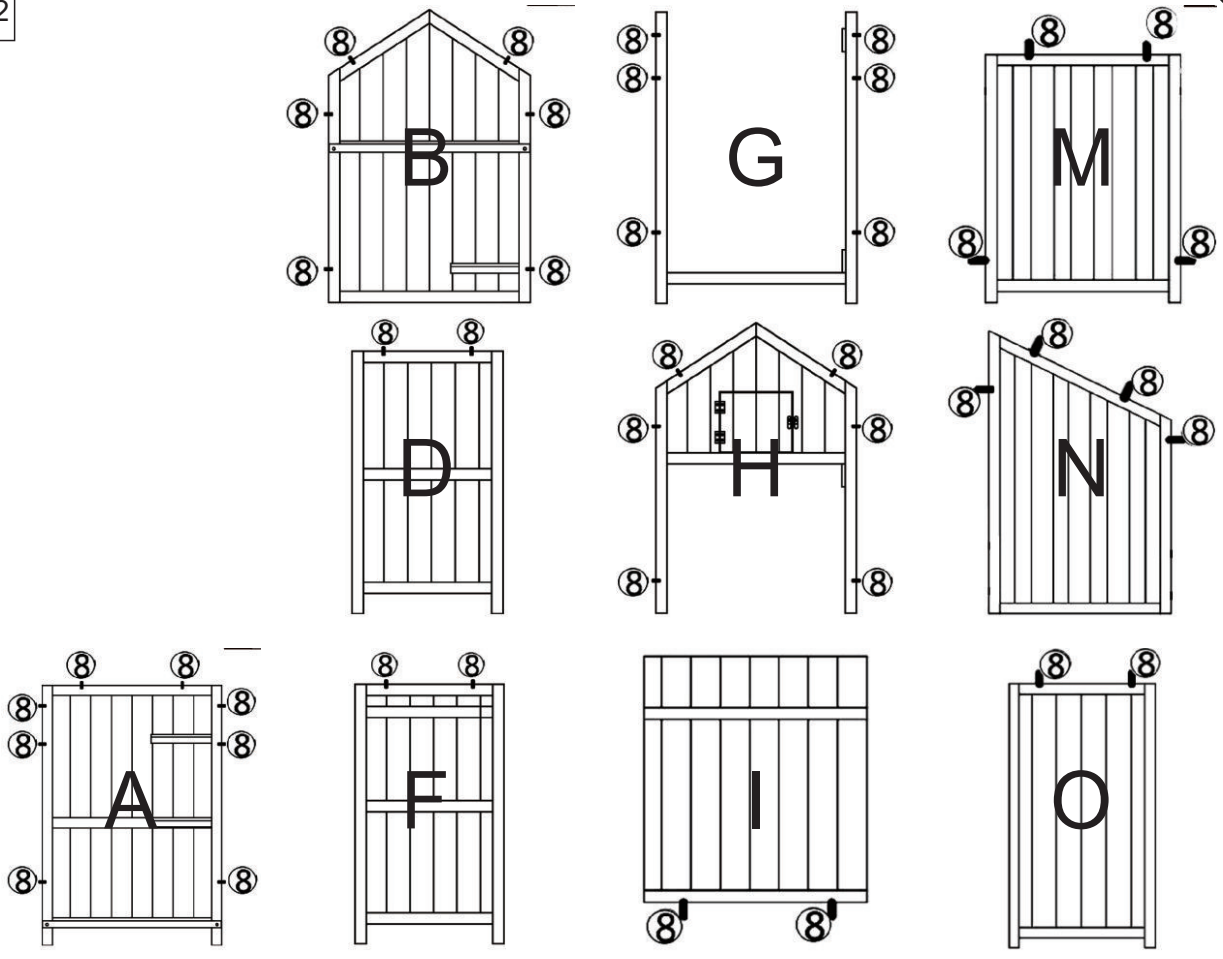

A x 1

D x 1

F x 1

3 x 4
M3.5*40

02

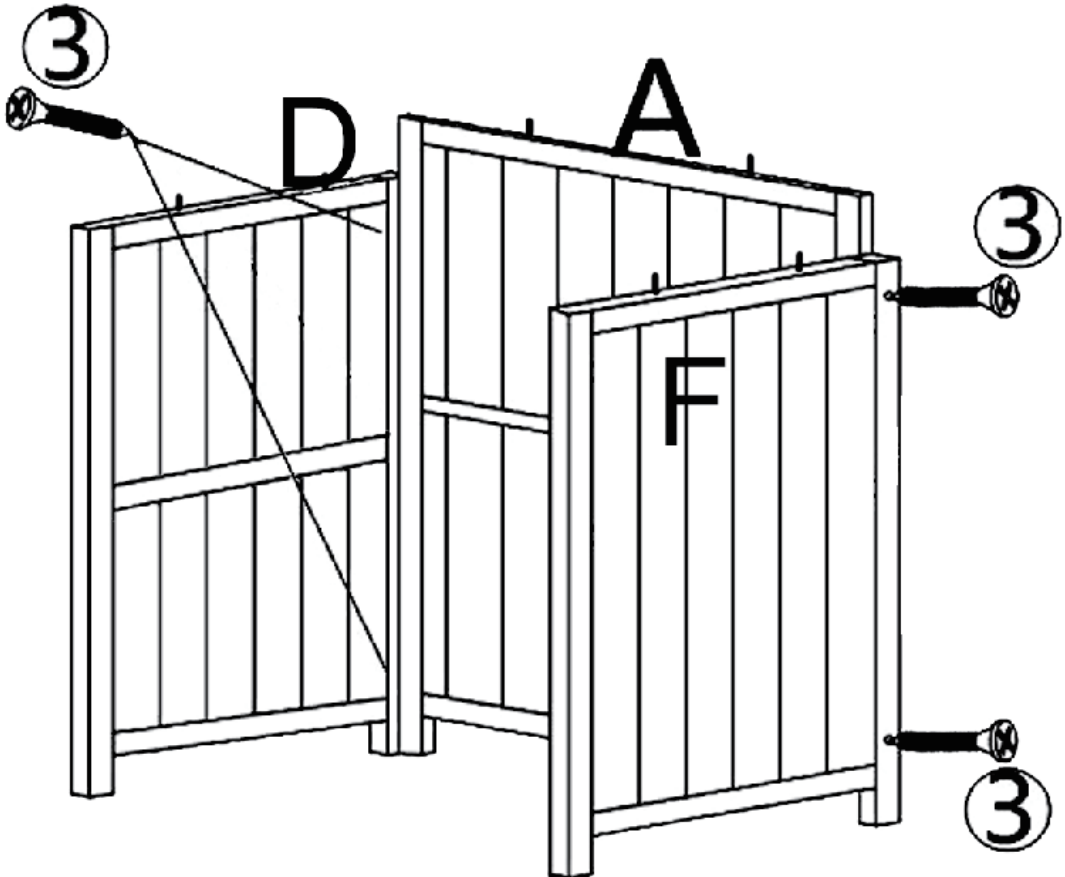

B x 1

C x 1

E x 1

3 x 6
M3.5*40

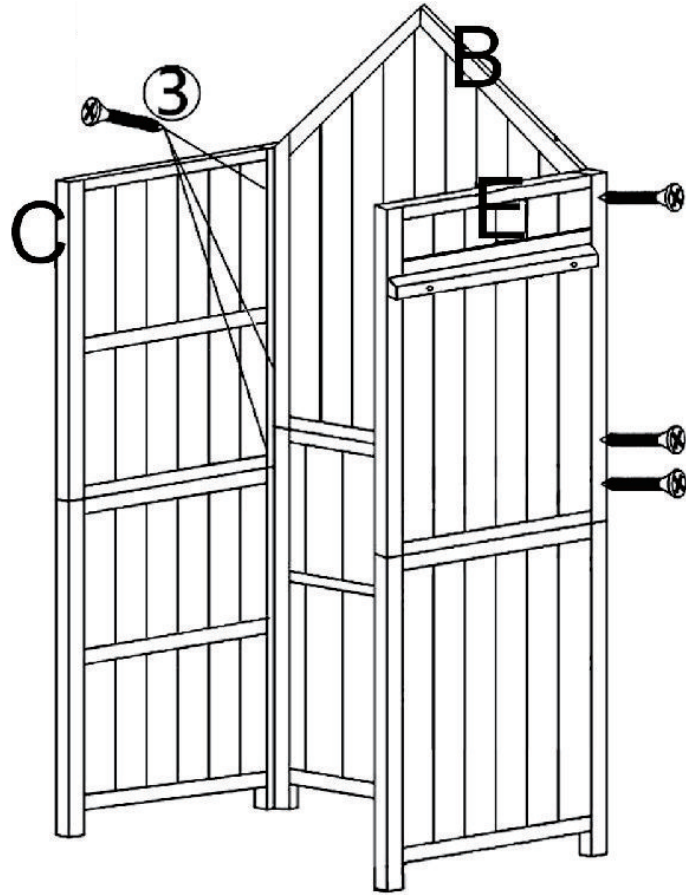

G x 1

H x 1

3 x 10
M3.5*40

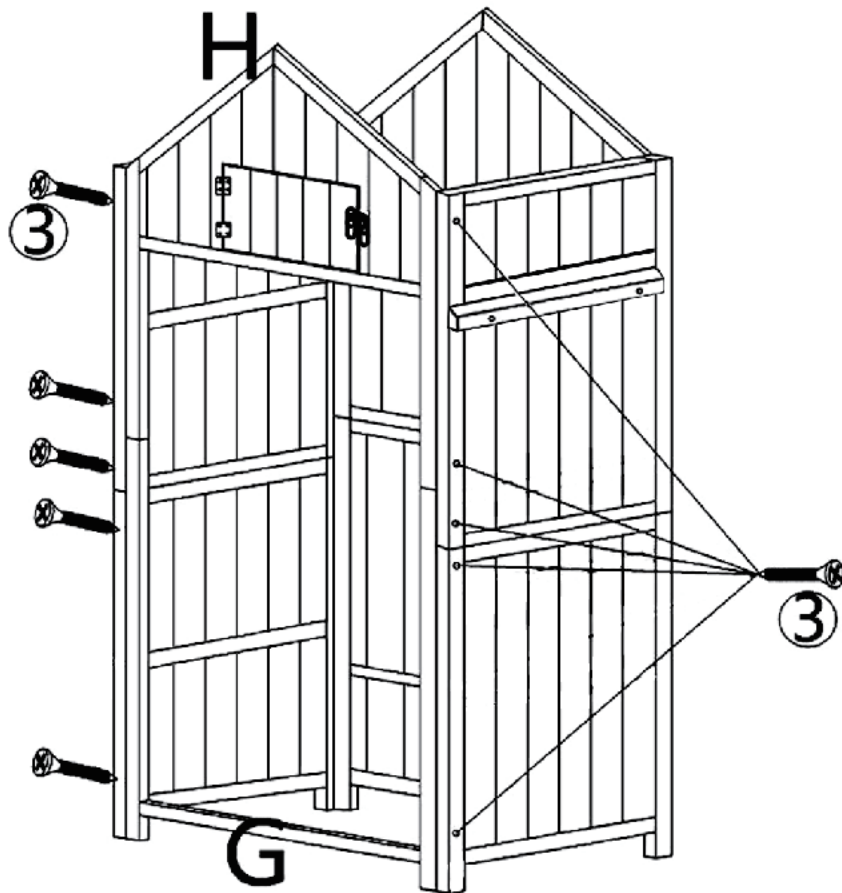

I x 1

J x 1

U x 1

5 x 6
M3.5*25

6 x 3

7 x 18
M3*18

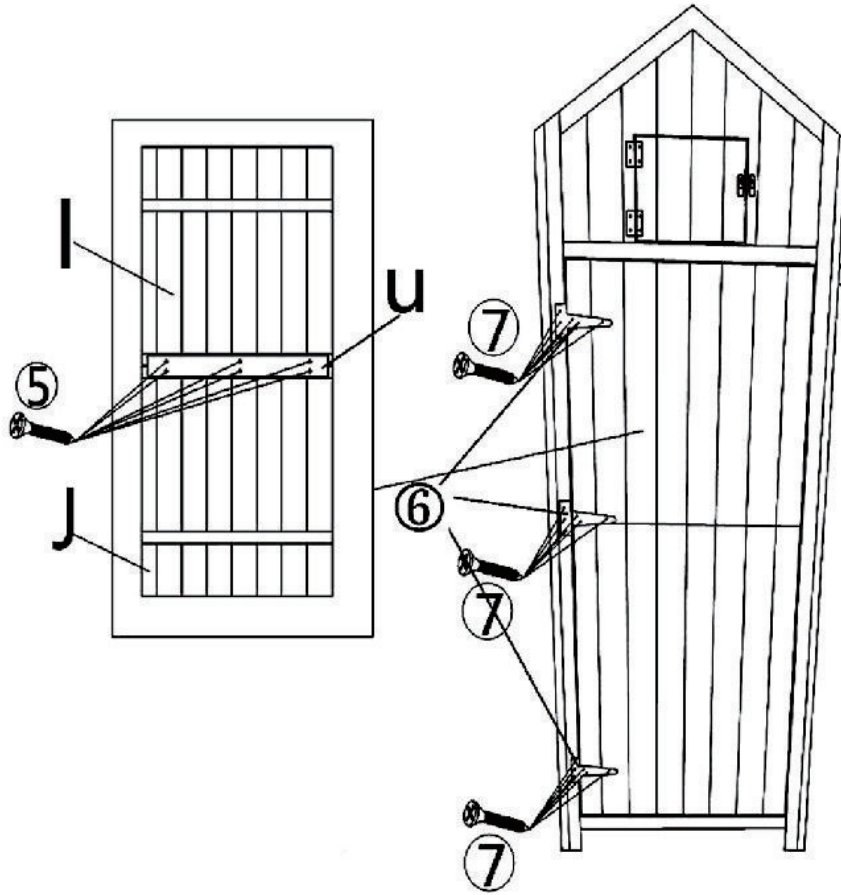

L x 3

1 x 12
M3*20

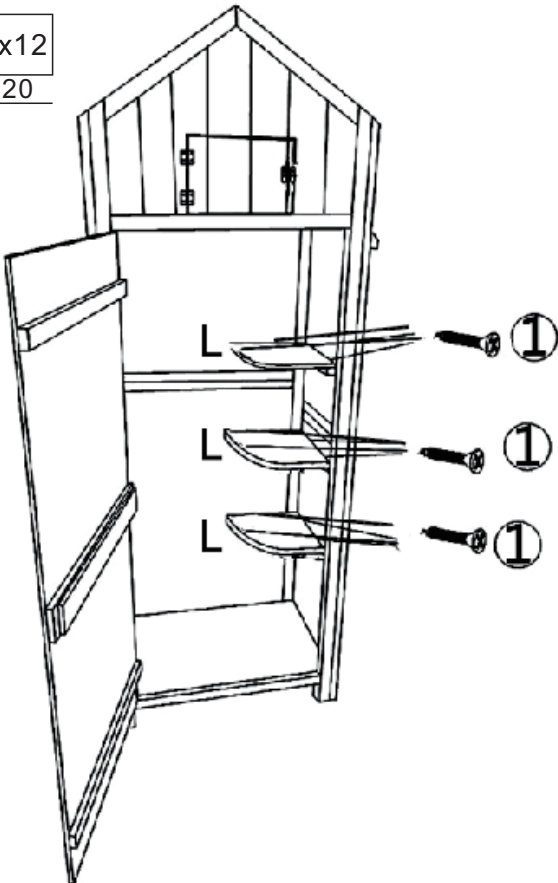

K x 2

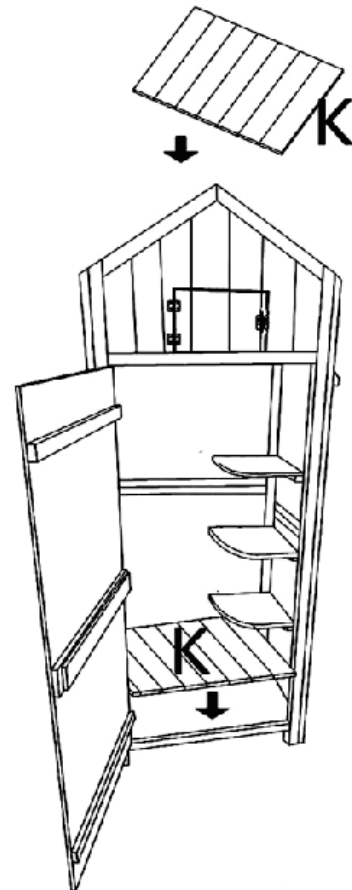

M x 1

N x 1

O x 1

P x 1

② x 4

M3.5*50

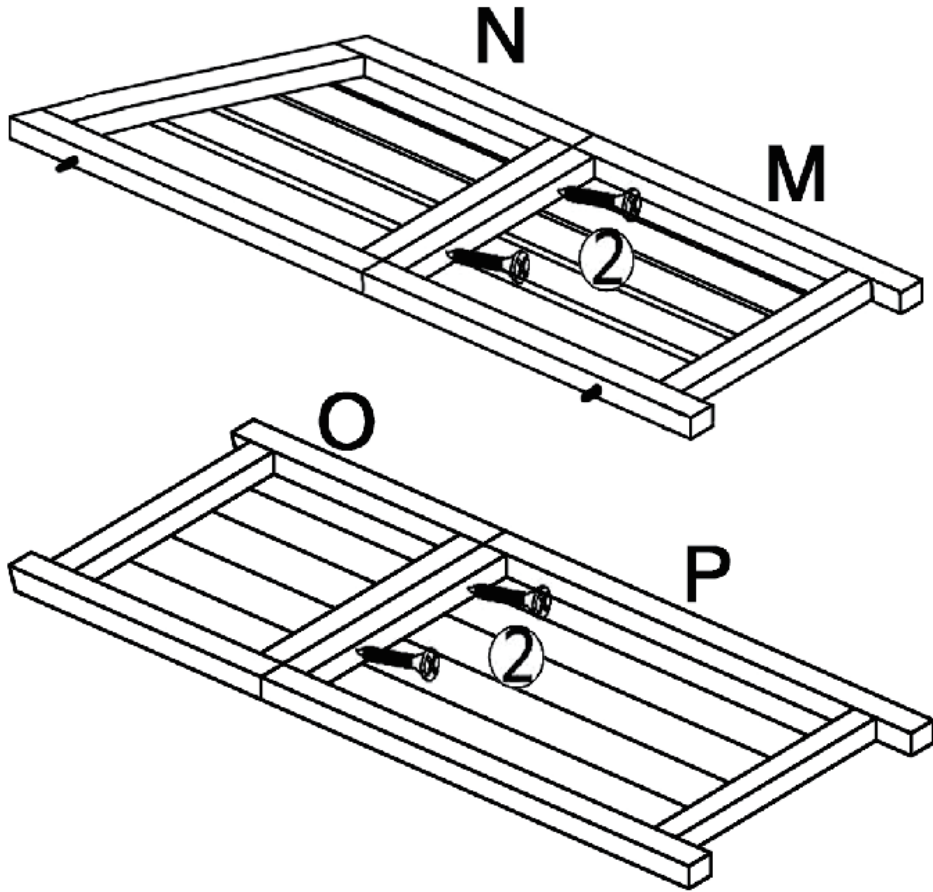

② x 4

M3.5*50

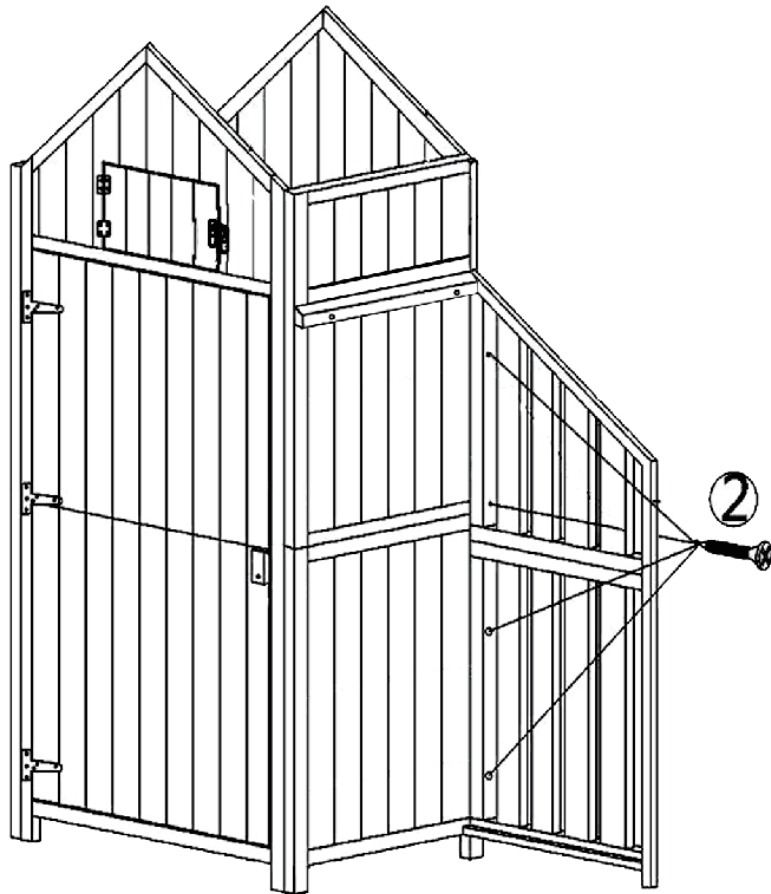

② x 4

M3.5*50

④ x 4

M3.5*30

⑩ x 2

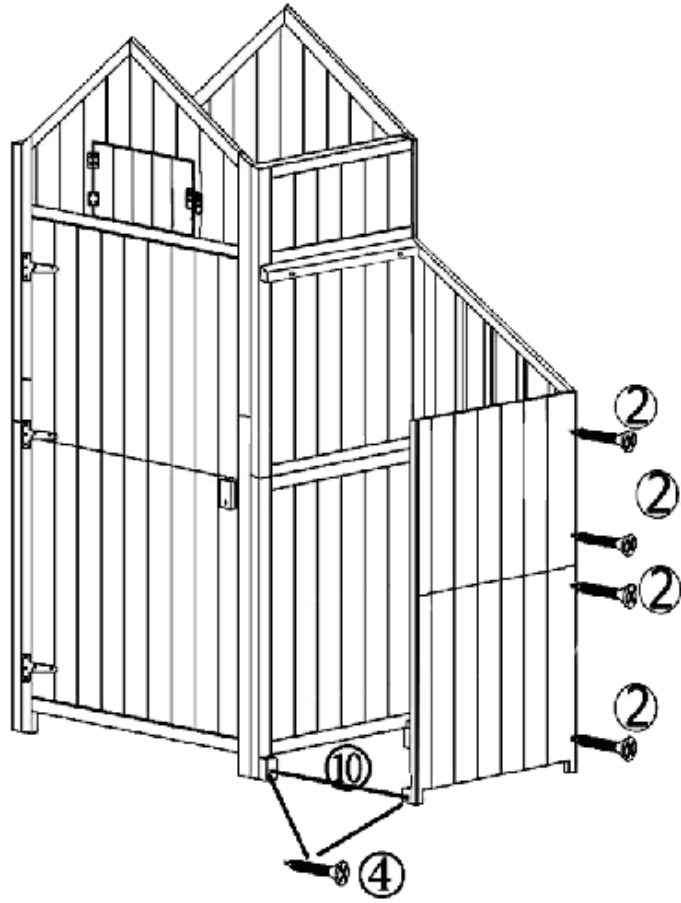

Q x 1

③ x 2

M3.5*40

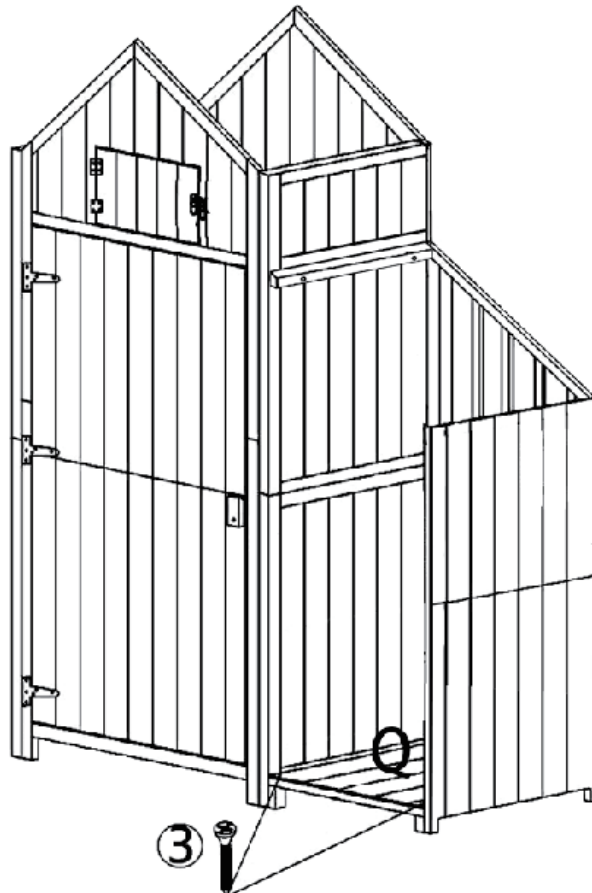

R x 2

S x 1

4 x 8

M3.5*30

5 x 1

M3.5*25

9 x 1

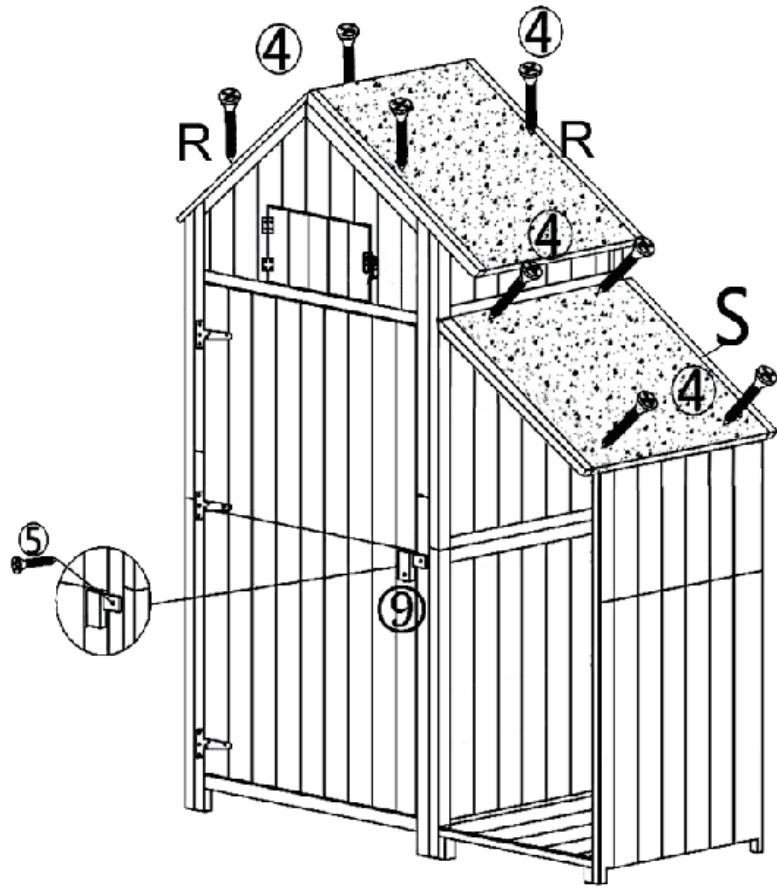

T x 1

5 x 4

M3.5*25

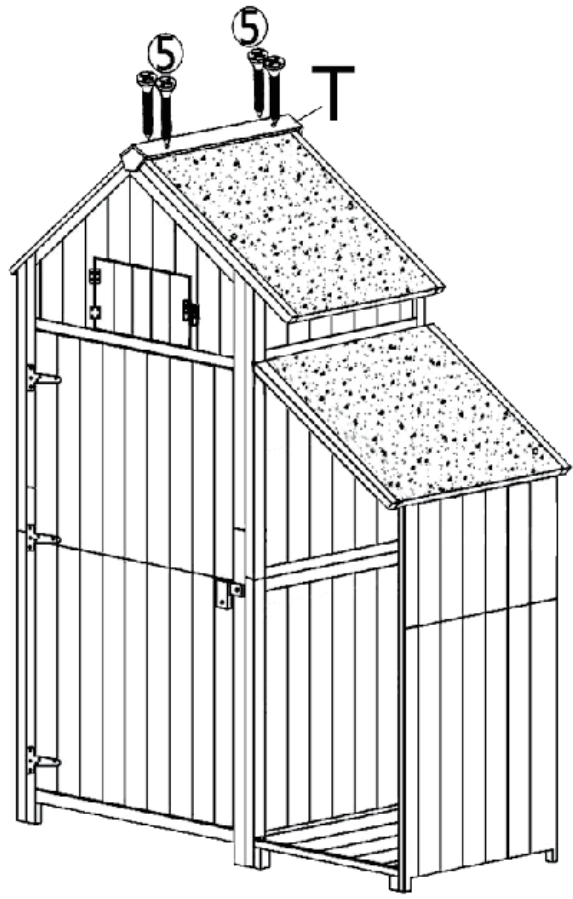

US



001-877-644-9366
customerservice@aosom.com

CA



001-855-537-6088
customerservice@aosom.ca

UK



0044-800-240-4004
enquiries@mhstar.co.uk

DE



0049-(0)40-88307530
service@aosom.de

FR



0033-1-84166106
contact@aosom.fr

ES



0034-931294512
atencioncliente@aosom.es

IT



0039-0249471447
clienti@aosom.it