



INbzb015_GL

842-218



IMPORTANT, RETAIN FOR FUTURE REFERENCE: READ CAREFULLY



ASSEMBLY INSTRUCTION



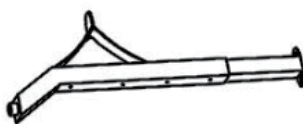

PACKING DETAILS: TOTAL 2 BOXES

BOX-1/2

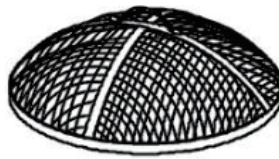
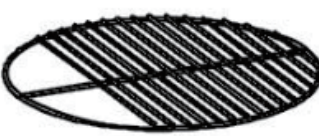
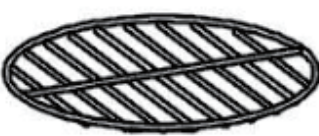
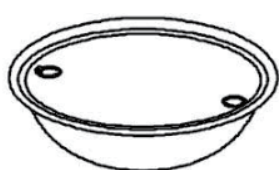
NO.	PARTS	QTY
A		1

BOX-2/2

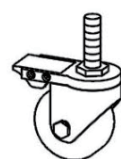
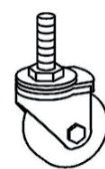
NO.	PARTS	QTY
B		4
C		1
D		1
E		1
F		1
G		1

NO.	PARTS	QTY
I		1
J		12
K		2
L		2
M		1

PARTS

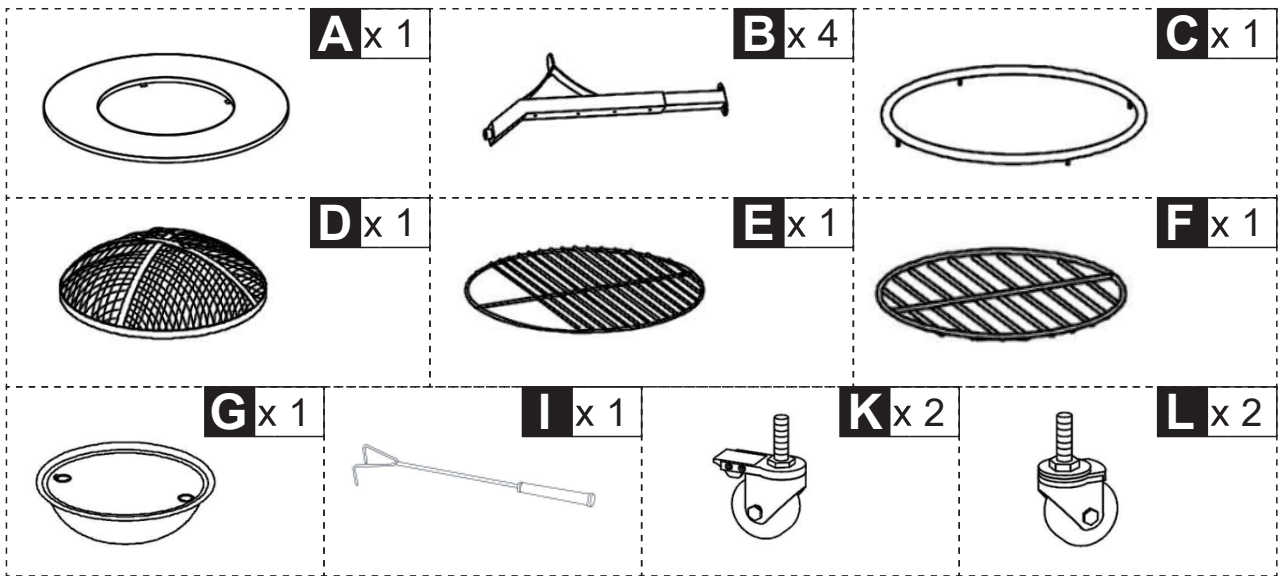

HARDWARE

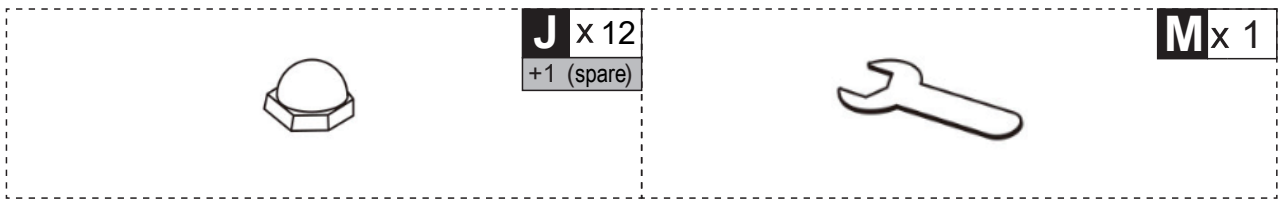

01

