



INcji008V01\_UK\_DE

**820-311V00**

# Rail Radiator

EN

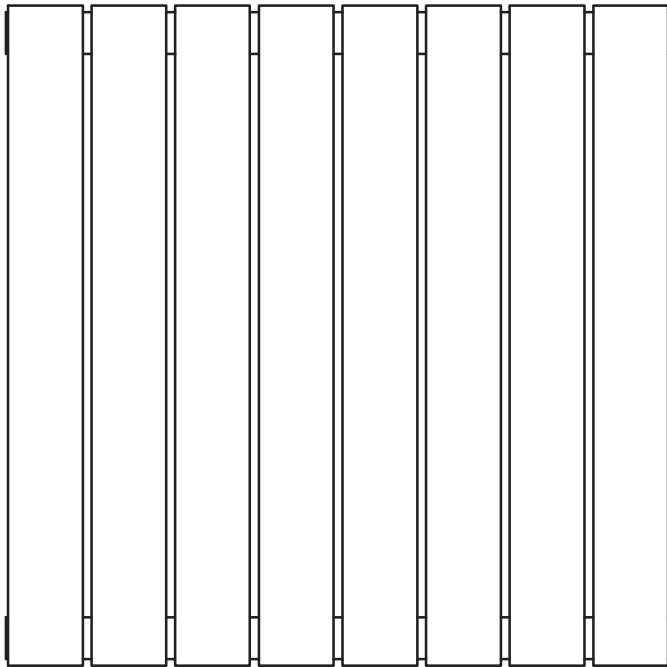

UK  
CA CE

IMPORTANT, RETAIN FOR FUTURE REFERENCE: READ CAREFULLY

**UESR'S MANUAL**

Unit:mm

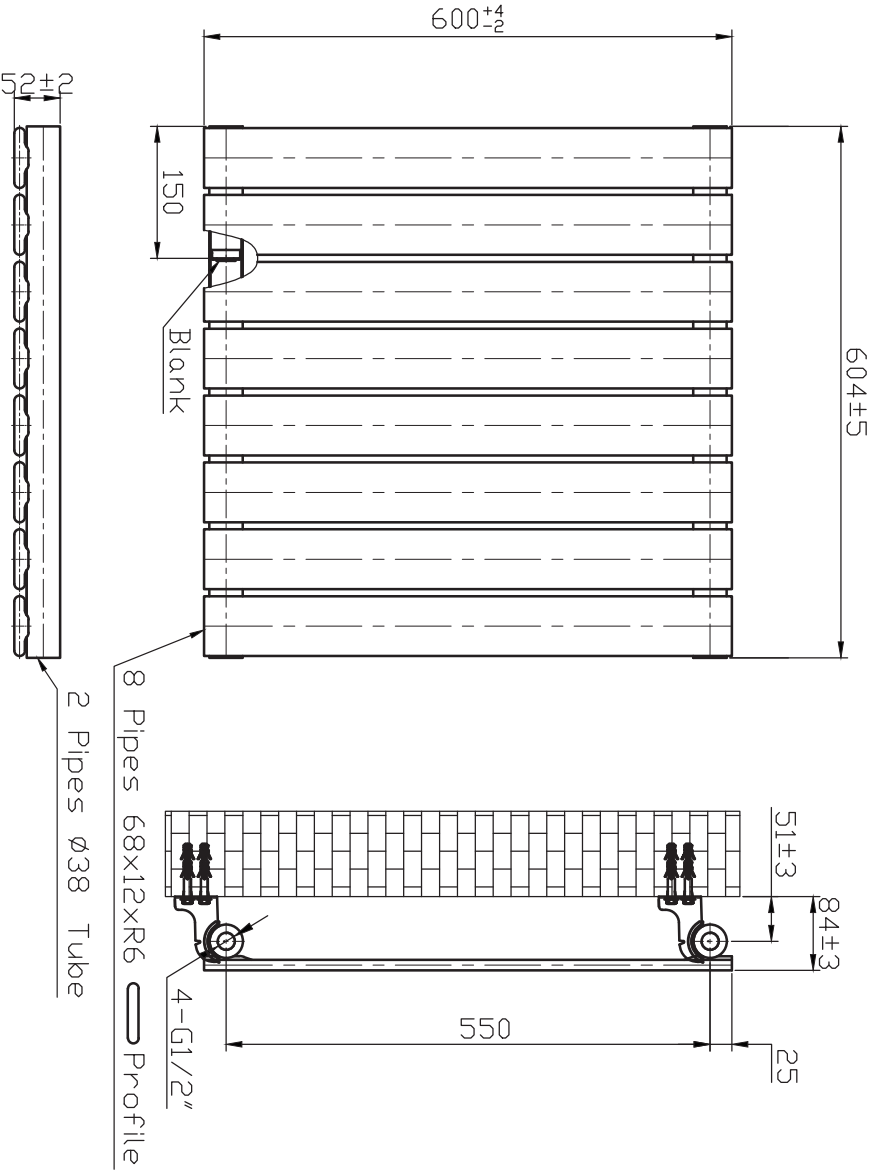







## Dear customer,

Thank you for purchasing this product. For you to protect and install this appliance properly, please read the manual thoroughly before using. Keep this manual safe for future reference.

## 1. Product features

Pictures in this manual is for reference only – always refer to the actual product. If you have any questions about the product and its features, please contact customer service.

## 2. Accessory checklist

	Blanking Plug	x1
	Air Vent	x1
	Washer	x8
	Long Screw	x8
	Masonry Wall Plug	x8
	HOOK	x4
		x4







### 3. Installation notes

- 1) Installation must be completed by a qualified person.
- 2) Dispose of all packaging in a responsible manner.
- 3) For installation, ensure the wall can hold the weight of this product. A brick or cinderblock type wall is suitable.
- 4) This product is for indoors only.
- 5) Use a tape measure to insure there is enough space to fit this product.

### 4. Towel rail installation:

- Read instructions carefully before installation.
- Installation must be completed by a qualified person.
- Dispose of all packaging in a responsible manner.

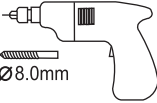
### Tools required



Phillips screwdriver 	PTFE tape(not supplied) 
Slotted screwdriver 	Active spanners 
Marker pen 	Electric drill 
Tape Measure 	8mm Drill Bit  Ø8.0mm

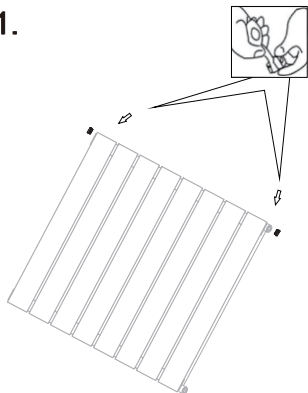

Apply PTFE tape (not supplied) to the blanking plug – insert them into the top left threaded holes. Apply PTFE tape (not supplied) to the air vent plug – insert them into the top right threaded holes.

1.



	Blanking Plug	x1
	Air Vent	x1
	PTFE tape(not supplied)	x1

2.

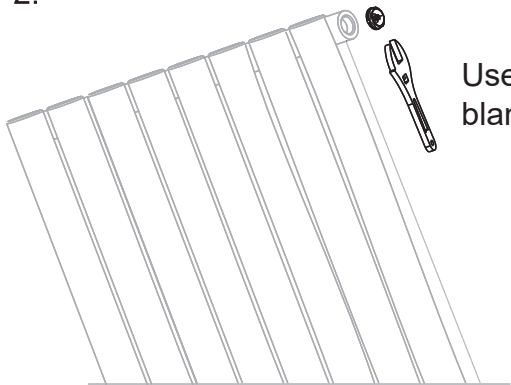





Use a wrench to secure the blanking plug and air vent.

Mark the position of the wall bracket screws with a pencil, then drill 8mm holes into the marked position.  
Tap the masonry wall plug into the hole.

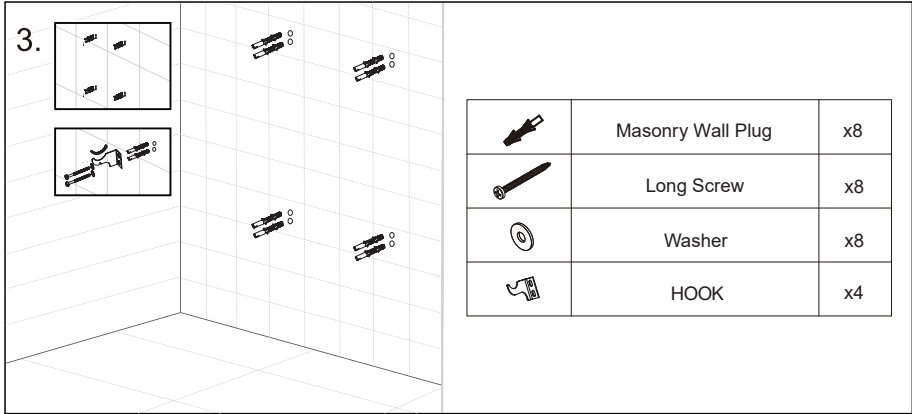
Secure to the wall using a long screw, washer and spencer in that order (hole facing out). See picture below.

3.



	Masonry Wall Plug	x8
	Long Screw	x8
	Washer	x8
	HOOK	x4

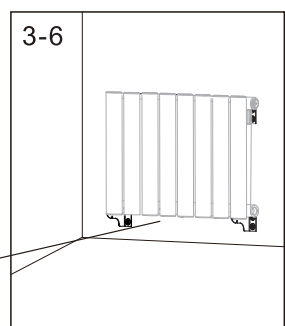
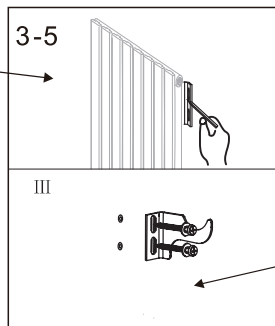
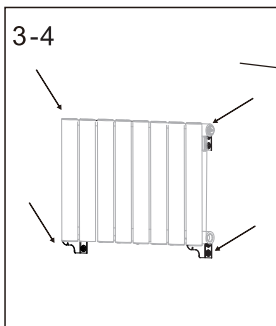
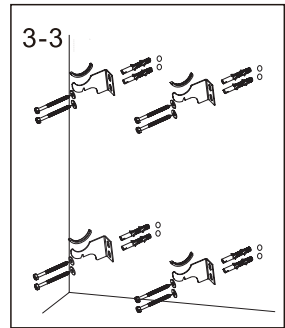
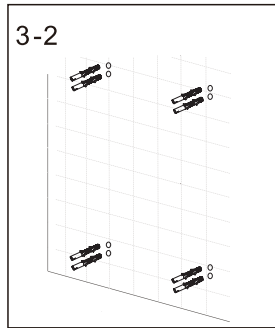
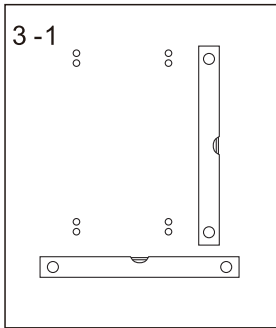

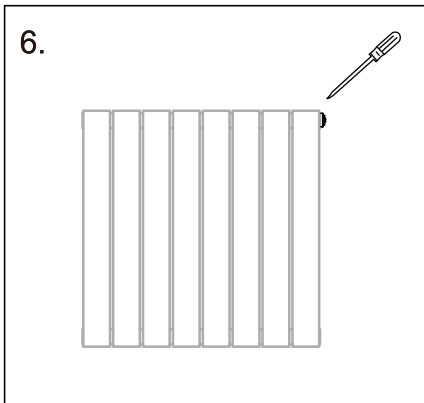
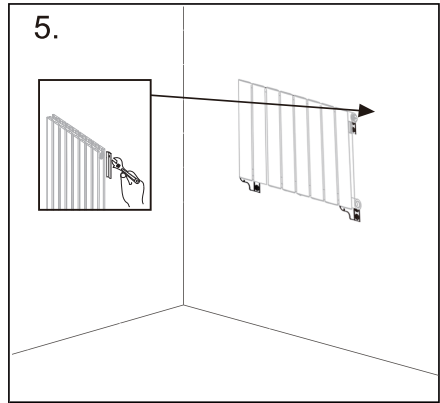
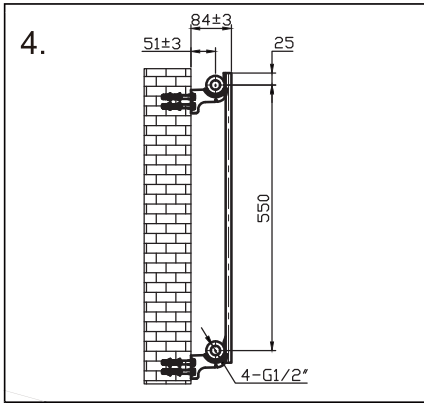

**After installation:**

- Use a screwdriver to open the air vent, open the valve and let the water flow into the product. Check all connection points for possible leaks.
- Once the water flows from the air vent, there will be no air in the tube.
- Use a screwdriver to close the vent, then turn on the valve – the product is ready to use.

**Attention!**

- Inspect the heater regularly. If you find any leaks, close the main valve straight away.
- Be cautious of hot water to prevent scalding.





INcji008V01\_UK\_DE

**820-311V00**

# Badheizkörper

DE

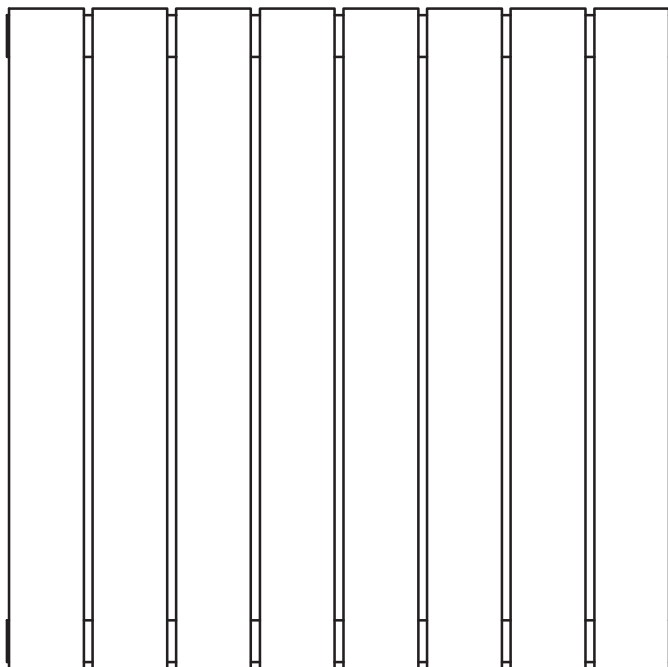

**WICHTIG - BITTE HEBEN SIE DIESE ANLEITUNG FÜR EINE SPÄTERE BEZUGNAHME AUF: SORGFÄLTIG DURCHLESEN**

**GEBRAUCHSANWEISUNG**

Unit:mm

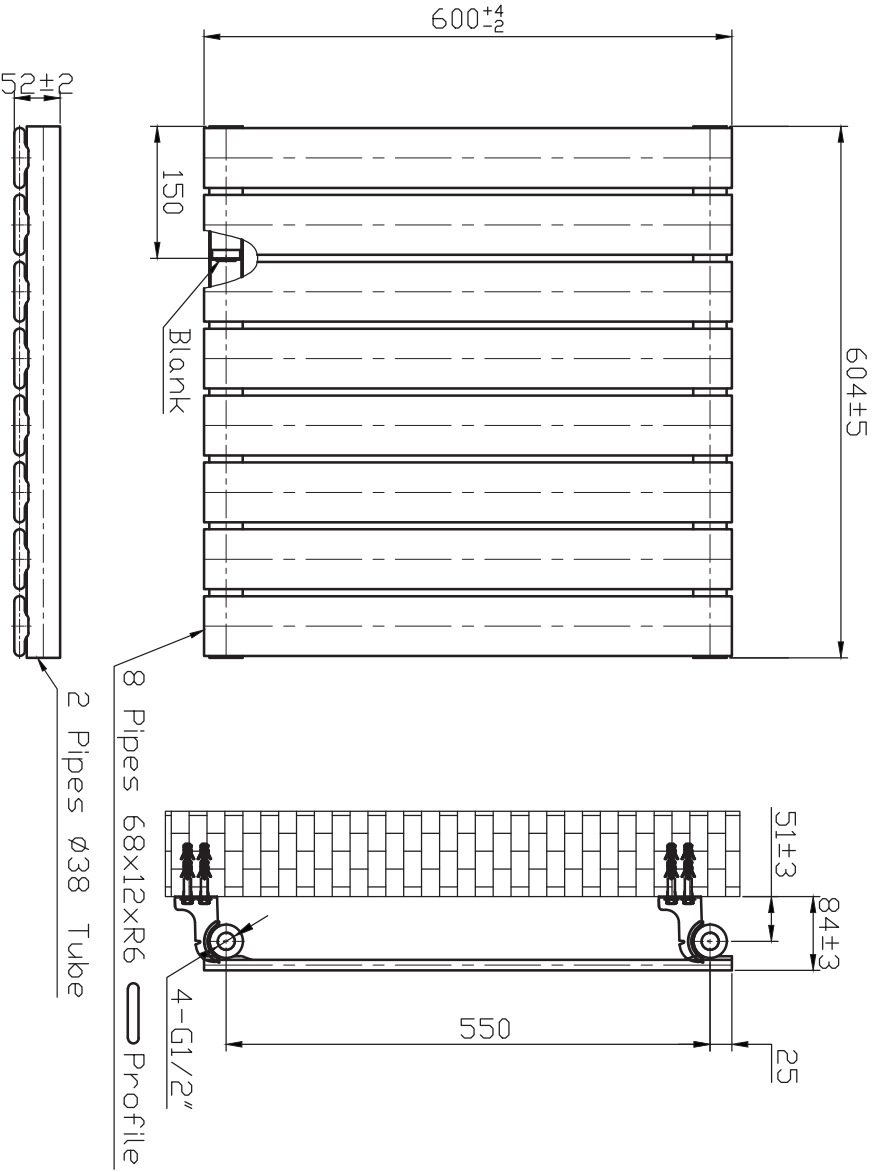

## Sehr geehrter Kunde,

Vielen Dank, dass Sie dieses Produkt erworben haben. Damit Sie dieses Gerät richtig schützen und installieren können, lesen Sie bitte die Bedienungsanleitung vor dem Gebrauch sorgfältig durch. Bewahren Sie diese Anleitung zum späteren Nachschlagen sorgfältig auf.

### 1. Produktmerkmale

Die Bilder in dieser Anleitung dienen nur als Referenz - beziehen Sie sich immer auf das tatsächliche Produkt. Wenn Sie Fragen zum Produkt und seinen Funktionen haben, wenden Sie sich bitte an den Kundendienst.

### 2. Zubehör-Checkliste

	Blindstopfen	x1
	Entlüftung	x1
	Unterlegscheibe	x8
	Lange Schraube	x8
	Dübel für Mauerwerk	x8
	HAKEN	x4
		x4







### 3. Hinweise zur Installation

- 1) Die Installation muss von einer qualifizierten Person durchgeführt werden.
- 2) Entsorgen Sie alle Verpackungen auf verantwortungsvolle Weise.
- 3) Stellen Sie bei der Installation sicher, dass die Wand das Gewicht des Produkts tragen kann. Eine Wand aus Ziegeln oder Betonsteinen ist geeignet.
- 4) Dieses Produkt ist nur für Innenräume geeignet.
- 5) Verwenden Sie ein Maßband, um sicherzustellen, dass genügend Platz für dieses Produkt vorhanden ist.

### 4. Installation des Handtuchhalters:

- Lesen Sie die Anweisungen vor der Montage sorgfältig durch.
- Die Installation muss von einer qualifizierten Person durchgeführt werden.
- Entsorgen Sie alle Verpackungen auf verantwortungsvolle Weise.

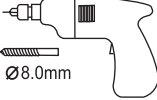
### Erforderliches Werkzeug

Kreuzschlitzschraubendreher 	PTFE-Band (nicht mitgeliefert) 
Schlitzschraubendreher 	Aktive Schraubenschlüssel 
Markierstift 	Elektrische Bohrmaschine 8 mm Bohrer  Ø8.0mm
Maßband 	



PTFE-Band (nicht im Lieferumfang enthalten) auf den Blindstopfen aufbringen und in die oberen linken Gewindebohrungen einführen.  
PTFE-Band (nicht mitgeliefert) auf den Entlüftungsstopfen auftragen und in die oberen rechten Gewindebohrungen einführen.

1.

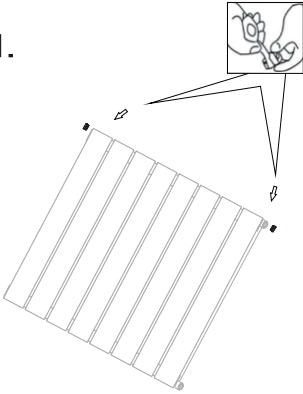

	Blindstopfen	x1
	Entlüftung	x1
	PTFE-Band (nicht mitgeliefert)	x1

2.

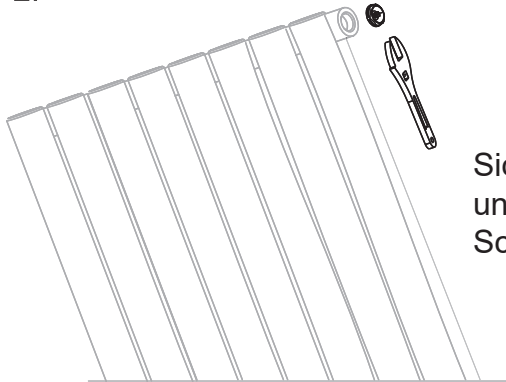

Sichern Sie den Blindstopfen und die Entlüftung mit einem Schraubenschlüssel.

Markieren Sie die Position der Schrauben für die Wandhalterung mit einem Bleistift und bohren Sie dann 8-mm-Löcher in die markierte Position. Klopfen Sie den Mauerdübel in das Loch.

Befestigen Sie ihn mit einer langen Schraube, einer Unterlegscheibe und einer Distanzscheibe in dieser Reihenfolge (mit dem Loch nach außen) an der Wand. Siehe Abbildung unten.

3.

	Dübel für Mauerwerk	x8
	Lange Schraube	x8
	Unterlegscheibe	x8
	HAKEN	x4

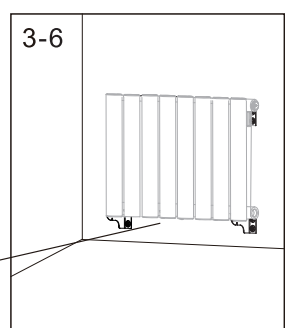
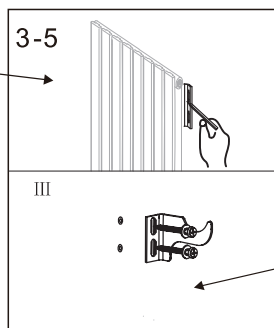
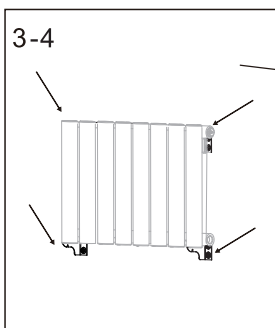
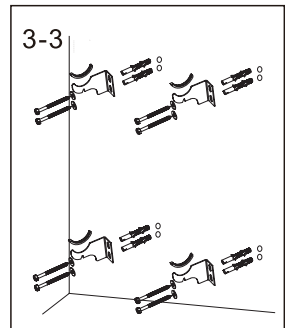
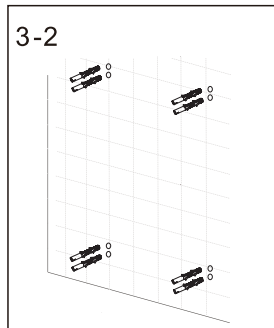
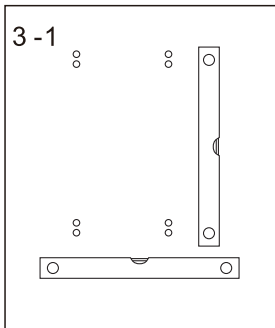

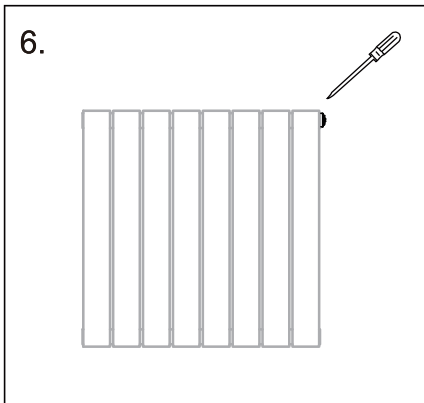
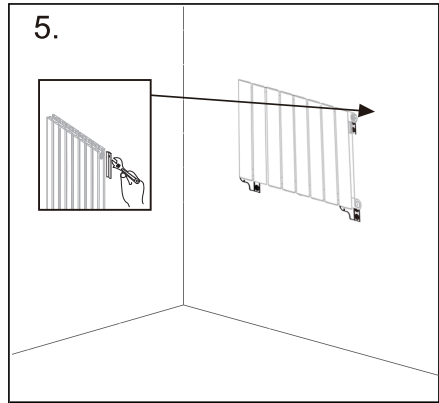
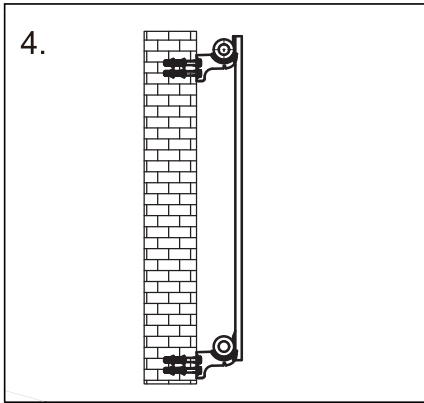

**After installation:**

- Use a screwdriver to open the air vent, open the valve and let the water flow into the product. Check all connection points for possible leaks.
- Once the water flows from the air vent, there will be no air in the tube.
- Use a screwdriver to close the vent, then turn on the valve – the product is ready to use.

**Achtung!**

- Überprüfen Sie den Heizkörper regelmäßig. Wenn Sie ein Leck entdecken, schließen Sie sofort das Hauptventil.
- Seien Sie vorsichtig mit dem heißen Wasser, um Verbrühungen zu vermeiden.

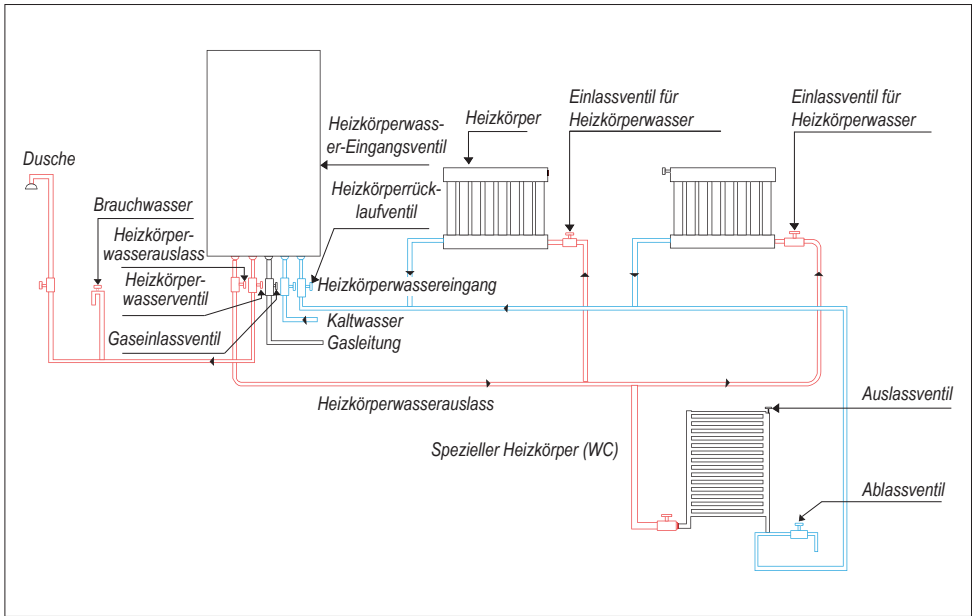

Achten Sie auf die hohe Temperatur der Oberfläche



Nicht zu viele Gegenstände stapeln



Von brennbaren und explosiven Materialien fernhalten