

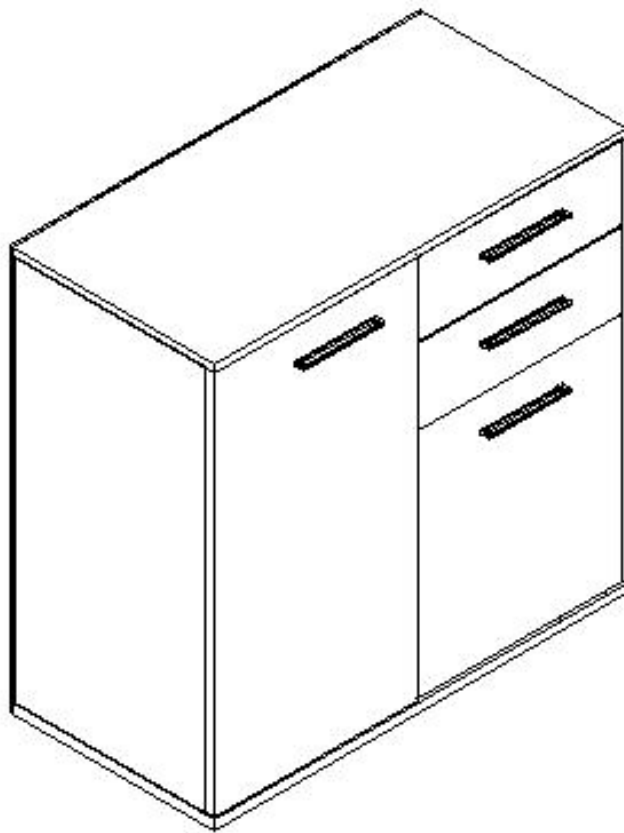





























INcp045\_GL

**02-0672\_02-0673**



**IMPORTANT, RETAIN FOR FUTURE REFERENCE: READ CAREFULLY**



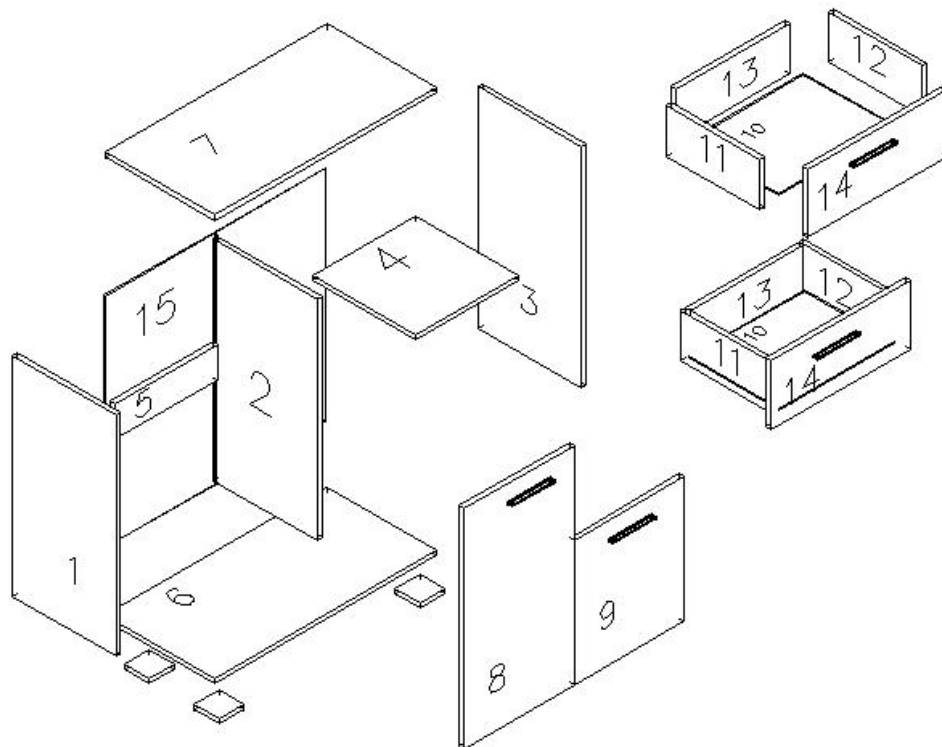

**ASSEMBLY INSTRUCTION**

PARTS LIST			HARDWARE LIST		
NO.	DESCRIPTION	QTY	NO.	DESCRIPTION	QTY
1		1	A		28
2		1	B		28
3		1	C	 M6X30MM	16
4		1	D	 M4.7X38MM	8
5		1	E	 M4X25MM	8
6		1	F	 M3.5X16MM	32
7		1	G	 M3.5X14MM	8
8		1	H	 Neil Pin	34
9		1	I	 M4X18MM	8
10		2	J	 Wooden Leg	4
11		2	K	 Handle	4
12		2	N	 Hinge	4
13		2			
14		2			
15		1			

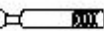

# STEP 1

## HARDWARE LIST

A		M6 8PCS
B		M15 8PCS
C		M6 16PCS
G		M3.5X14 8PCS

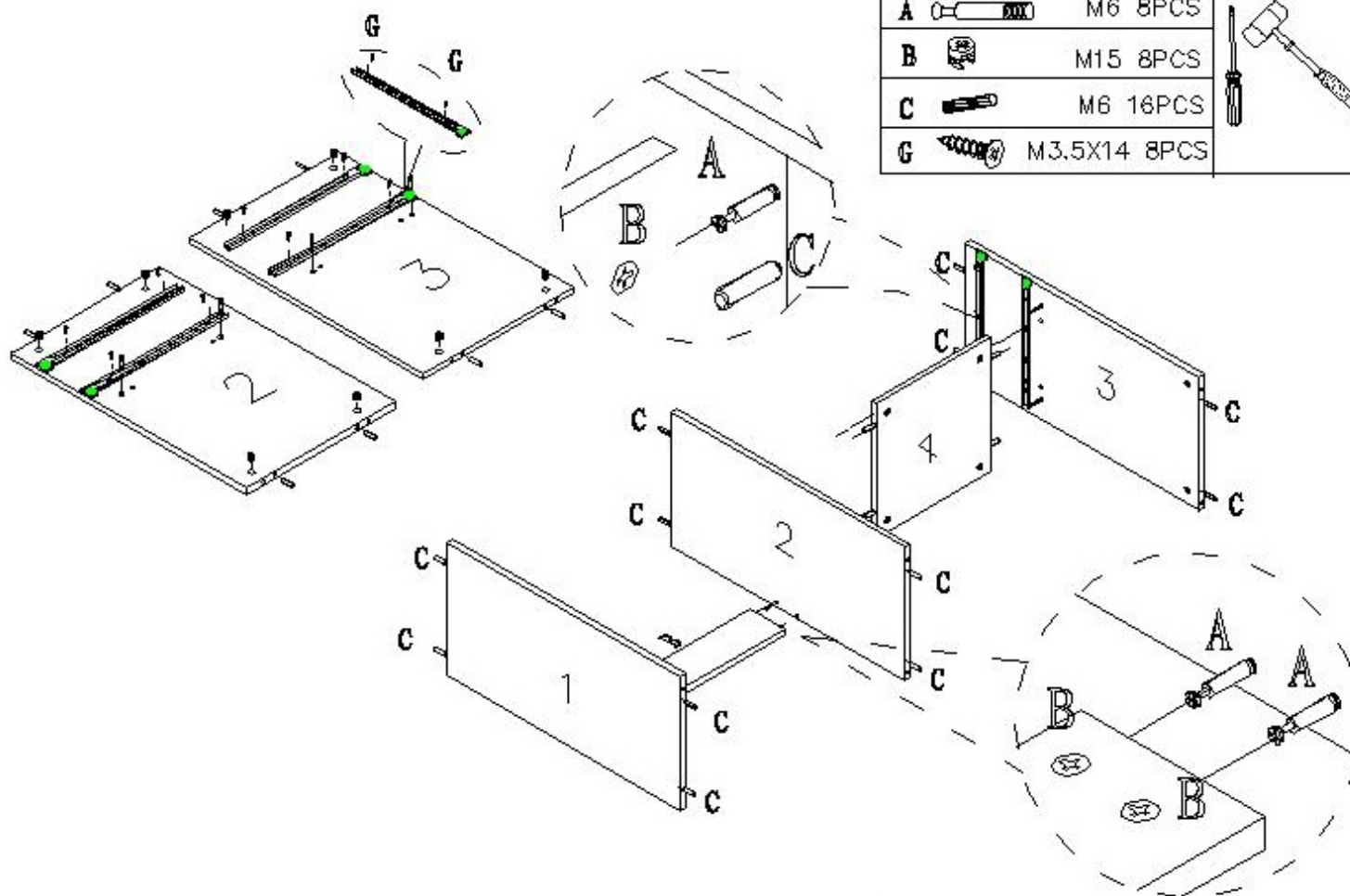

# STEP 3

## HARDWARE LIST

A		M6 6PCS
B		M15 6PCS

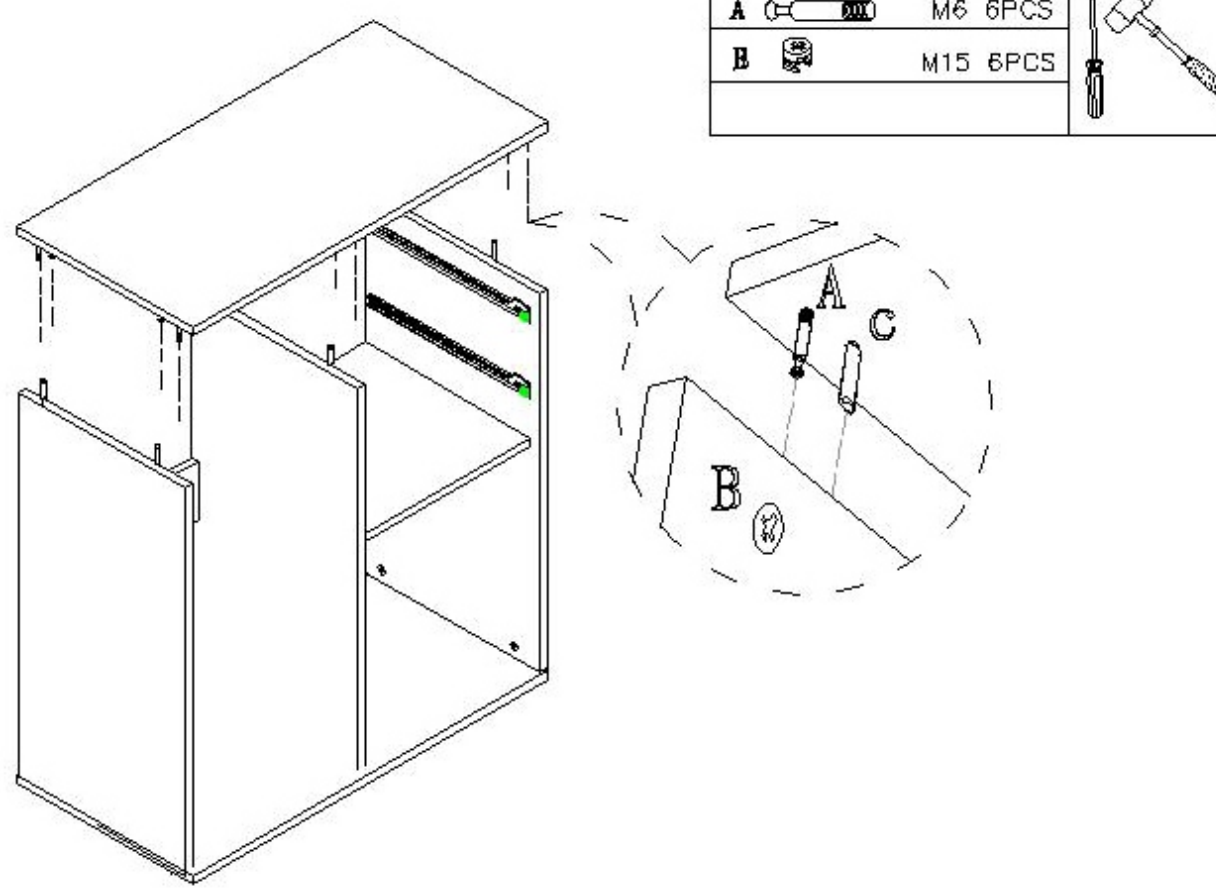

# STEP 2

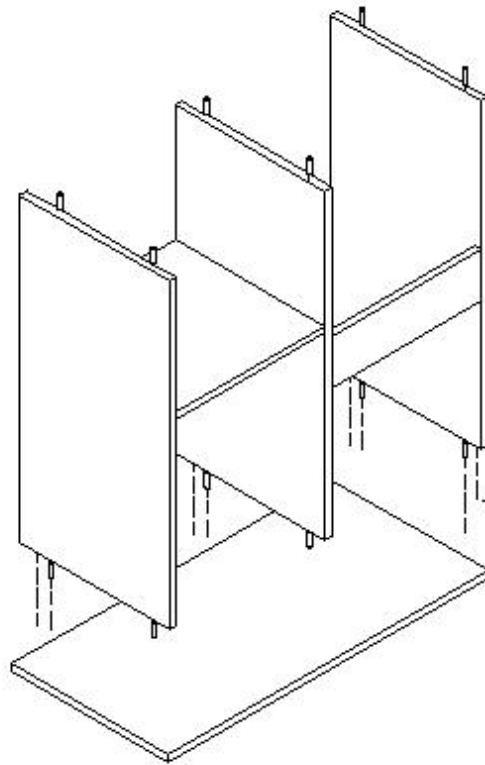

## HARDWARE LIST

<b>A</b>		M6 6PCS
<b>B</b>		M15 6PCS

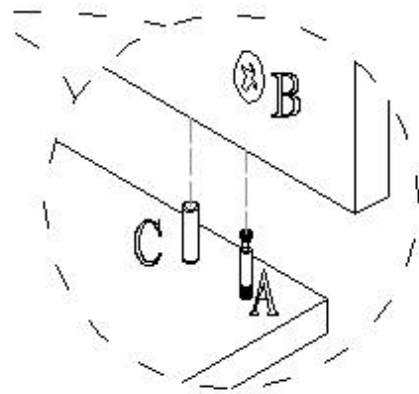

# STEP 4

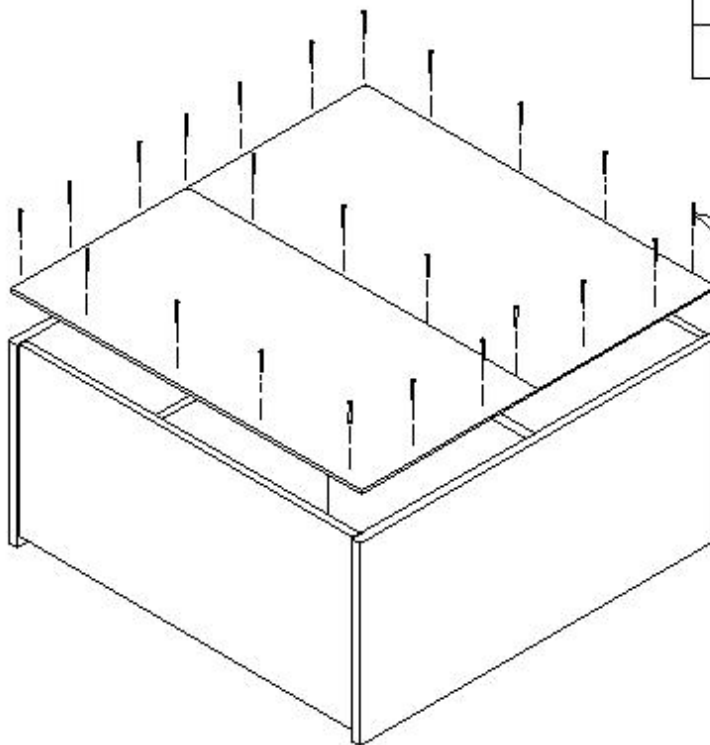

## HARDWARE LIST

<b>H</b>		M1 34PCS
----------	---	----------

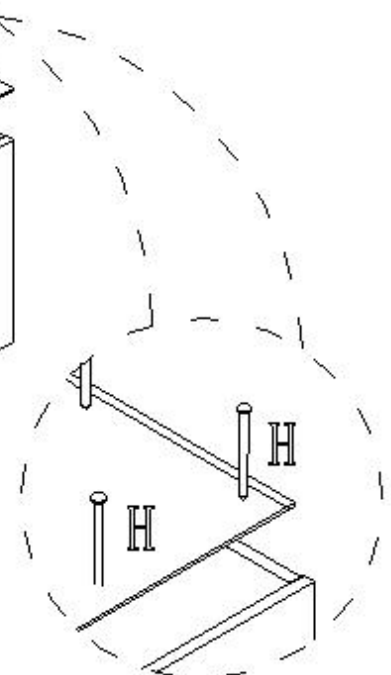

# STEP 5

## HARDWARE LIST

**D**  M3.5 8PCS

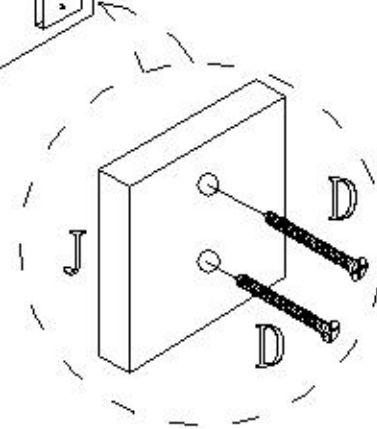
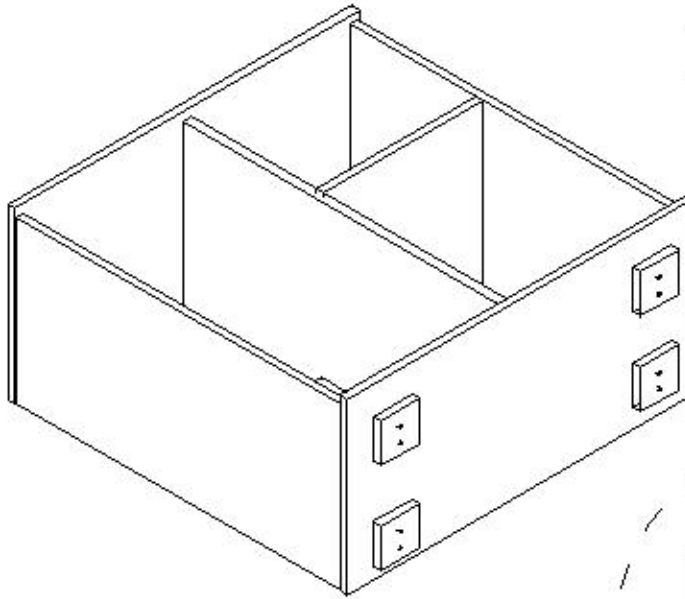
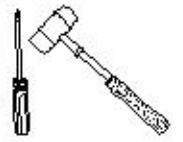

# STEP 6

## HARDWARE LIST

**A**  M6 8PCS

**B**  M15 8PCS

**E**  M4.7 8PCS

**I**  M4X8 4PCS

**F**  M3.5X16 8PCS

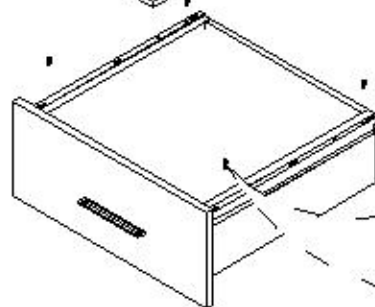
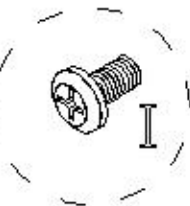
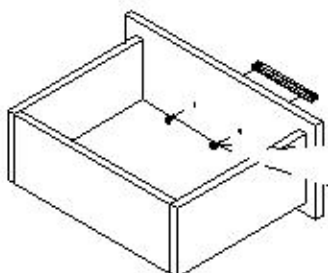
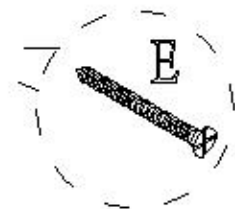
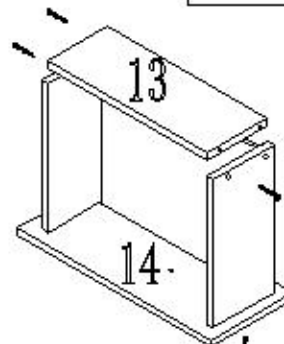
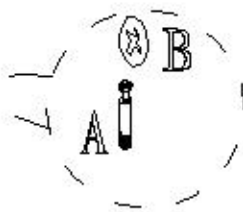
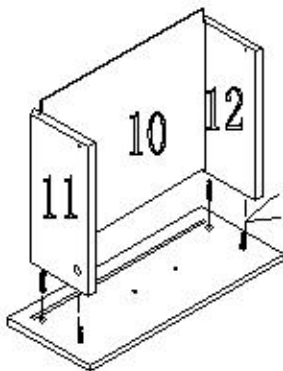
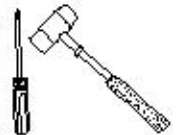

# STEP 7

## HARDWARE LIST

I		M3	8PCS
F		M3.5	24PCS
N			4PCS

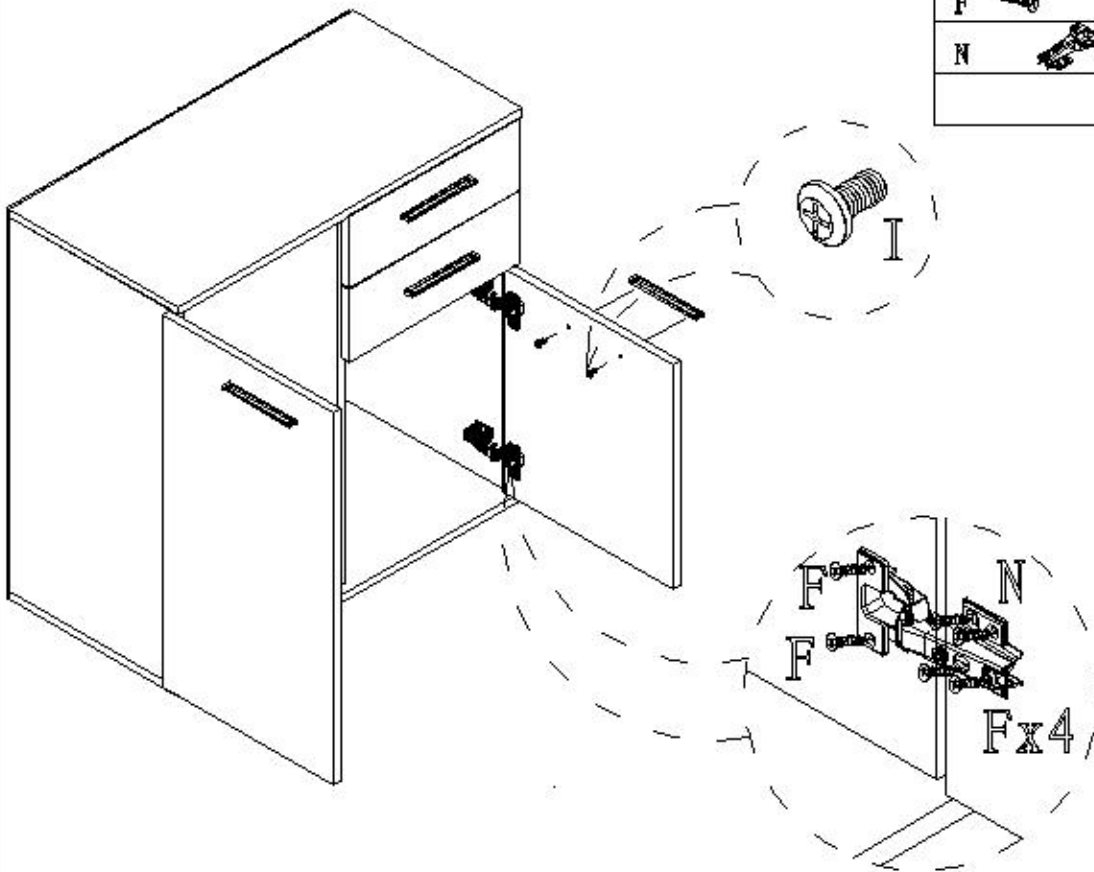
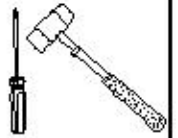

# STEP 8

