

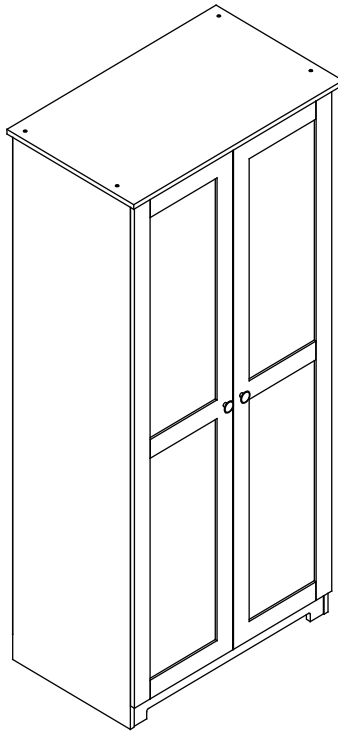

833-595



Please read these instructions and warranty information carefully before use and keep them properly for future reference.





OPERATING INSTRUCTIONS

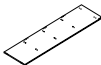
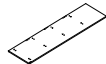
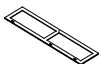
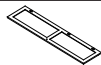
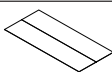



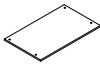







# PACKING DETAILS: TOTAL 2 BOXES

## BOX 1/2:

PART NO.	PARTS	QTY
2		x1
3		x1
8		x1
9		x1
10		x2

## BOX 2/2:

PART NO.	PARTS	QTY
1		x1
4		x3
5		x3
6		x1
7		x1

PART NO.	PARTS	QTY
A		x28
B		x28
C		x30
D		x4
E		x24
F		x4
G		x32
H		x6
I		x1
J		x2
K		x2
L		x14

# Assembly Instructions

1

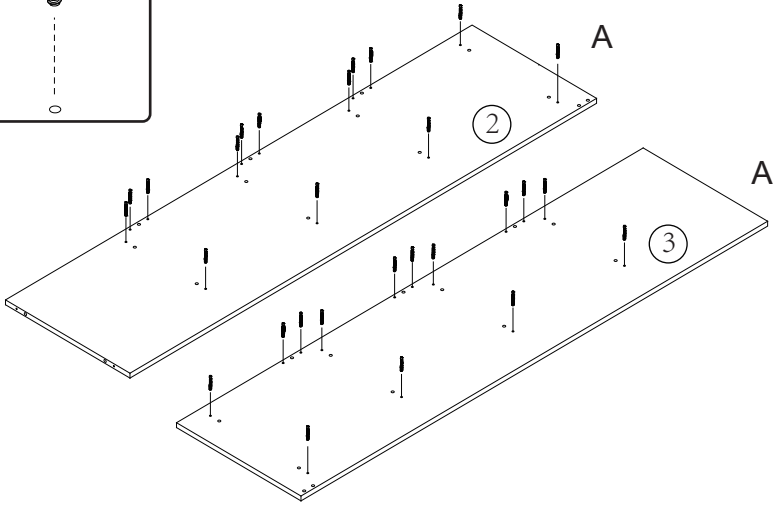
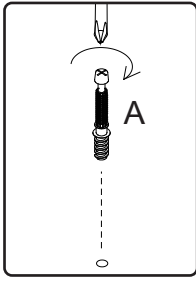

2

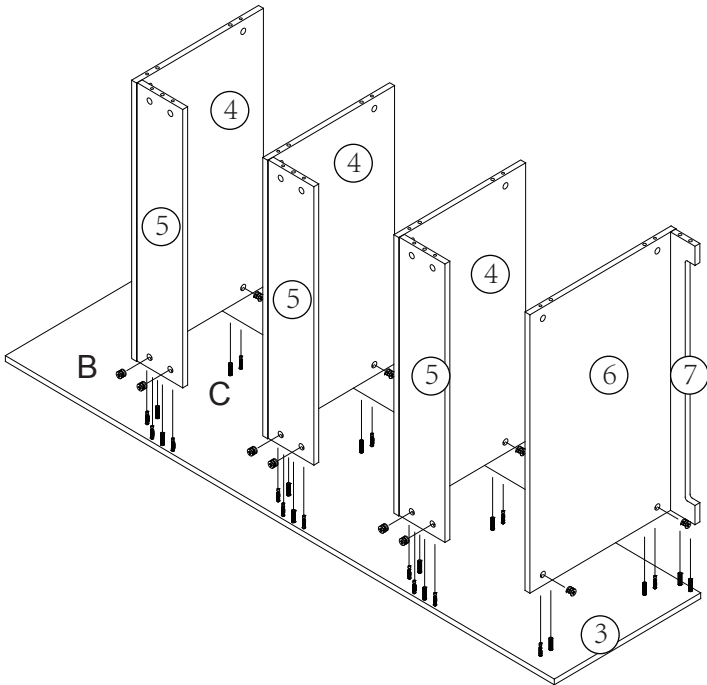



# Assembly Instructions

**5**

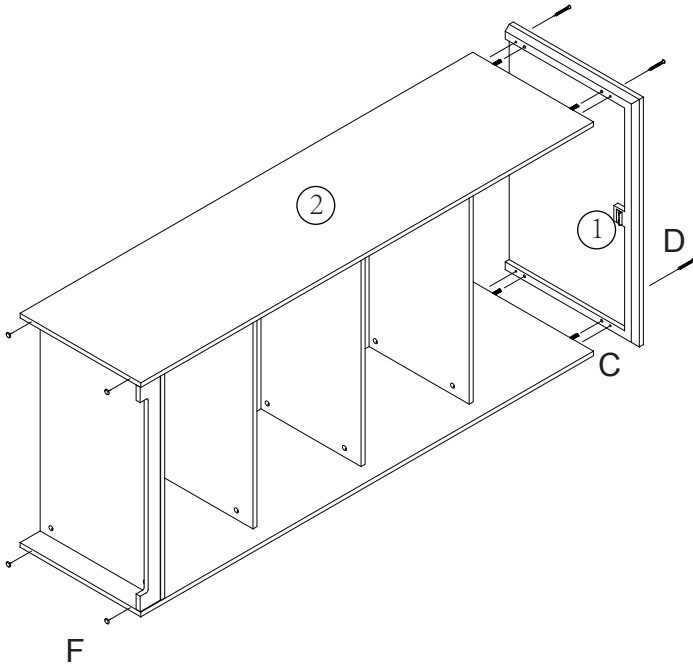

**6**

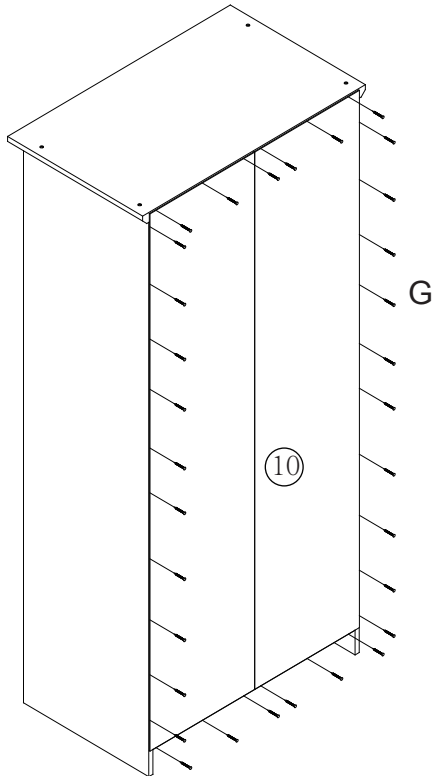

# Assembly Instructions

## 7

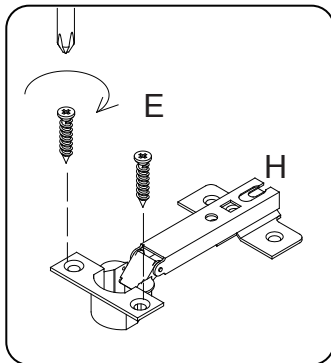
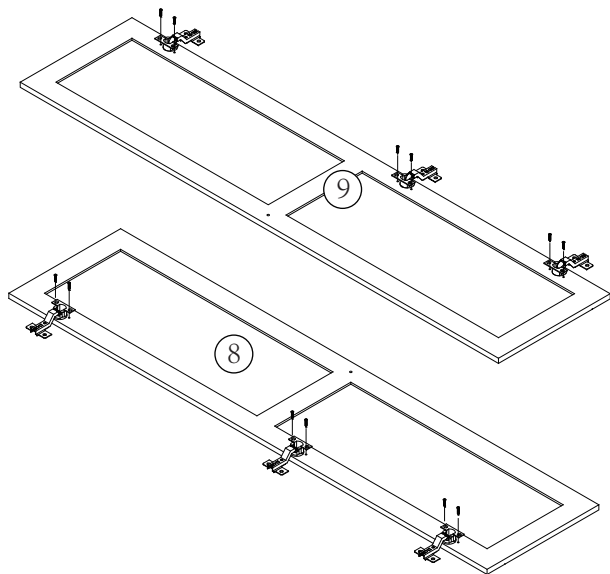

## 8

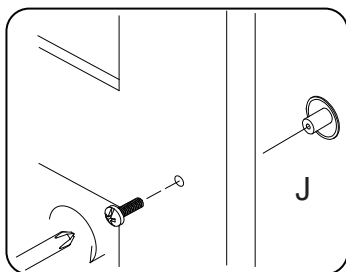
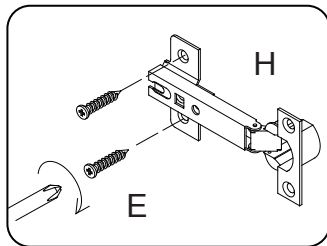
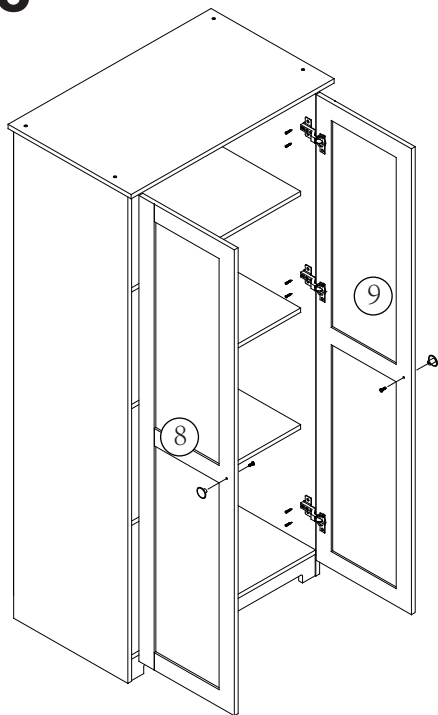

# Assembly Instructions

## 9

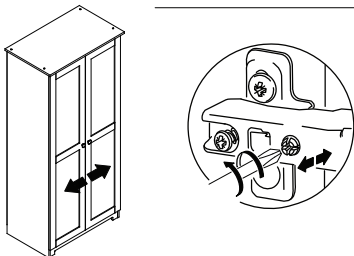
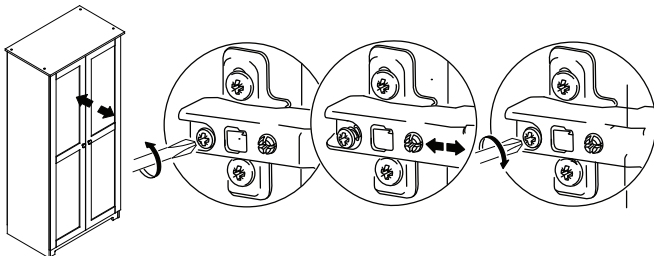
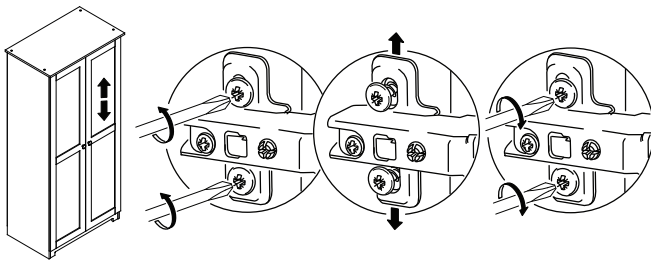

## 10

