

833-422

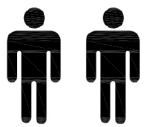

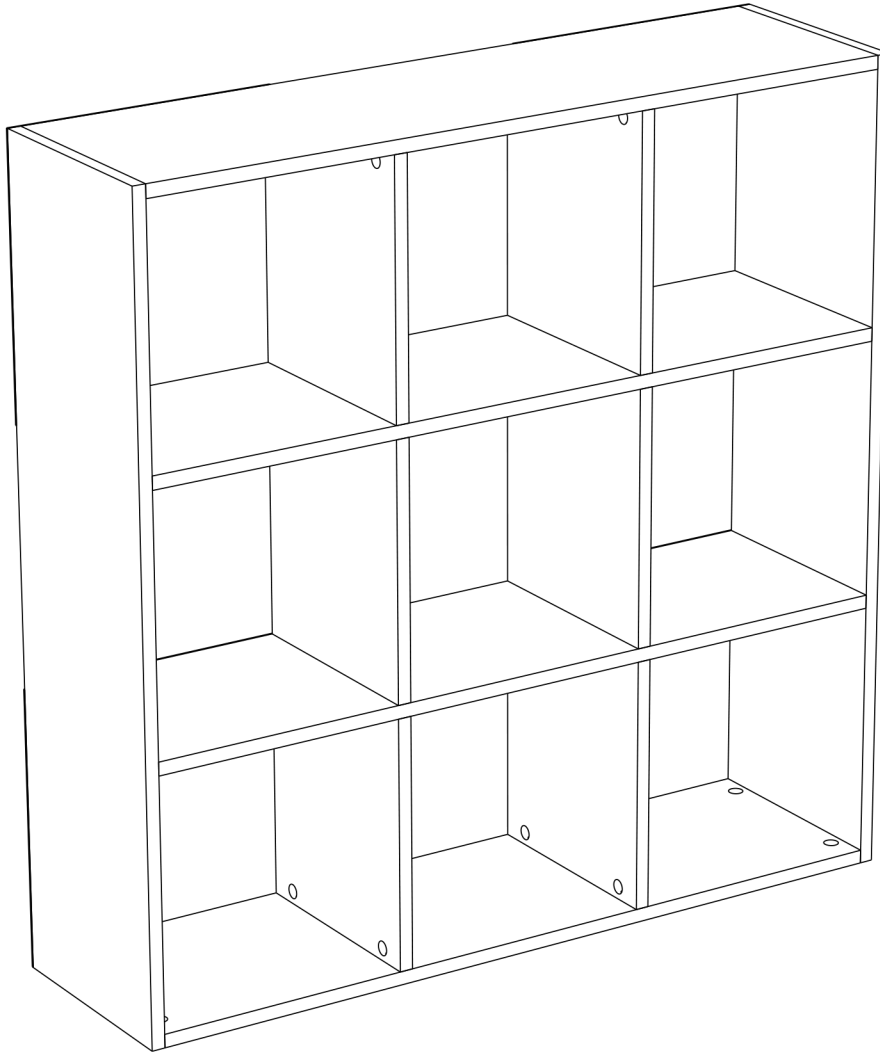

2 PERS.

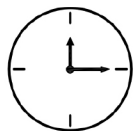

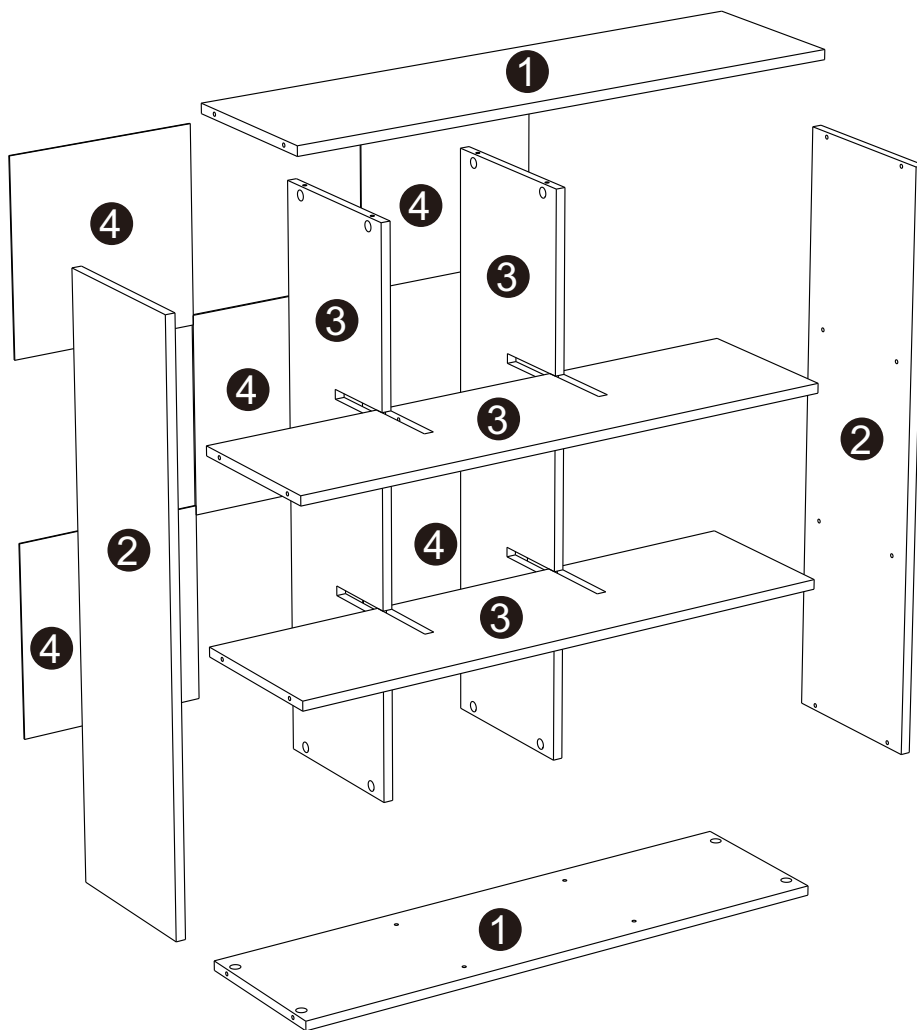
60 MIN

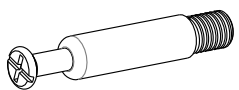

A	x27
	

B	x27
	

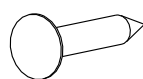
C	x63
	

1

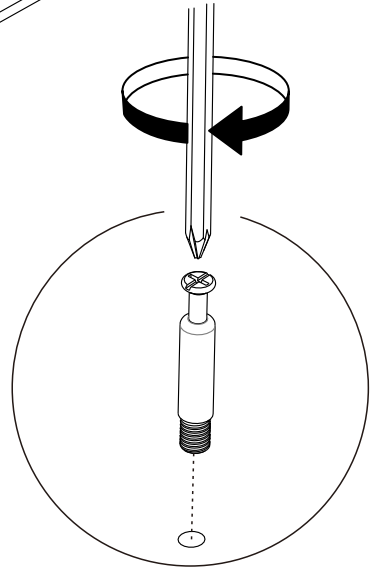
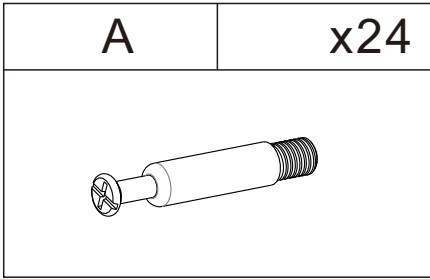
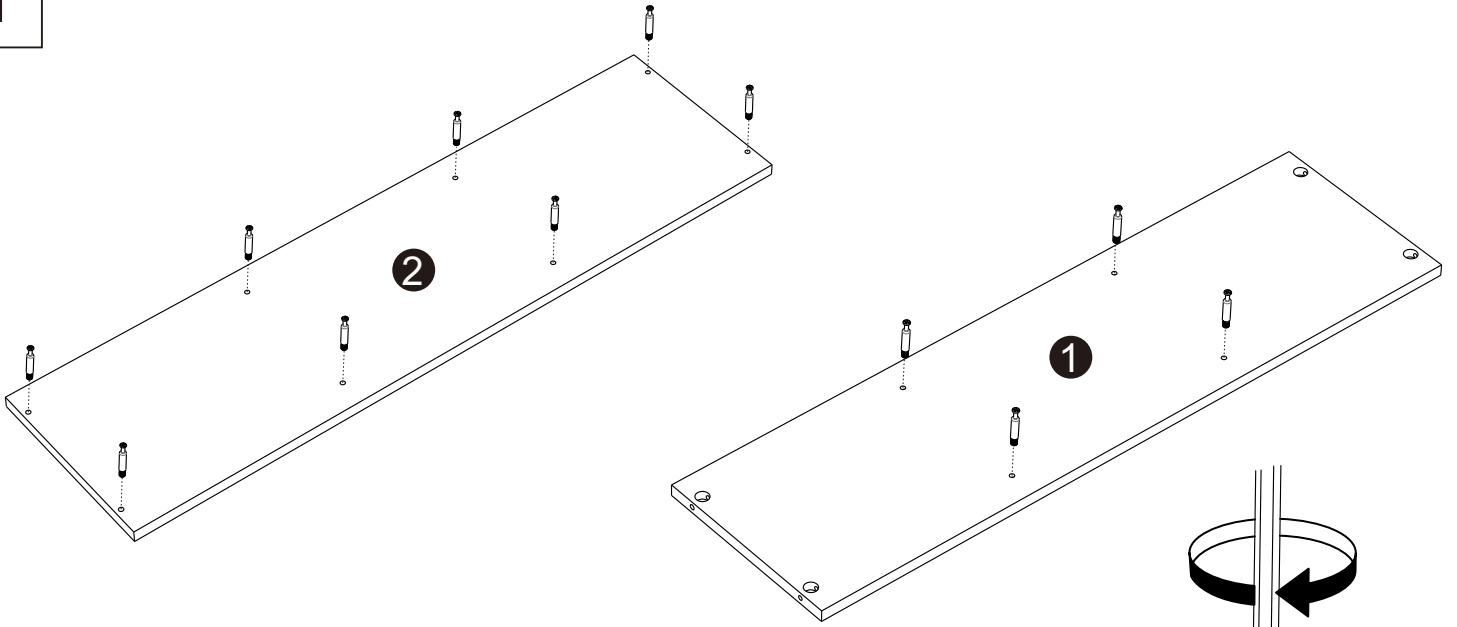

2

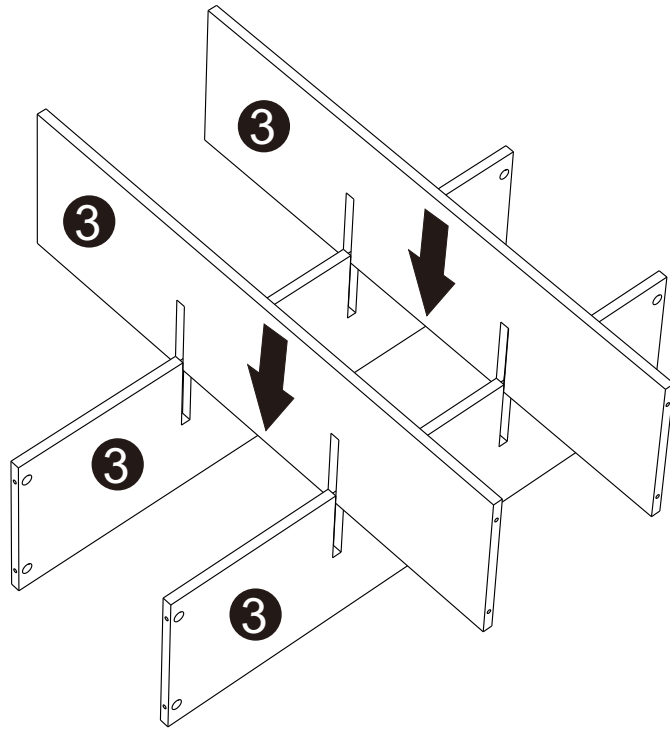

3

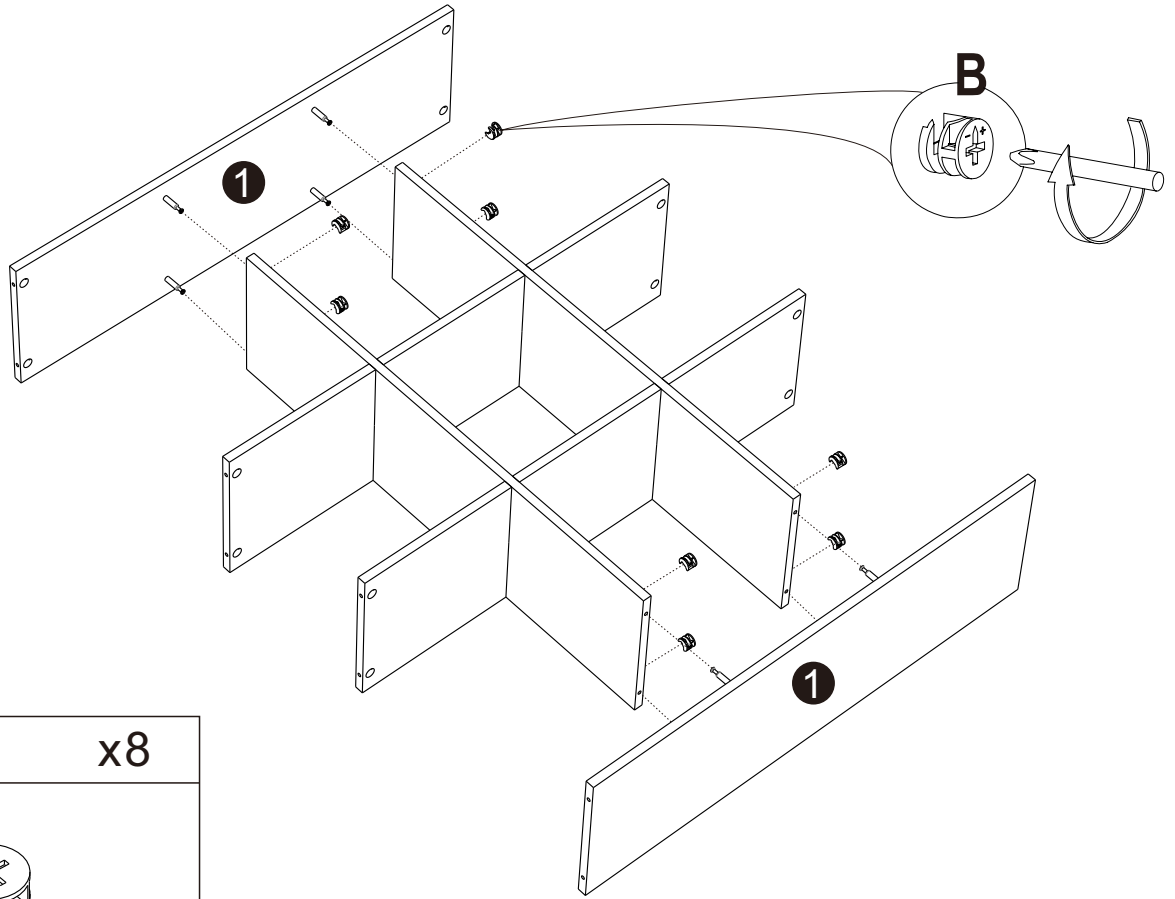

B	x8

4

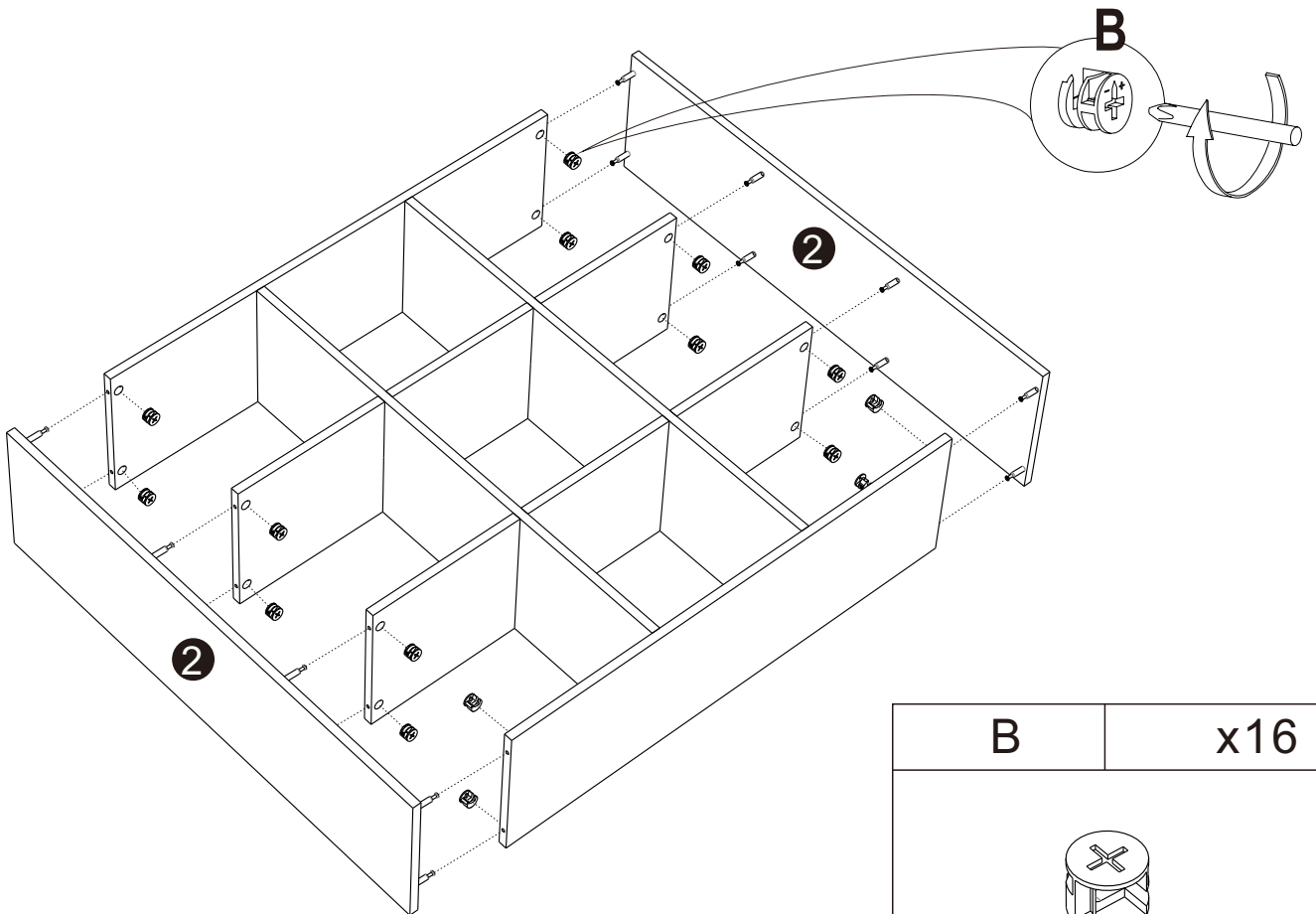

B	x16

5

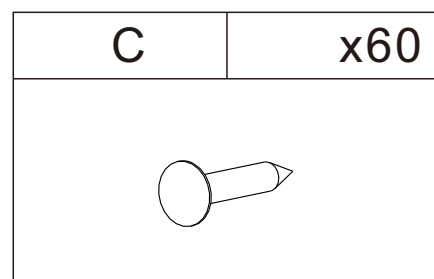
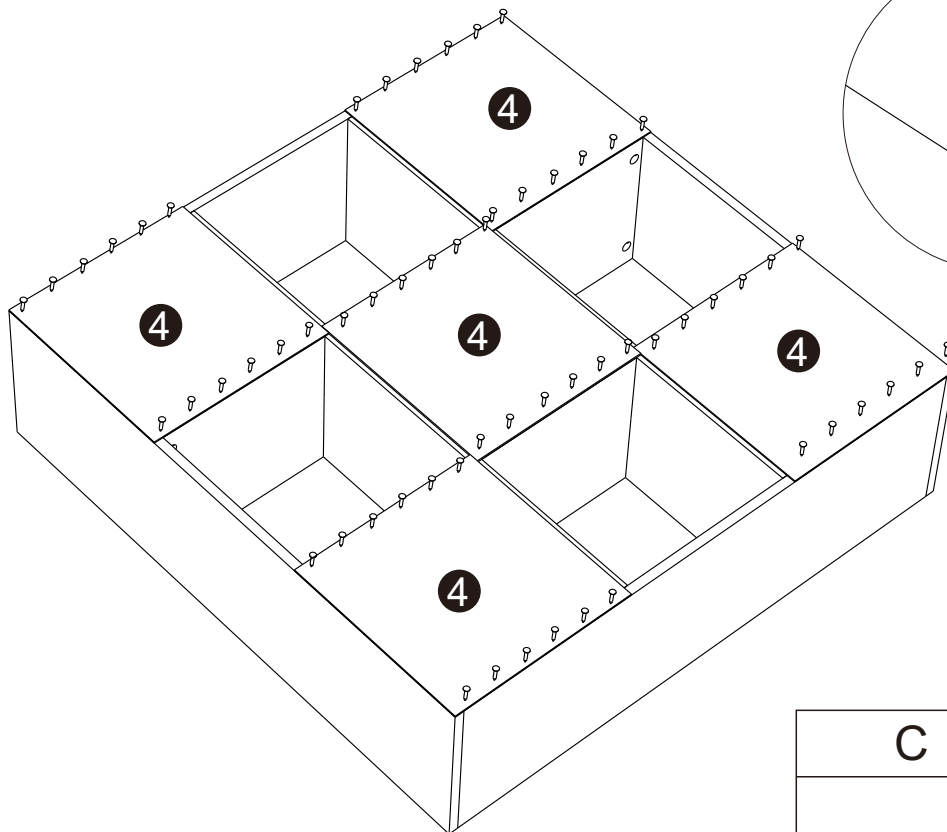

6

