

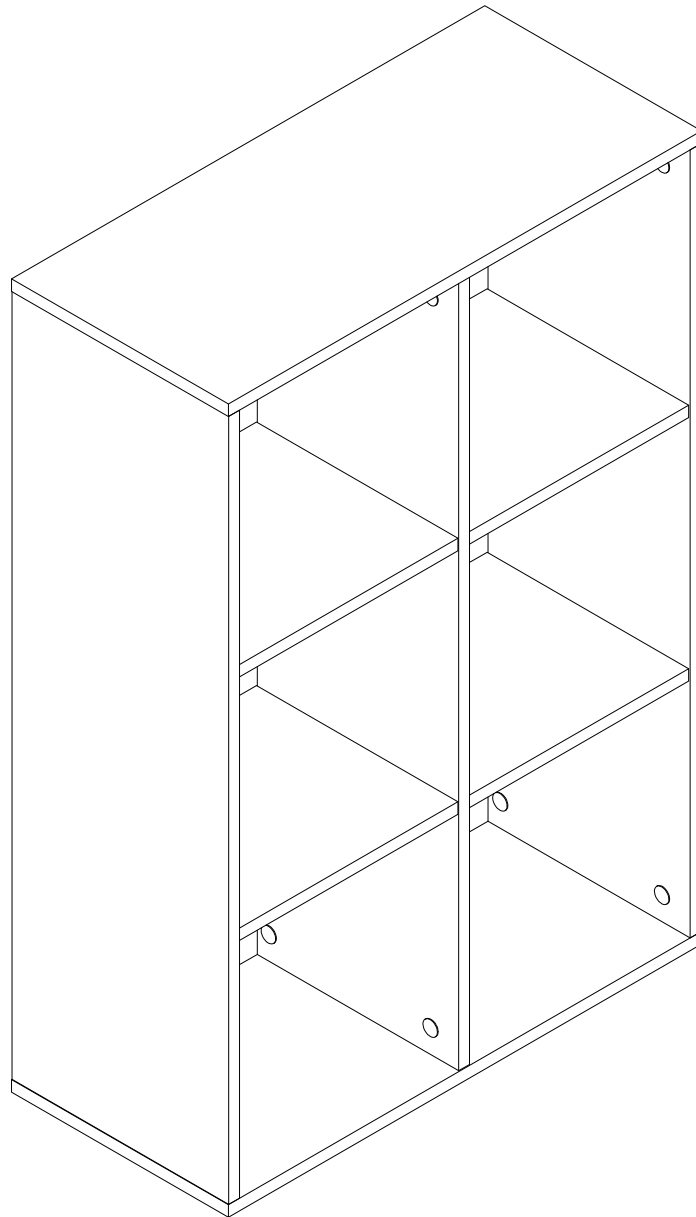

INcqd042\_GL

**836-369**



READ AND SAVE THIS INSTRUCTIONS FOR FUTURE USE

**ASSEMBLY & INSTRUCTION MANUAL**

PACKING DETAILS: TOTAL 1 BOX

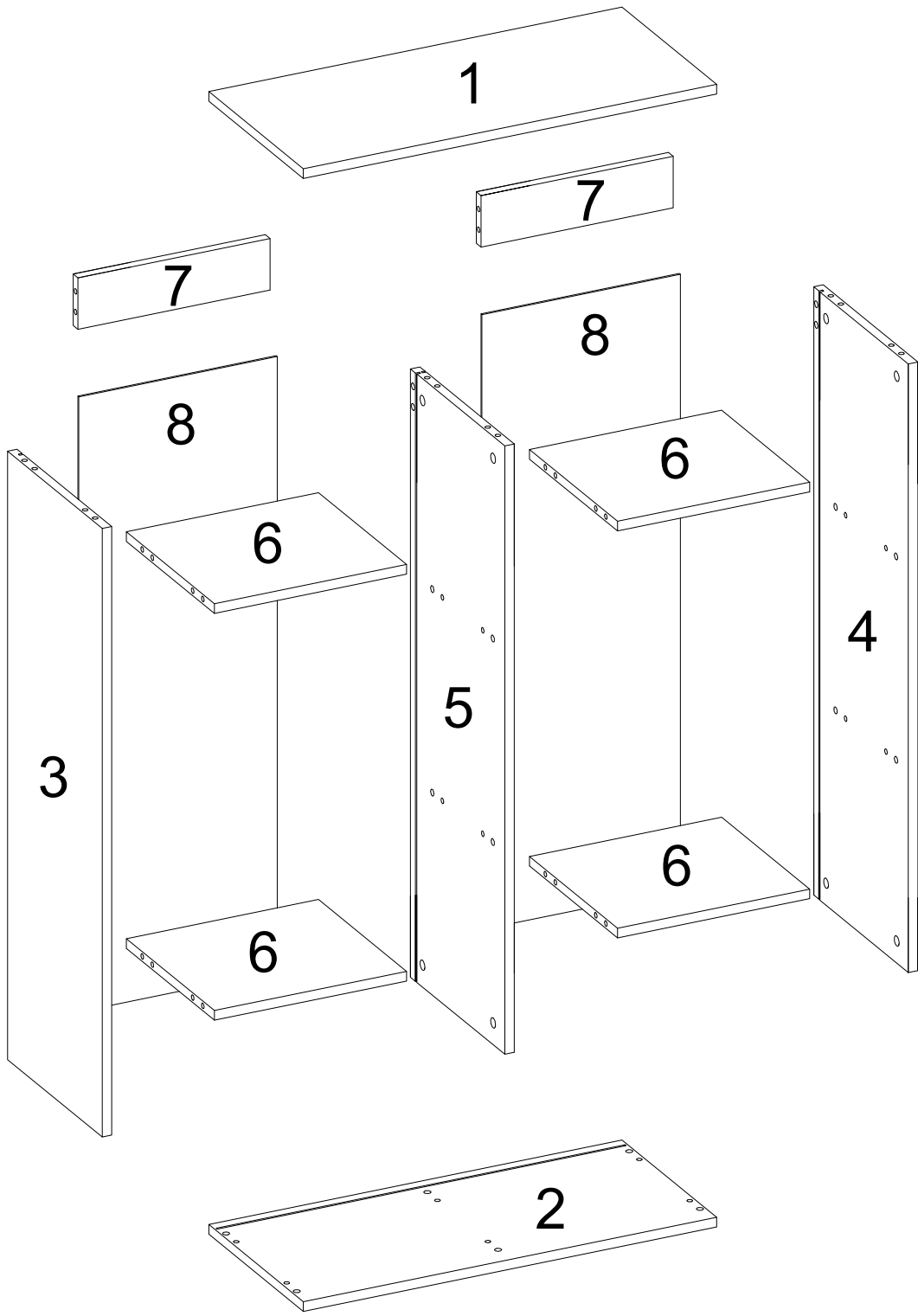

**A**

X36

**B** M8\*30

X20

**C** M8\*50

X4

**D** M3.5\*14

X8

**M**

X8

**T**

X36

**W**

X1

1

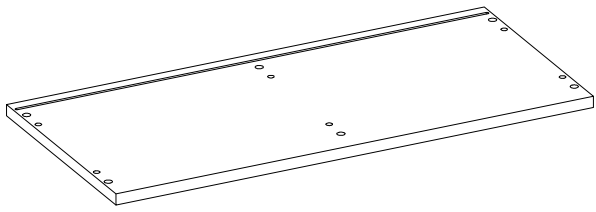

655\*300mm

2

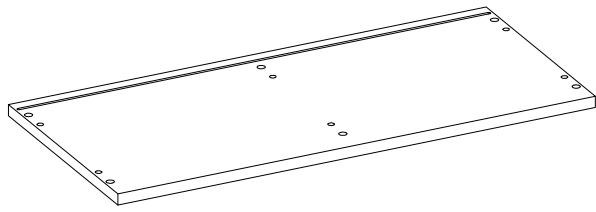

655\*300mm

3

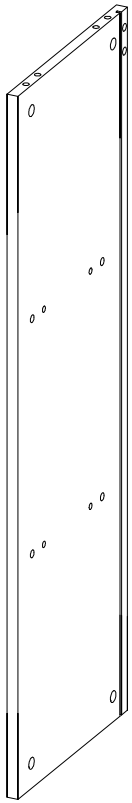

945\*300mm

4

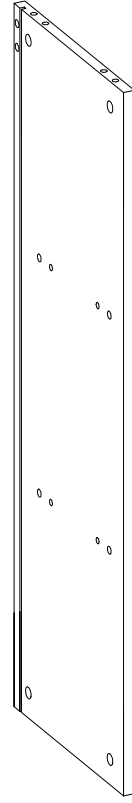

945\*300mm

5

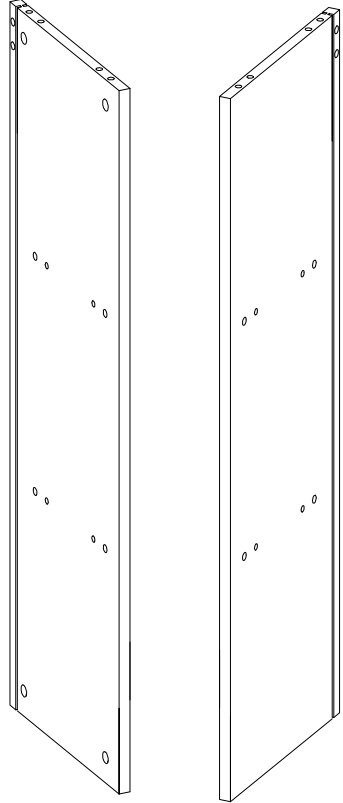

one side

other side

945\*299mm

6

X4

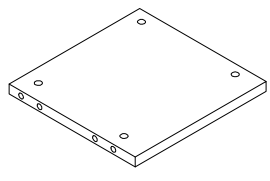

304.5\*278mm

8

X2

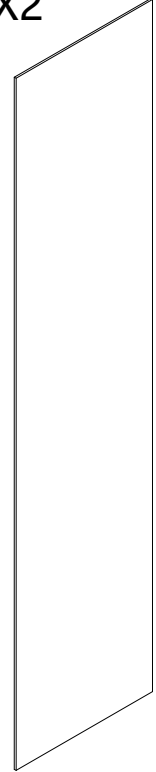

955\*313.5mm

7

X2

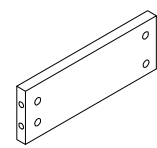

304.5\*80mm

1

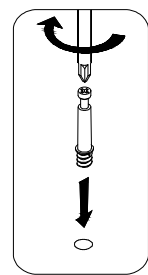
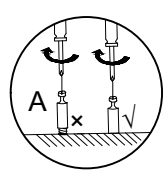
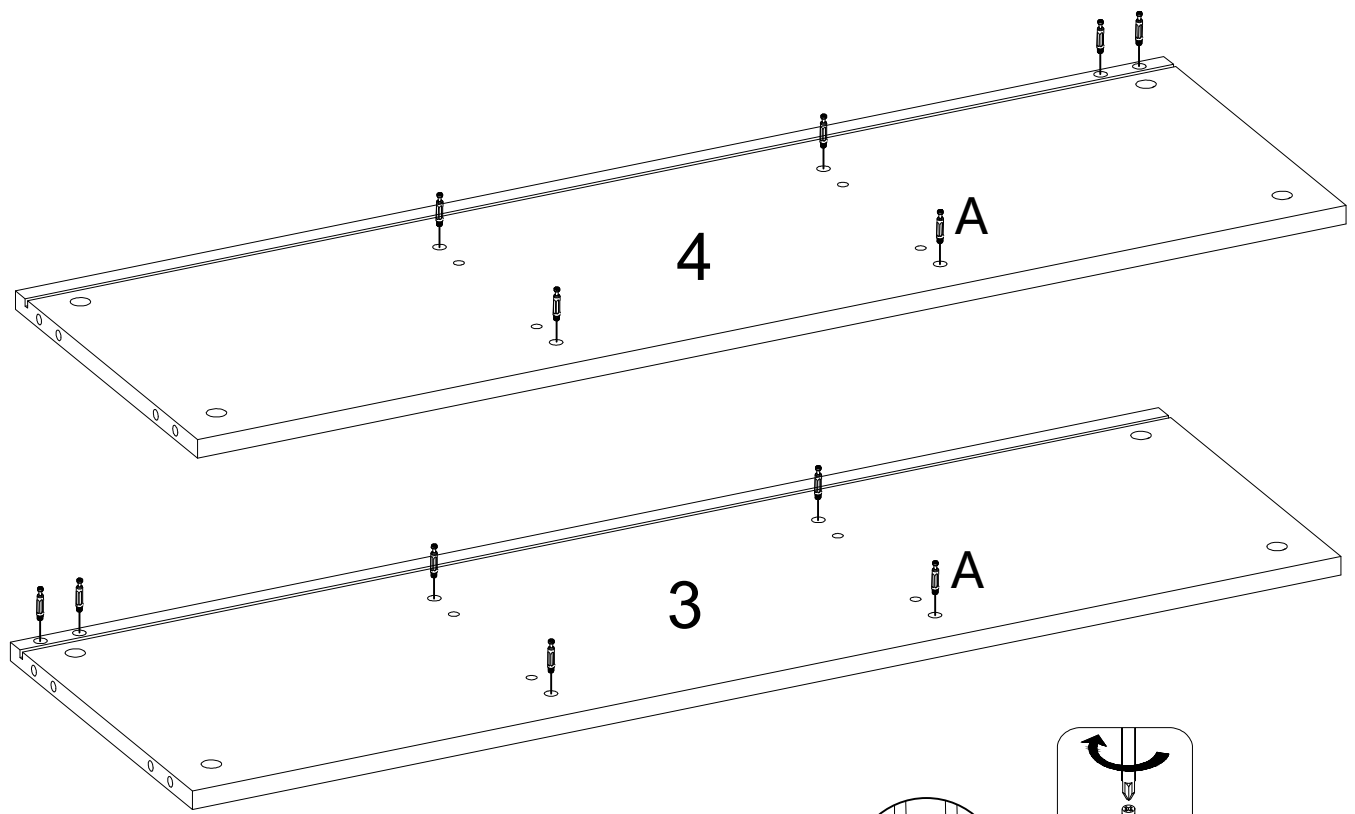

A X12

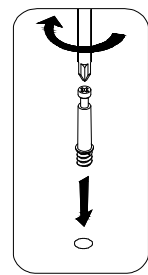
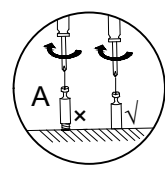
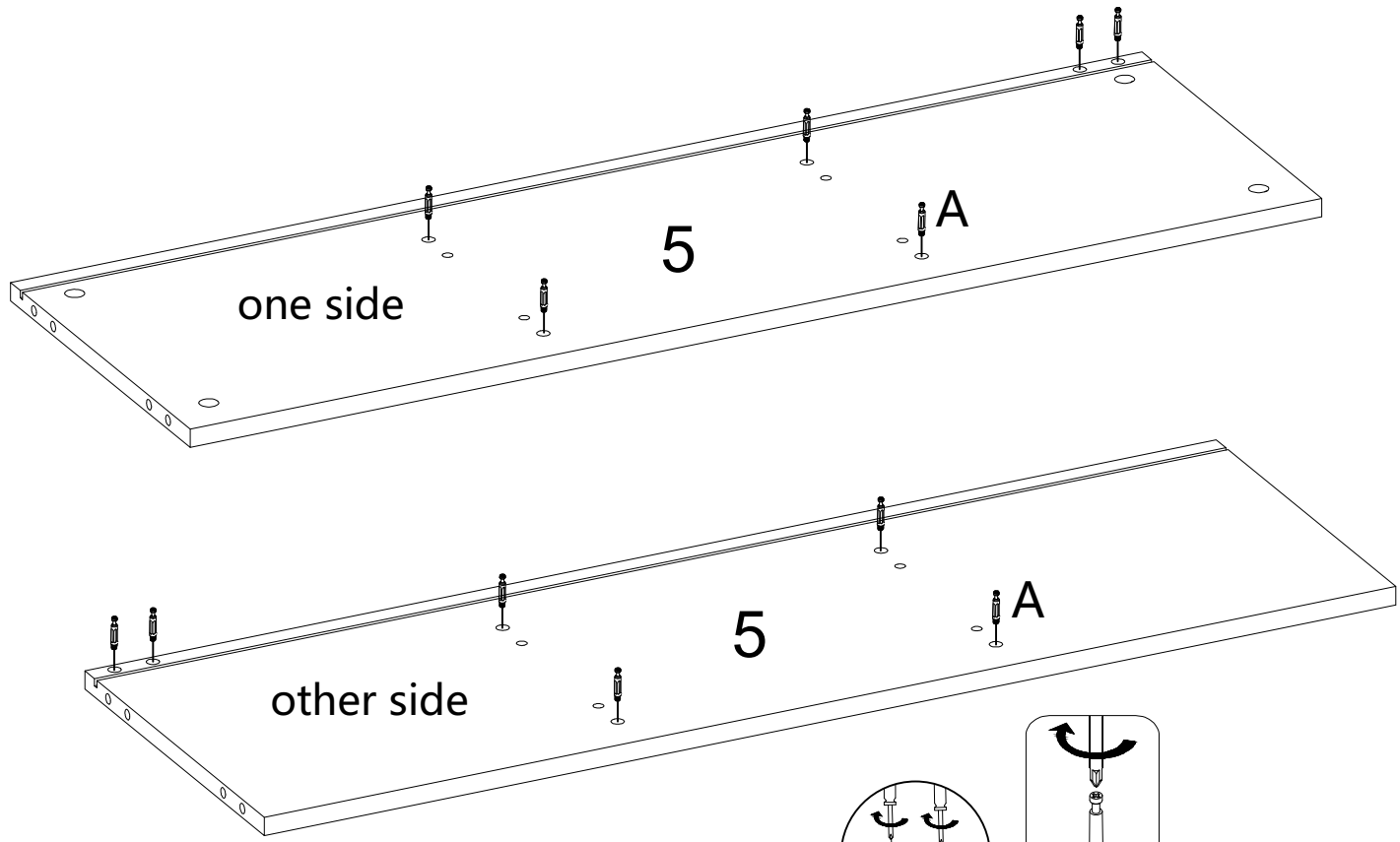

2



A X12

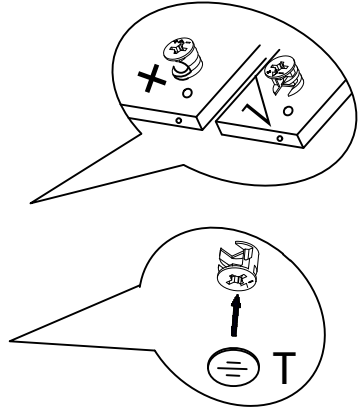
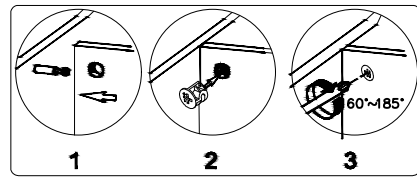
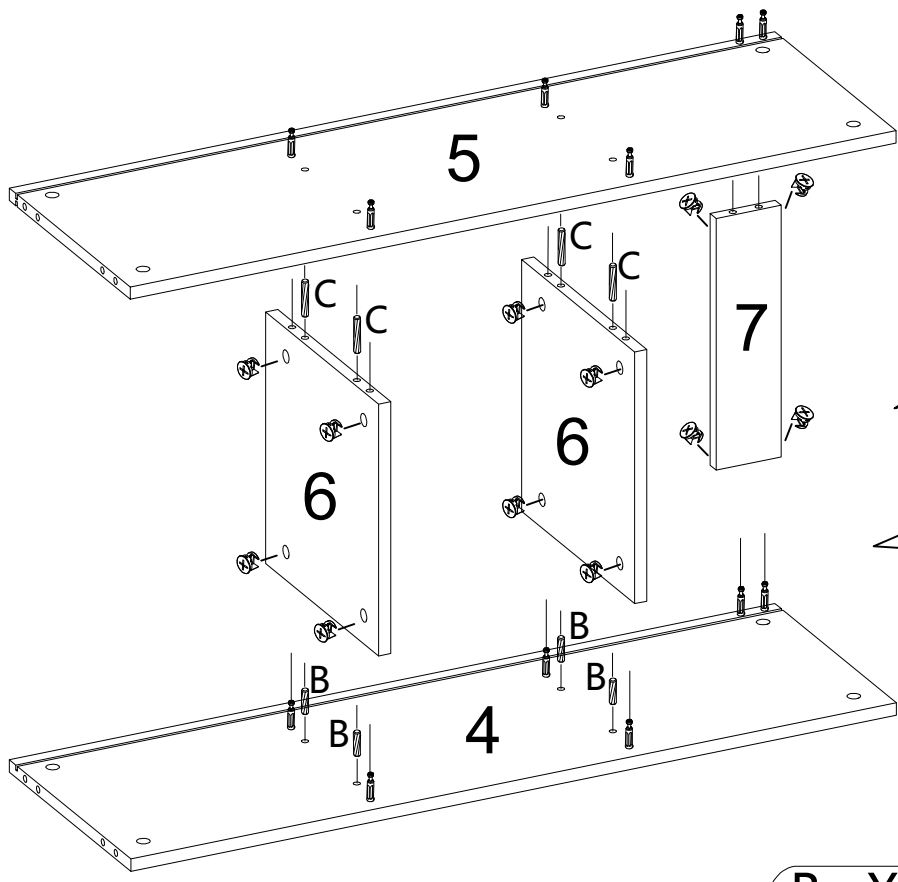

3

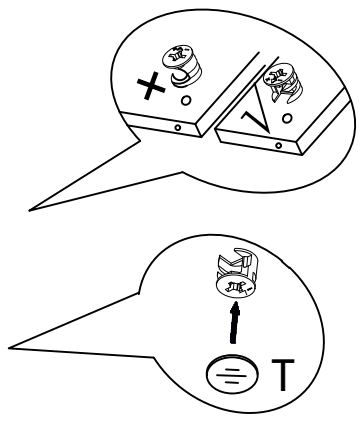
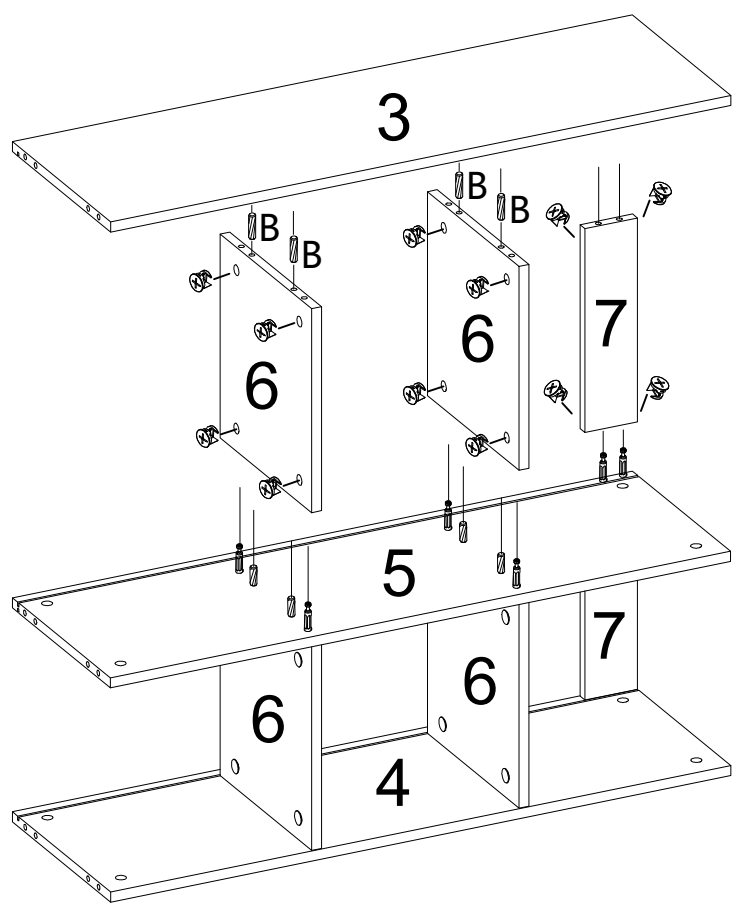

B X4	C X4	T X12
		

4



B X4	T X12
	

5

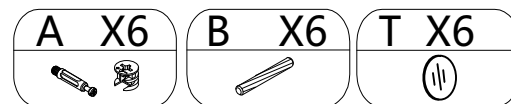
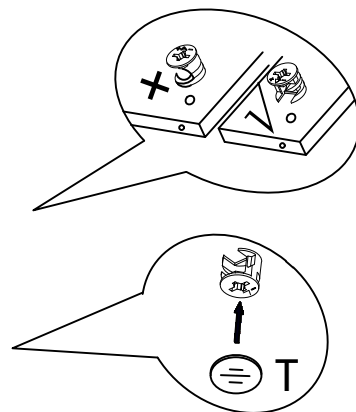
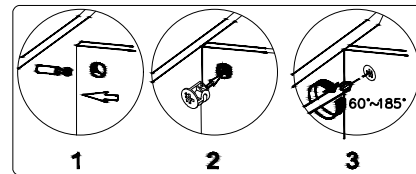
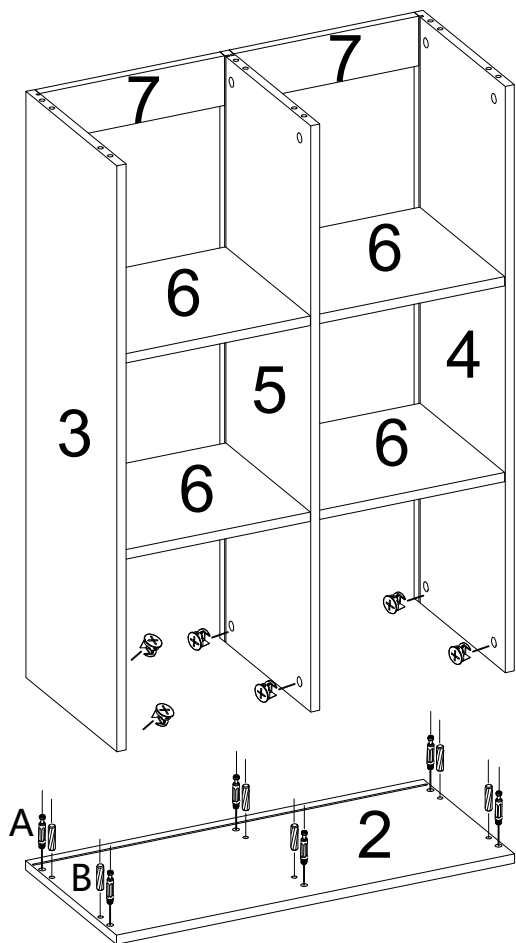
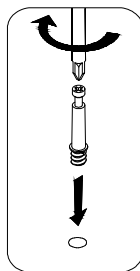
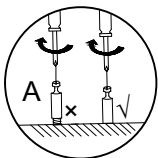

6

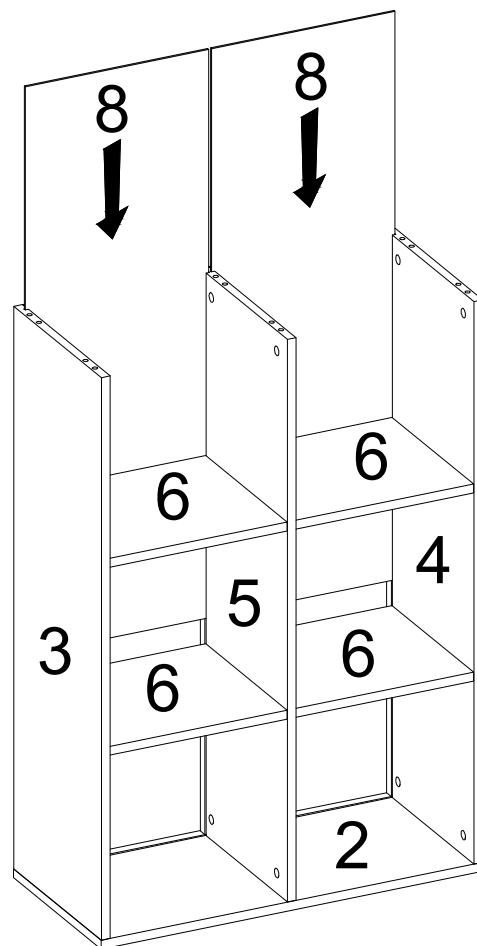

7

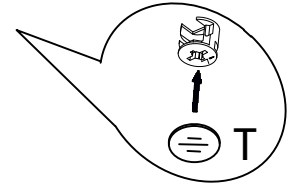
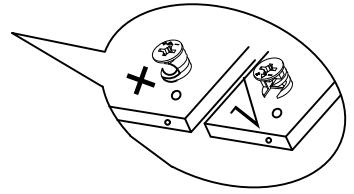
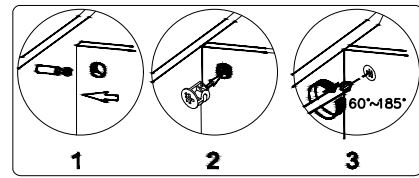
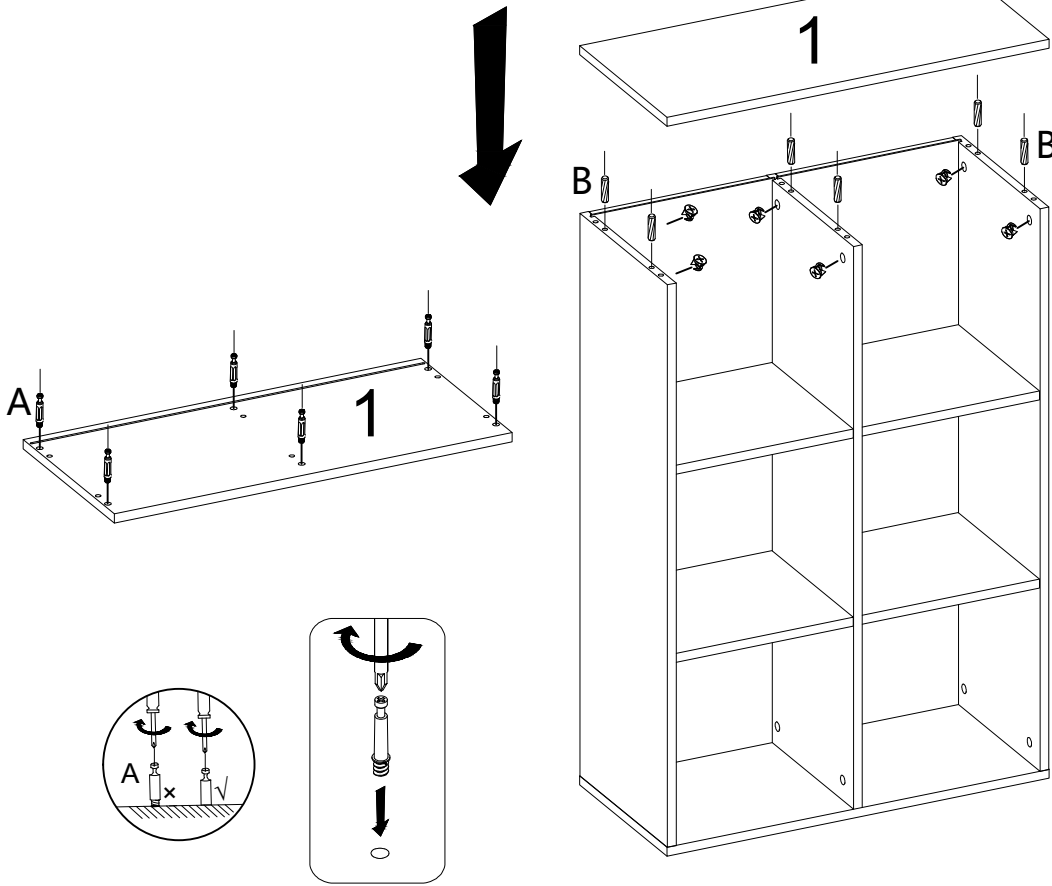

A X6	B X6	T X6

8

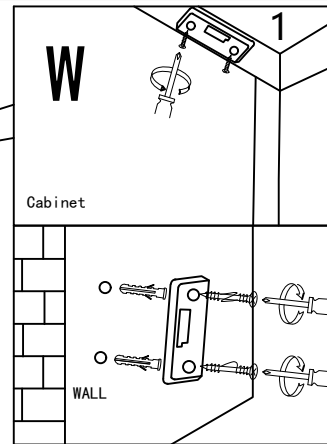
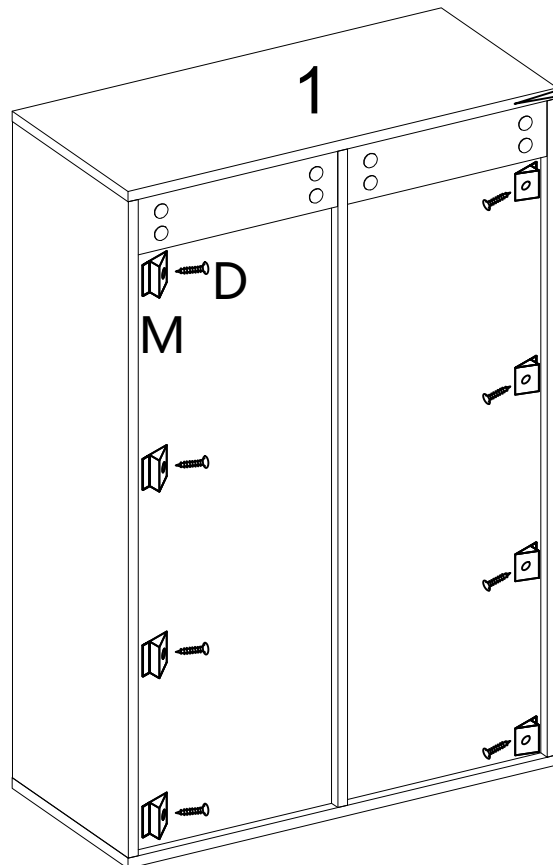

D X8	M X8	W X1

