

READ AND SAVE THIS INSTRUCTIONS FOR FUTURE USE

# ASSEMBLY & INSTRUCTION MANUAL

PACKING DETAILS: TOTAL 1 BOX

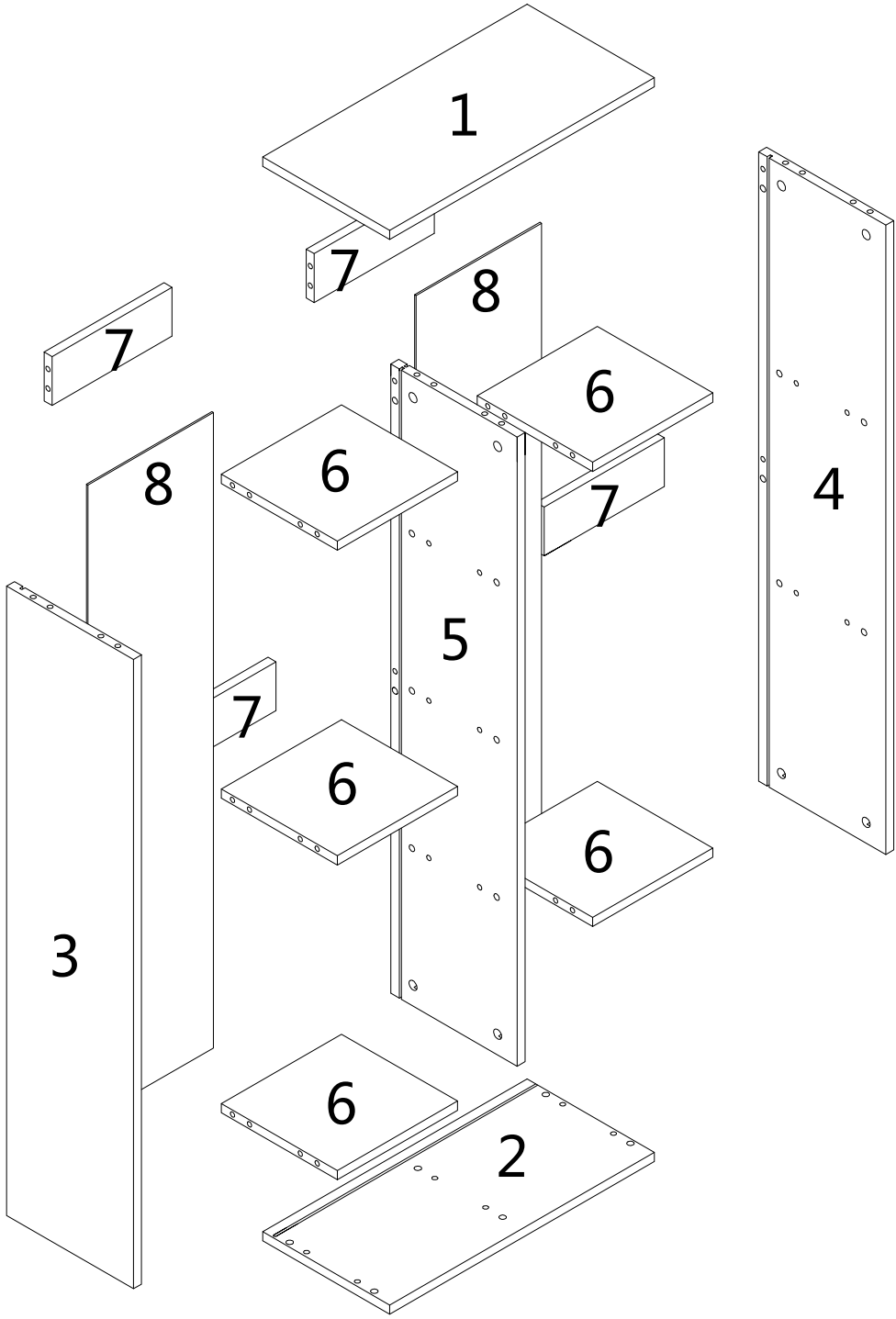

**A**

X40

**B** M8\*30

X36

**C** M8\*50

X2

**D** M3.5\*14

X8

**M**

X8

**T**

X40

**W**

X1

1

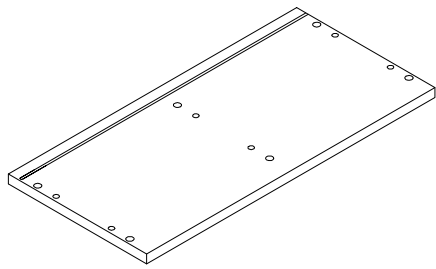

500\*240mm

2

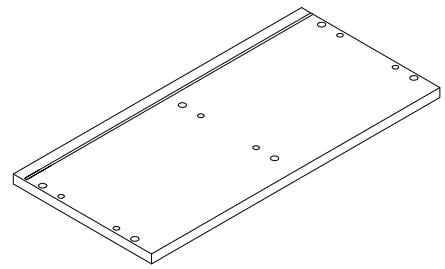

500\*240mm

3

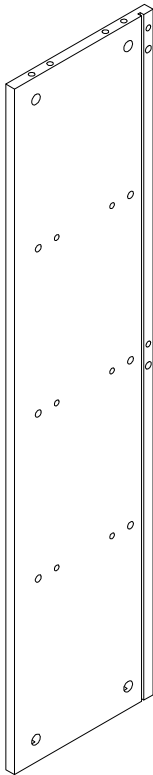

1030\*240mm

4

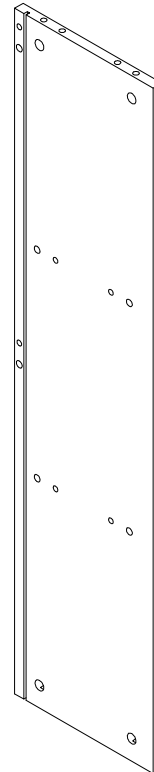

1030\*240mm

5

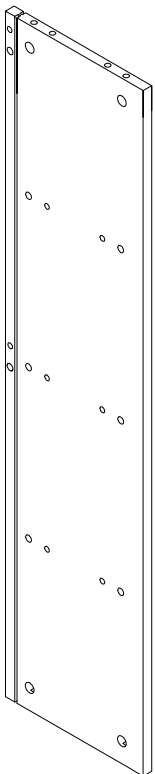

one side

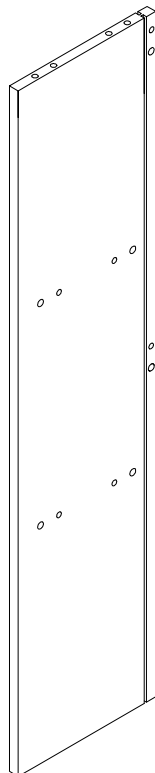

other side

1030\*239mm

6

X5

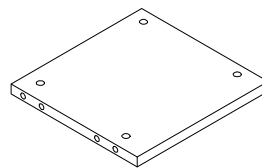

227\*218mm

8

X2

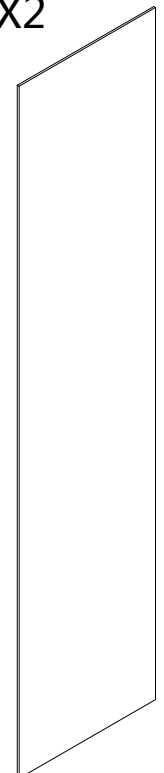

1040\*236mm

7

X4

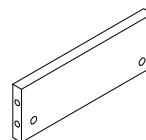

227\*80mm

1

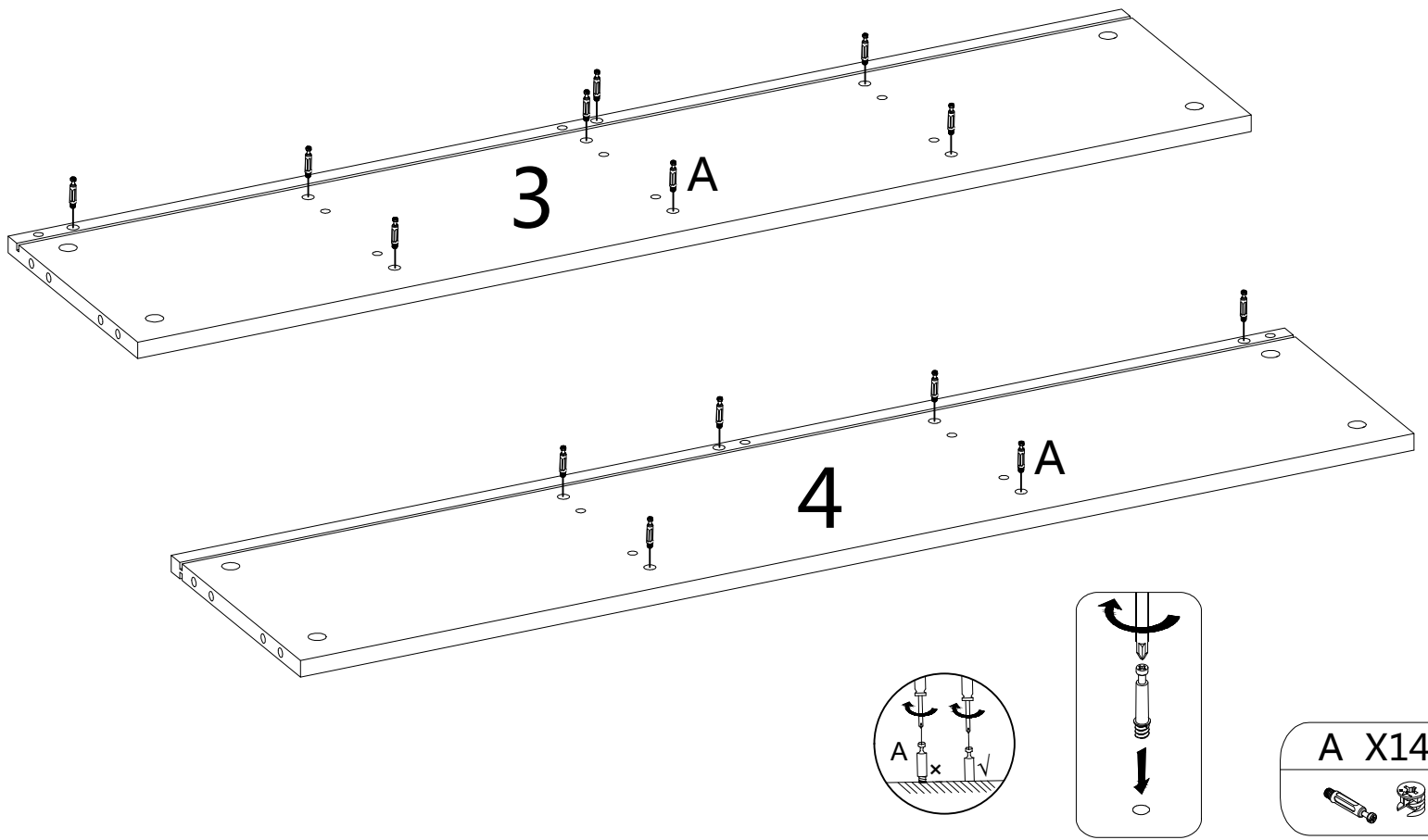

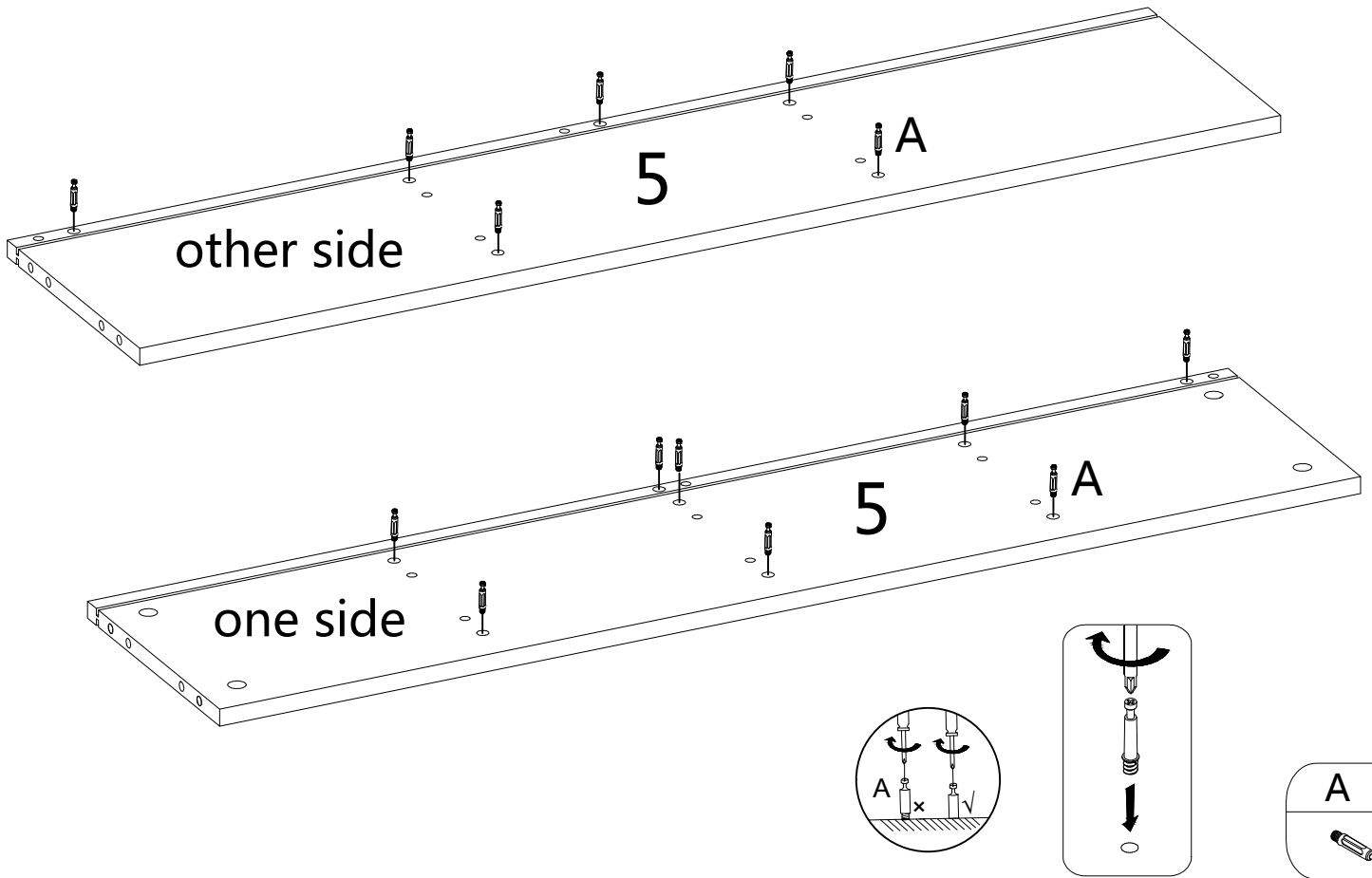

2



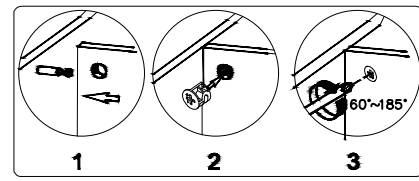
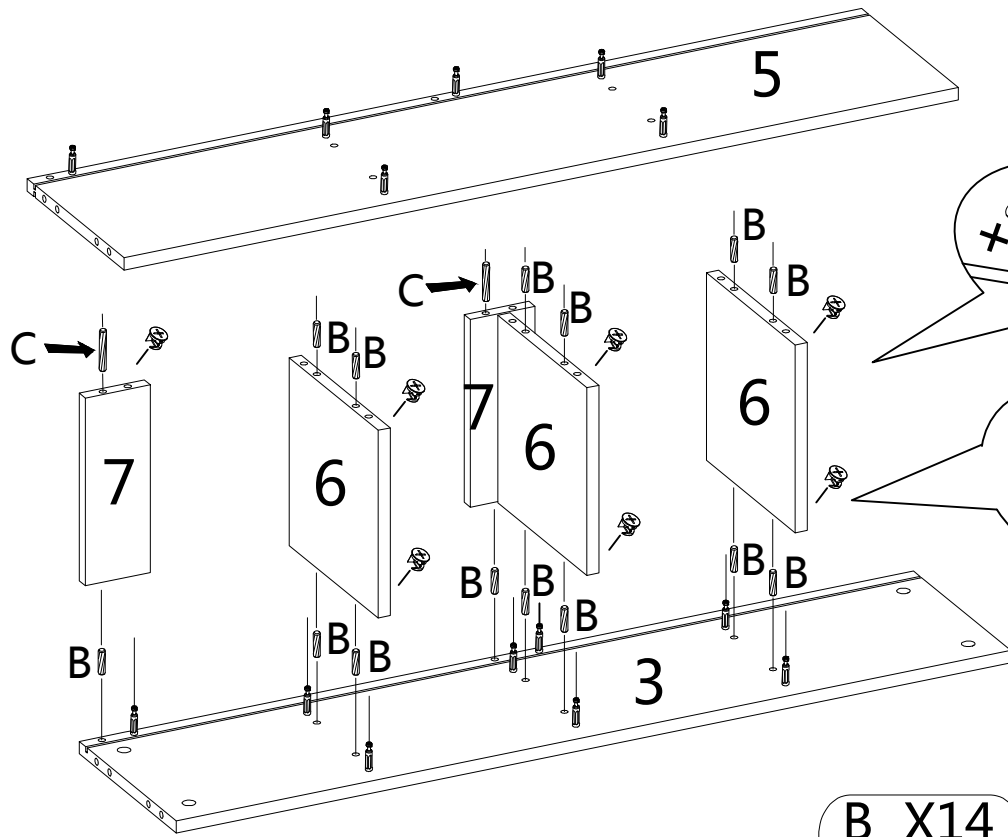

3

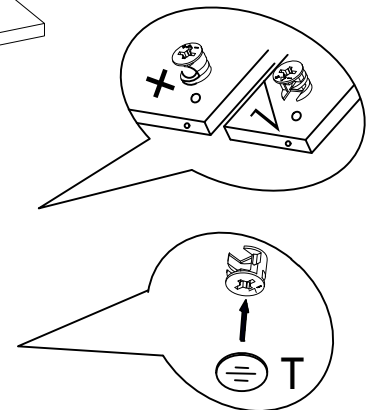
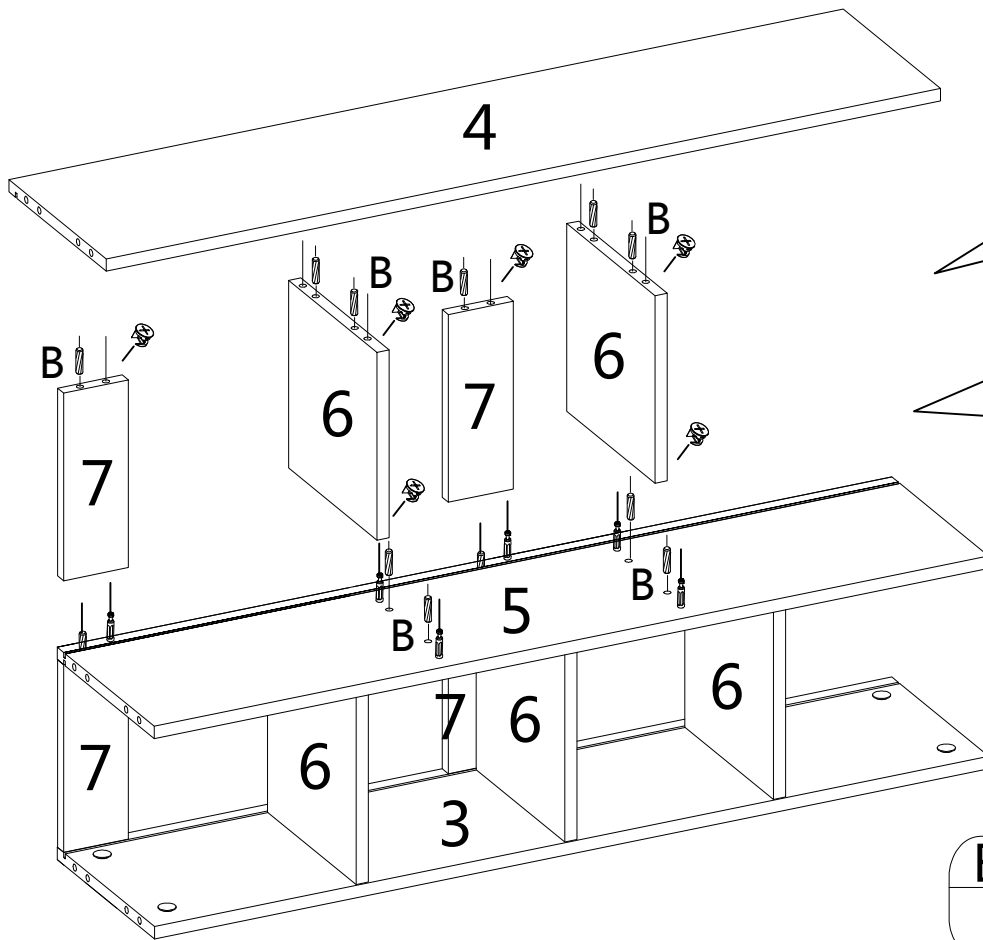

B X14	C X2	T X16
		

4



B X10	T X12
	

5

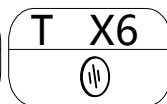
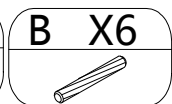
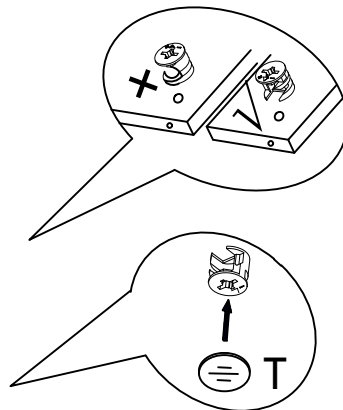
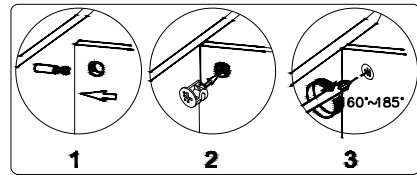
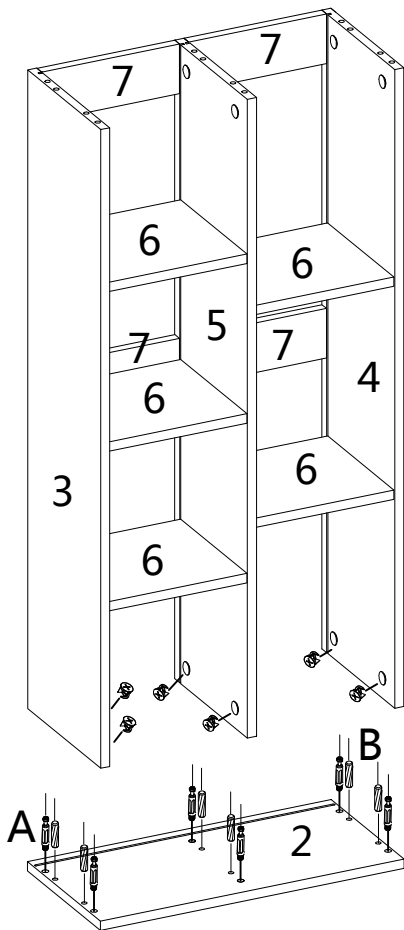
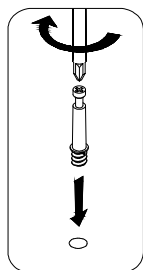
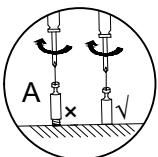

6

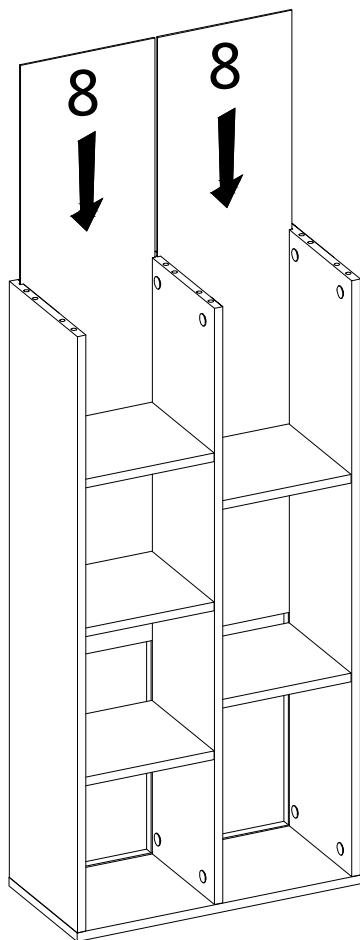

7

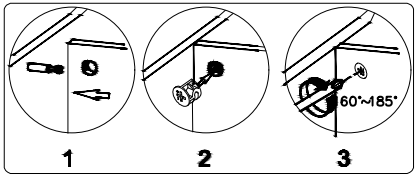
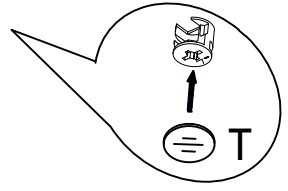
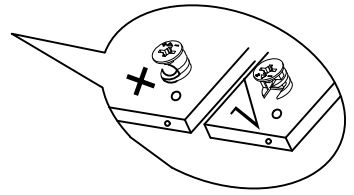
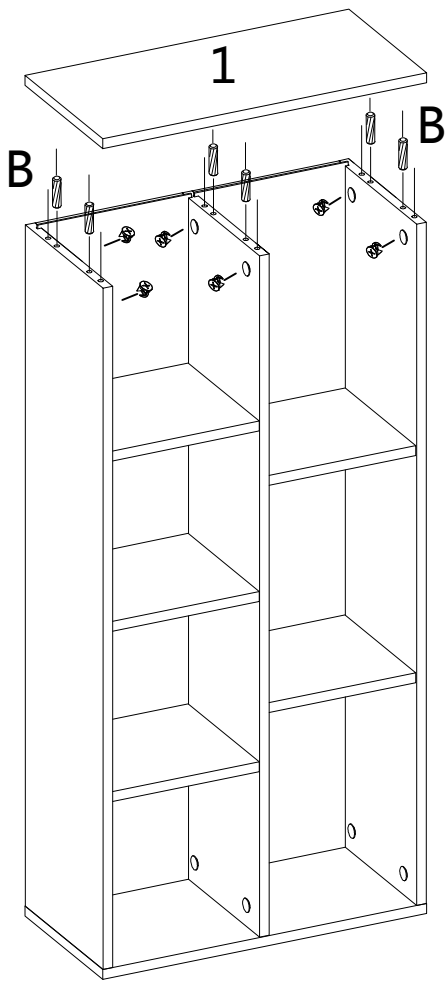
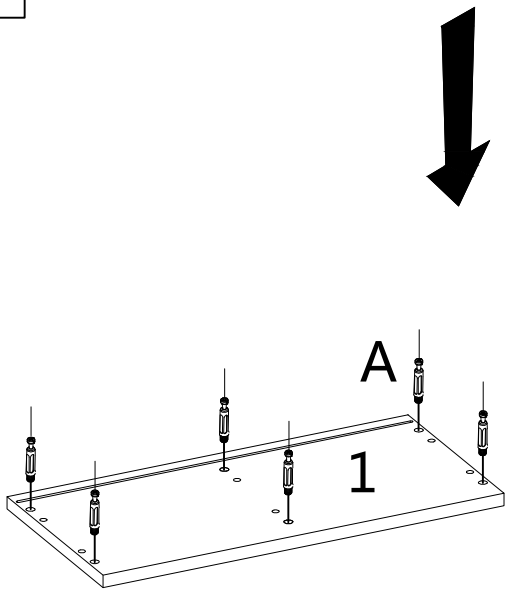

<b>A X6</b>	<b>B X6</b>	<b>T X6</b>

8

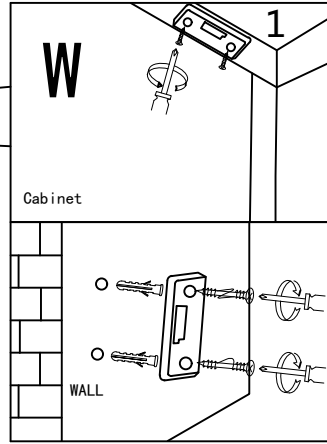
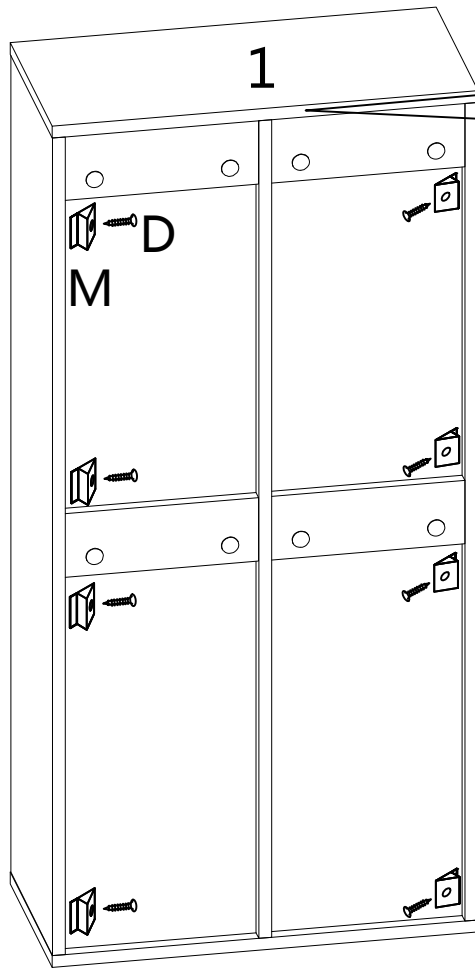

<b>D X8</b>	<b>M X8</b>	<b>W X1</b>

