

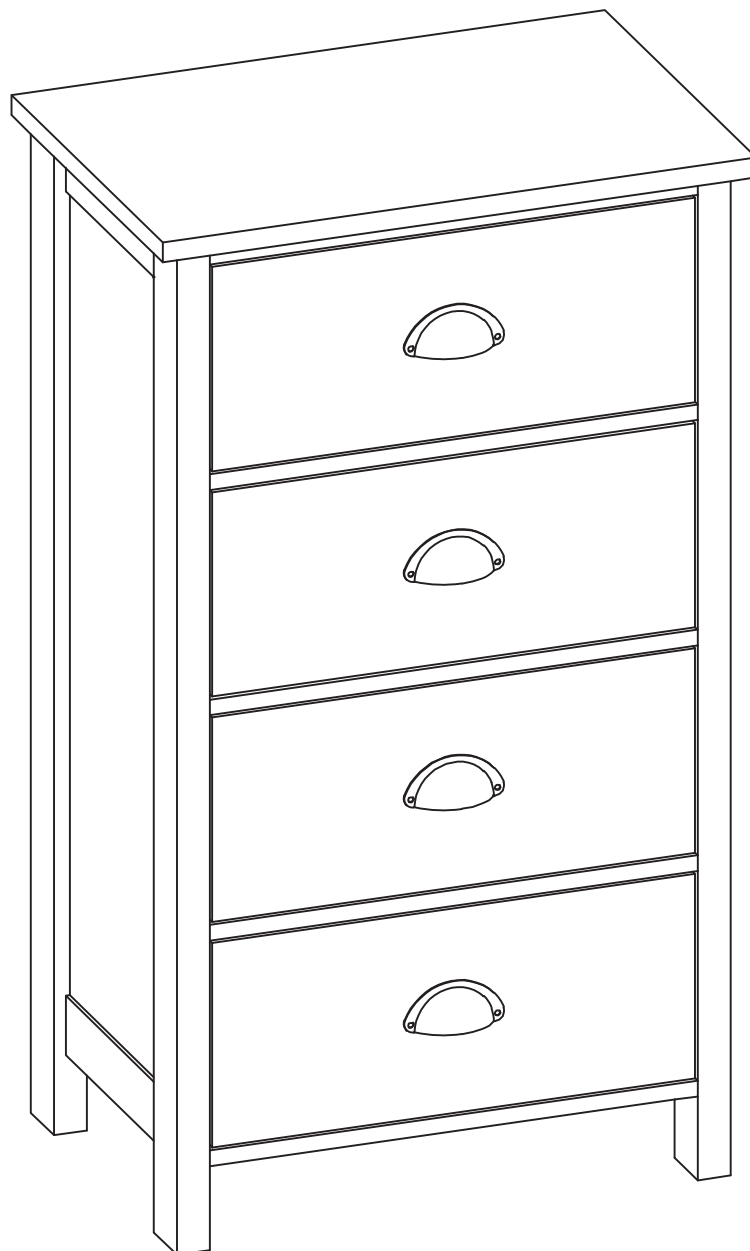

INcre044_GL

831-449



IMPORTANT, RETAIN FOR FUTURE REFERENCE: READ CAREFULLY

ASSEMBLY & INSTRUCTION MANUAL

1 x 1

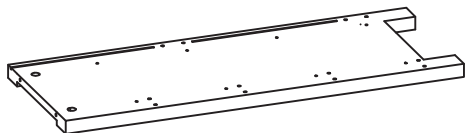

2 x 1

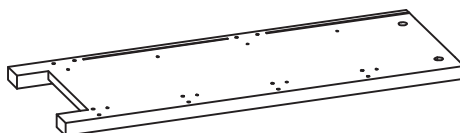

3 x 1



4 x 1

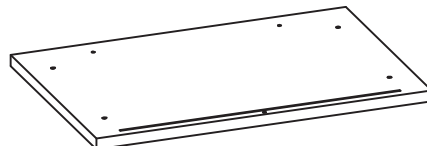

5 x 4



6 x 1



7 x 1



8 x 2

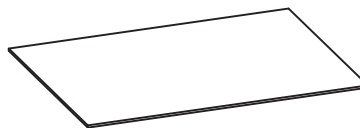

9 x 4



10 x 4



11 x 4



12 x 4



13 x 4



A x44

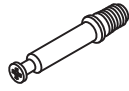

B x32



M3*12

C x 4

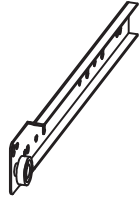

D x 4

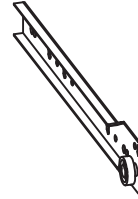

E x 2



F x 1



M4*20

G x 2



M2*12

H x 1



I x44



J x 4



K x 8



L x 4

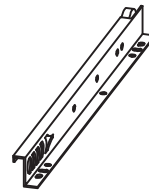

M3*12

M x 4

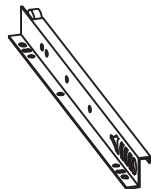

N x16

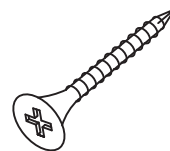

M4*30

O x 1

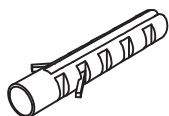

P x 1

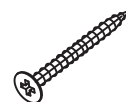

M4*45

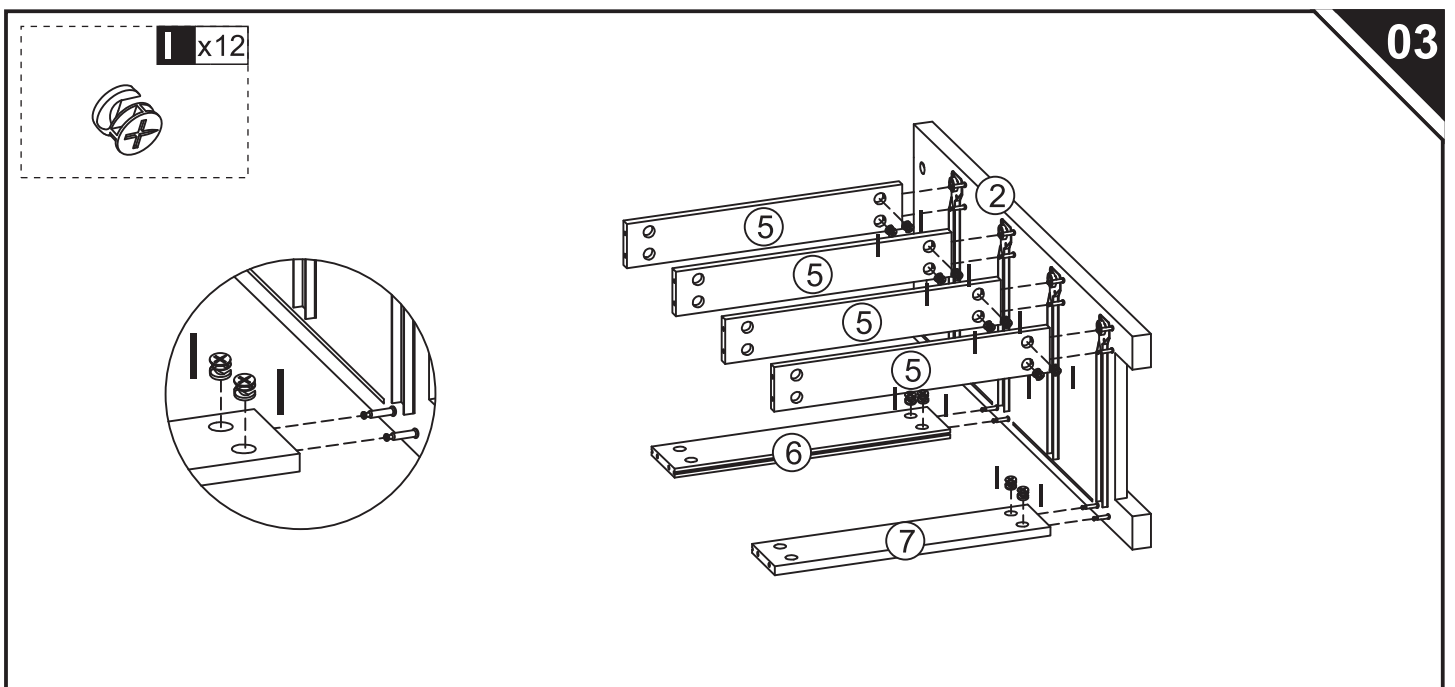
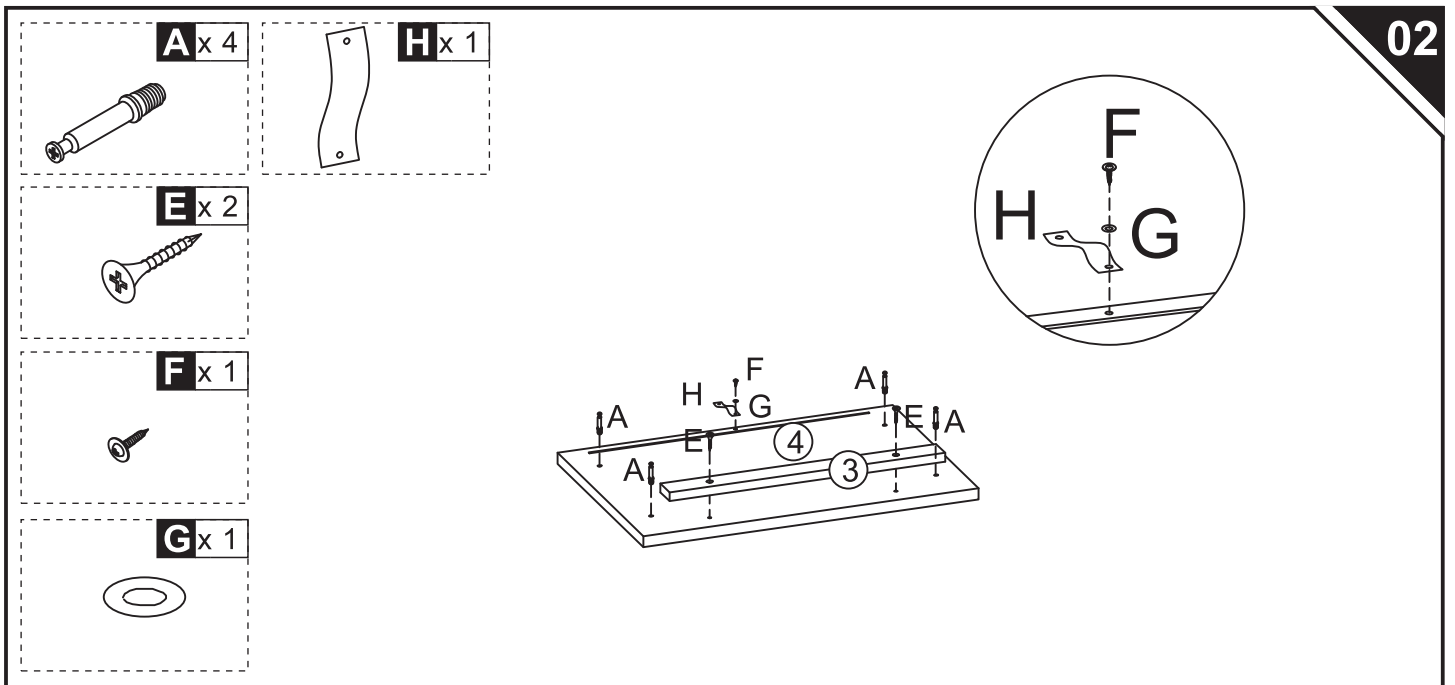
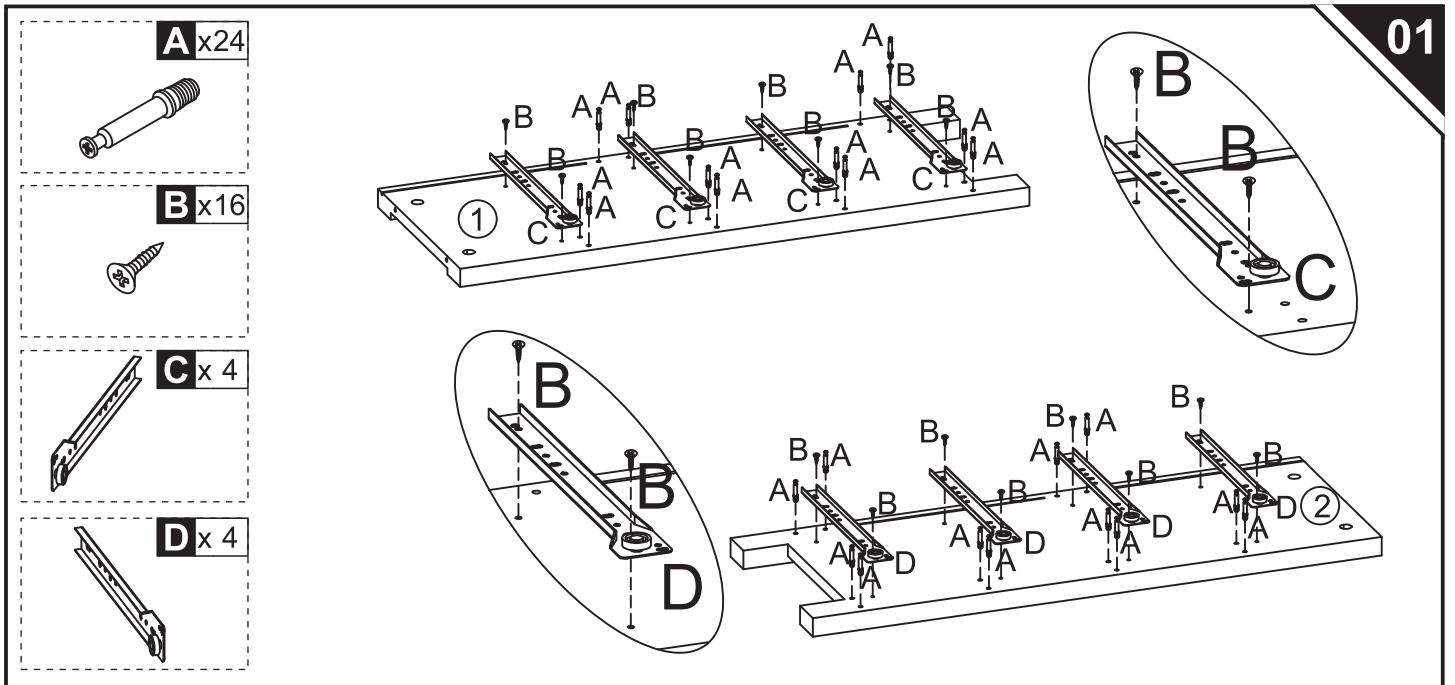

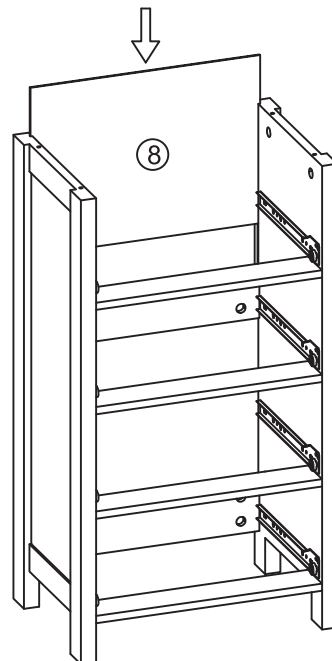
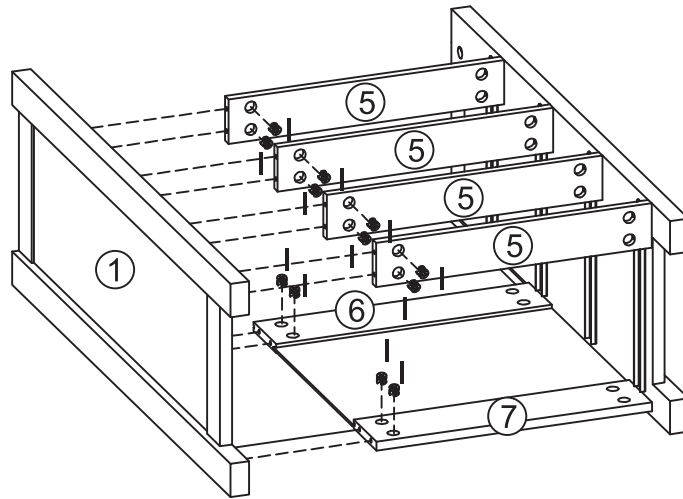
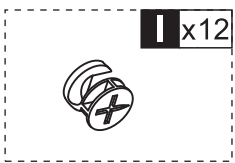
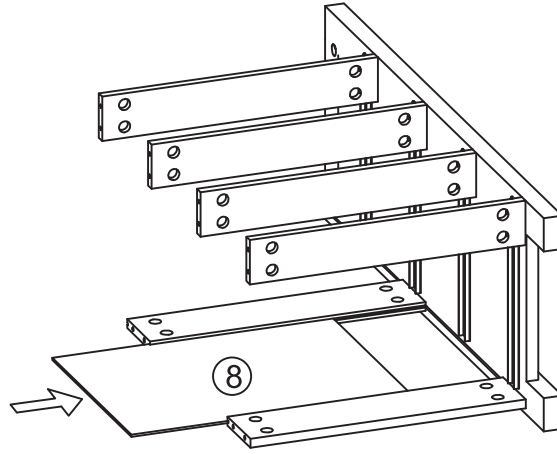

I x 4

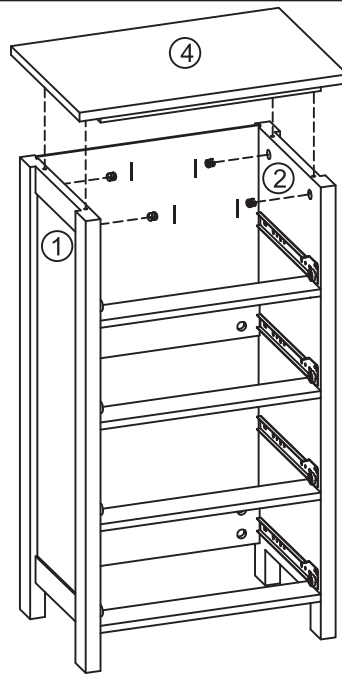

A x 16

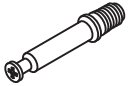

L x 4

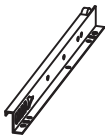

B x 16



M x 4



J x 4



K x 8

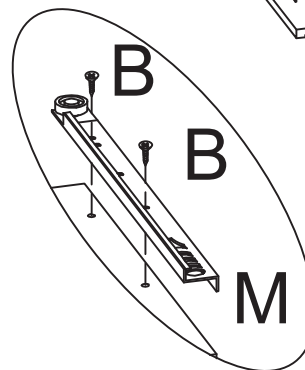
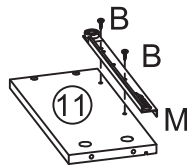
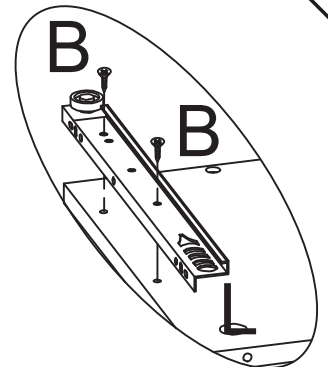
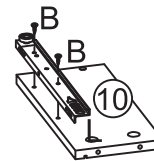
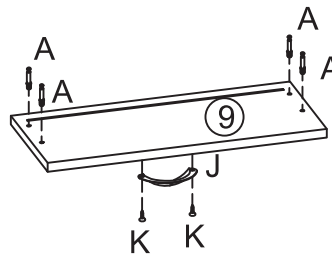

x4

I x 16



N x 16

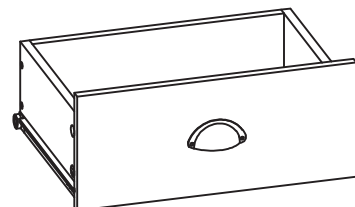
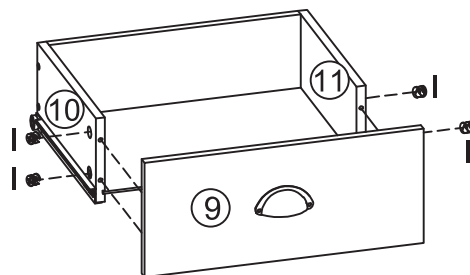
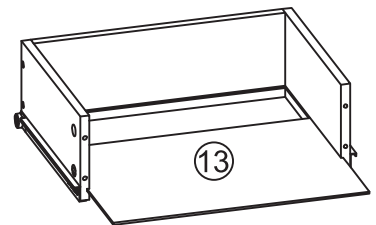
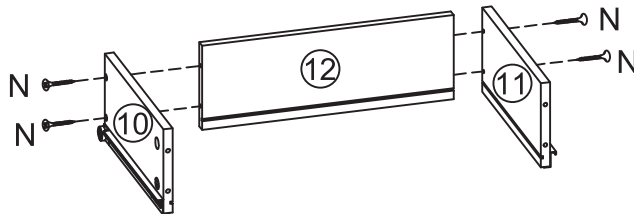

x4

