

kleanpin

INcve041_GL

834-371

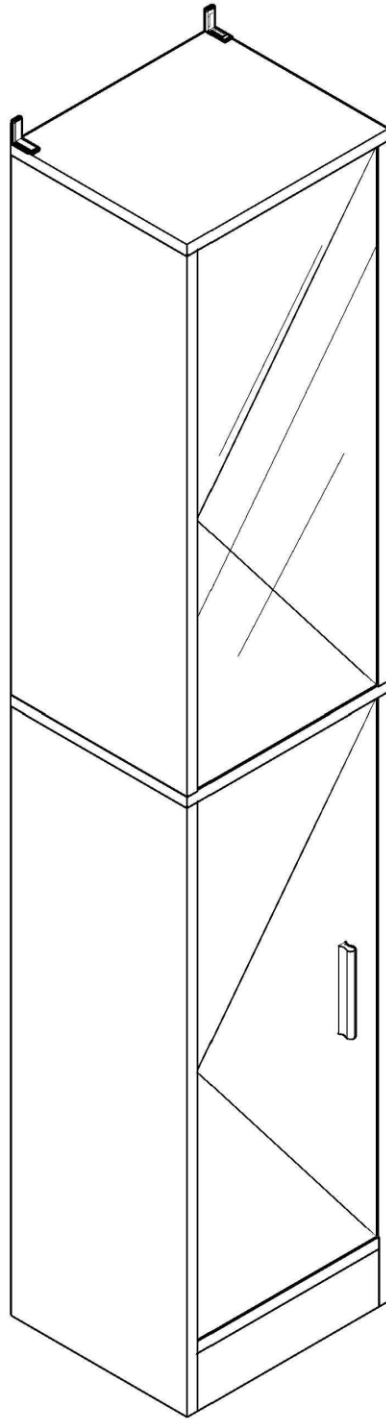

IMPORTANT, RETAIN FOR FUTURE REFERENCE: READ CAREFULLY

ASSEMBLY & INSTRUCTION MANUAL

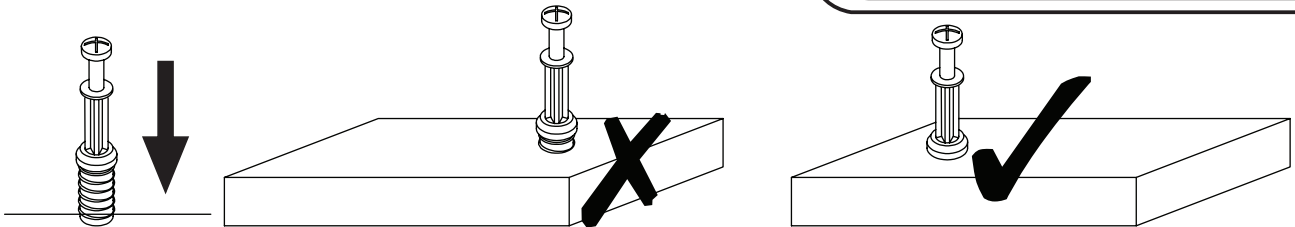

EN_QUICKFIT: Tighten quickfit until shoulder is flush with panel. Do not overtighten or undertighten.

FR_RACCORD RAPIDE: Faites serrer le raccord rapide jusqu'à ce que l'épaulement soit parfaitement encastré dans le panneau. Il ne faut ni trop serrer ni insuffisamment serrer.

ES_QUICKFIT: Apriete quickfit hasta que el hombro se descargue con el panel. NO lo sobreapriete ni lo apriete poco.

DE_QUICKFIT: Ziehen Sie den Quickfit fest, bis die Schulter mit der Platte bündig ist. Bitte nicht zu fest oder zu schwach anziehen.

IT_MONTAGGIO RAPIDO: Stringere il montaggio rapido fino a quando la spalla è a filo con il pannello, non stringere troppo o troppo poco.

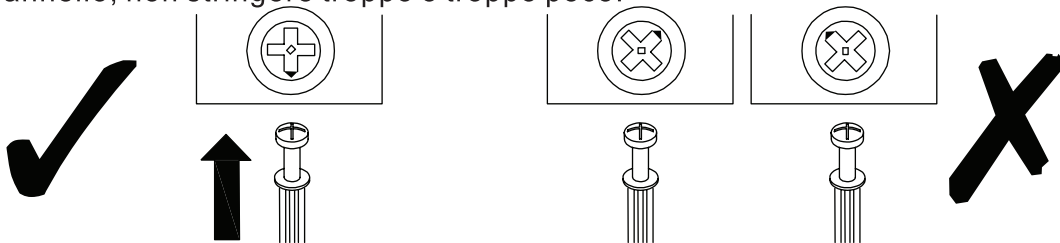

EN_CAM LOCK: When fitting cam lock, ensure starting position is correct before you insert connecting quickfit.

FR_SERRURE BATTEUSE: Avant d'insérer la serrure batteuse, veillez à la bonne orientation avant d'insérer le raccord rapide.

ES_CIERRE DE LA CÁMARA: Cuando instale el cierre de la cámara, asegúrese de que la posición de inicio es correcta antes de que inserte el quickfit conector.

DE_CAM-LOCK: Achten Sie bei der Montage des Cam-Locks auf die richtige Ausgangsposition, bevor Sie den Quickfit einsetzen.

IT_BLOCCAGGIO A CAMMA: Quando si monta il bloccaggio a camma, assicurarsi che la posizione iniziale sia corretta prima di inserire il montaggio rapido di collegamento.

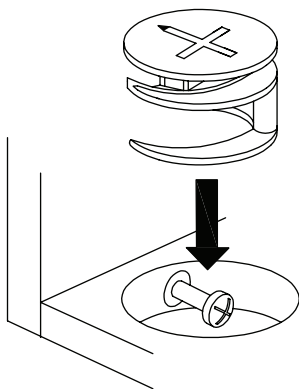

EN_Quickfit head should be in the centre of the cam lock when the two panels are joined.

Cam lock should be inserted before quickfit.

FR_Lorsque les deux panneaux sont assemblés, la tête du raccord rapide doit reposer au centre de la serrure batteuse.

Il faut insérer la serrure batteuse avant le raccord rapide.

ES_El cabezal del quickfit debe estar en el centro del cierre de la cámara cuando se unan los dos paneles.

Se debe insertar el cierre de la cámara antes que el quickfit.

DE_Der Quickfit-Kopf sollte sich in der Mitte des Cam-Locks befinden, wenn die beiden Platten zusammengefügt sind.

Der Cam-Lock sollte vor dem Quickfit eingesetzt werden.

IT_La testa del montaggio rapido deve trovarsi al centro del bloccaggio a camma quando i due pannelli sono uniti.

Il Bloccaggio a Camma deve essere inserito prima del montaggio rapido.

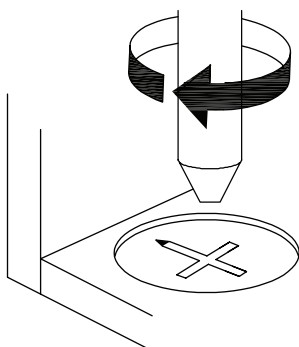

EN_Turn cam lock clockwise to tighten.

FR_Faites tourner la serrure batteuse dans le sens des aiguilles d'une montre pour la resserrer.

ES_Gire el cierre de la cámara en sentido horario para apretarlo.

DE_Drehen Sie den Cam-Lock im Uhrzeigersinn, um ihn festzuziehen.

IT_Ruotare il bloccaggio a camma in senso orario per stringere.

EN It may be necessary to adjust the hinges so that the doors align. Use the instructions below as a guide.

FR Il est parfois nécessaire d'ajuster les charnières pour un meilleur alignement des portes. Servez-vous des instructions ci-dessous comme guide.

ES Puede que sea necesario ajustar los quicios de forma que se alineen las puertas. Use las instrucciones que aparecen debajo como guía.

DE Möglicherweise müssen Sie die Scharniere so einstellen, dass die Türen ausgerichtet sind. Verwenden Sie die nachstehenden Anweisungen als Leitfaden.

IT Potrebbe essere necessario regolare le cerniere in modo che le porte siano allineate. Per fare ciò attenersi alle istruzioni sottostanti.

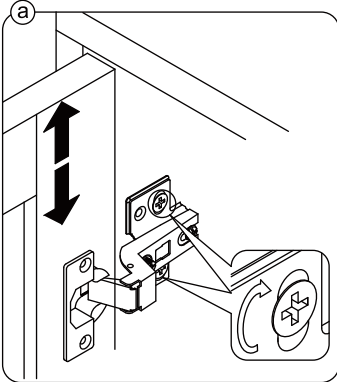

EN To adjust the door vertically loosen the screw as shown and move up and down as needed.

FR Si vous souhaitez régler la porte **verticalement**, desserrez la vis comme indiqué et déplacez la porte de haut en bas selon les besoins.

ES Para ajustar la puerta **verticalmente** afloje el tornillo tal y como se muestra y muévelo hacia arriba o hacia abajo según sea necesario.

DE Um die Tür **vertikal** auszurichten, lösen Sie die Schraube wie abgebildet und bewegen Sie sie nach Bedarf nach oben oder nach unten.

IT Per allineare la porta **verticalmente** allentare la vite come mostrato e spostarla in alto o in basso secondo necessità.

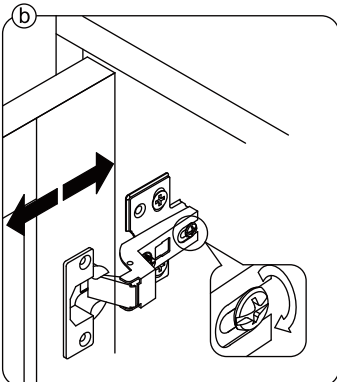

EN To adjust the gap from the door to the main frame turn the screw clockwise or anti-clockwise as needed.

FR Si vous souhaitez ajuster l'**écart** entre la porte et le cadre principal, tournez la vis dans le sens des aiguilles d'une montre ou dans le sens inverse, si nécessaire.

ES Para ajustar el **espacio** desde la puerta al marco principal, gire el tornillo en sentido horario o antihorario, según se necesite.

DE Um den **Abstand** von der Tür zum Hauptrahmen auszurichten, drehen Sie die Schraube je nach Bedarf im oder gegen den Uhrzeigersinn.

IT Per regolare lo **spazio** tra la porta e il telaio principale, avvitare o svitare la vite secondo necessità.

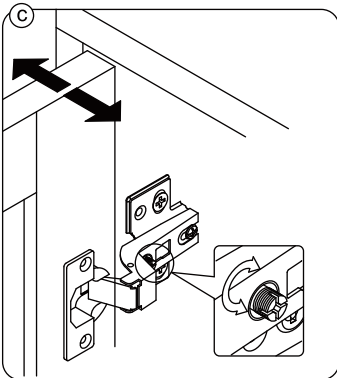

EN To adjust the door laterally adjust the screw as shown by turning clockwise or anti-clockwise.

FR Si vous souhaitez ajuster la porte **latéralement**, ajustez la vis comme indiqué en tournant dans le sens des aiguilles d'une montre ou dans le sens inverse des aiguilles d'une montre.

ES Para ajustar la puerta **lateralmente** ajuste el tornillo tal y como se muestra girándolo en sentido horario y antihorario.

DE Um die Tür **seitlich** auszurichten, stellen Sie bitte die Schraube wie abgebildet durch Drehen im oder gegen den Uhrzeigersinn ein.

IT Per allineare la porta **lateralmente** regolare la vite come mostrato, avvitandola o svitandola.

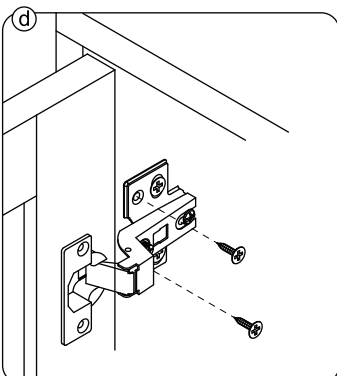









EN Please fix other screws

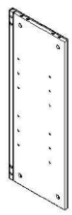

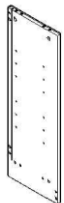
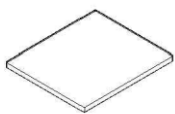
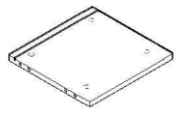
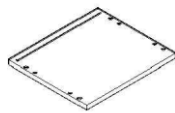

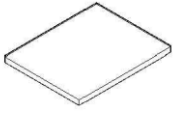
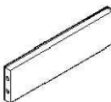

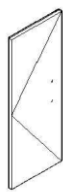
FR Merci de serrer les autres vis.

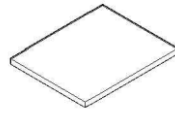
ES Fije los demás tornillos

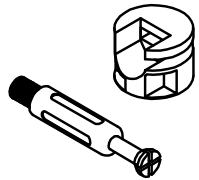
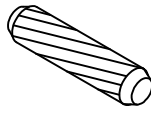
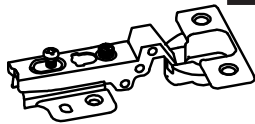
DE Befestigen Sie bitte die anderen Schrauben

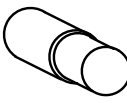
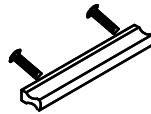
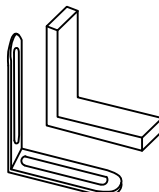
IT Fissare le altre viti

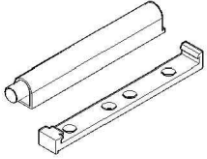
| | | |
|--|--|--|
|  <p>1 x01</p> |  <p>2 x01</p> |  <p>3 x01</p> |
|  <p>4 x01</p> |  <p>5 x01</p> |  <p>6 x01</p> |
|  <p>7 x01</p> |  <p>8 x04</p> |  <p>9 x02</p> |
|  <p>10 x01</p> |  <p>11 x01</p> |  <p>12 x01</p> |
|  <p>13 x02</p> | |  <p>14 x02</p> |

| | | |
|---|---|---|
|  <p>A x26 +2(spare)</p> |  <p>B x26 M8*30 +2(spare)</p> |  <p>C x04</p> |
|  <p>D x18 M3.5*14 +2(spare)</p> |  <p>E x16</p> |  <p>F x01</p> |
|  <p>G x02</p> |  <p>H x02</p> |  <p>I x26 +2(spare)</p> |
|  <p>J x01</p> | |  <p>K x02 M4*25</p> |

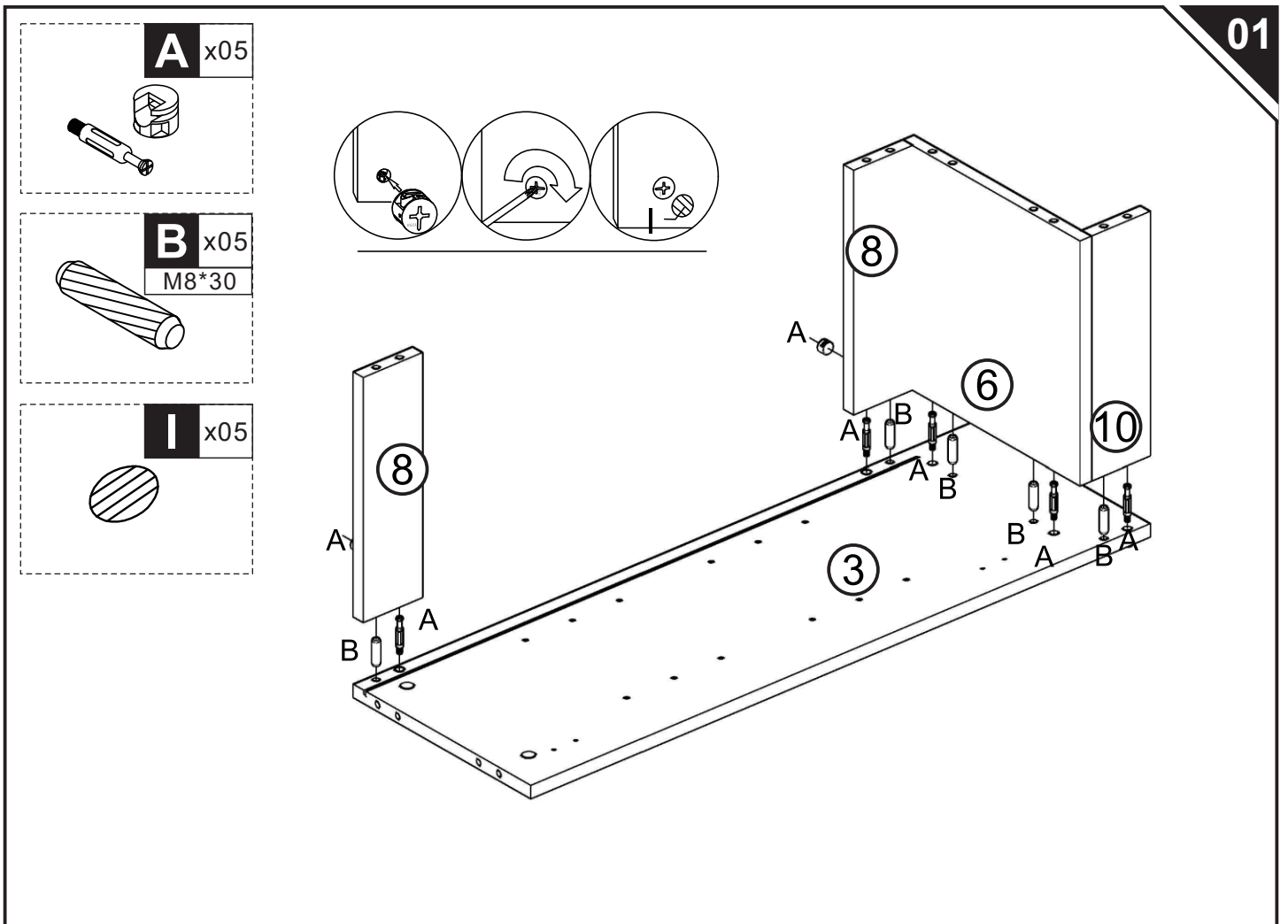

A x05

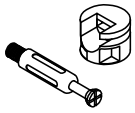

B x05
M8*30



I x05

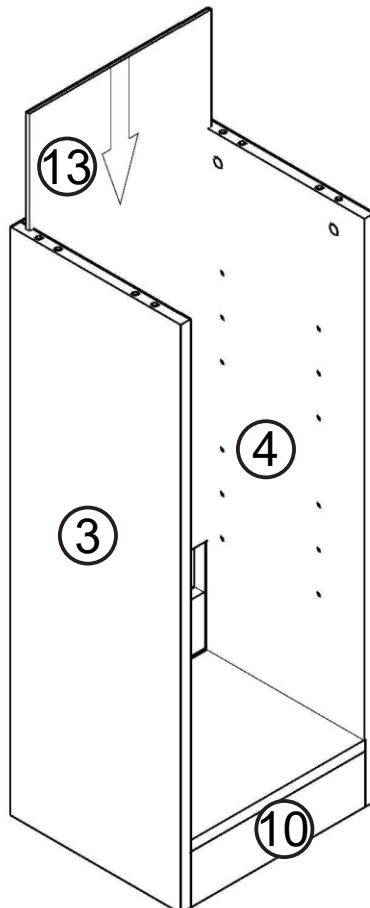
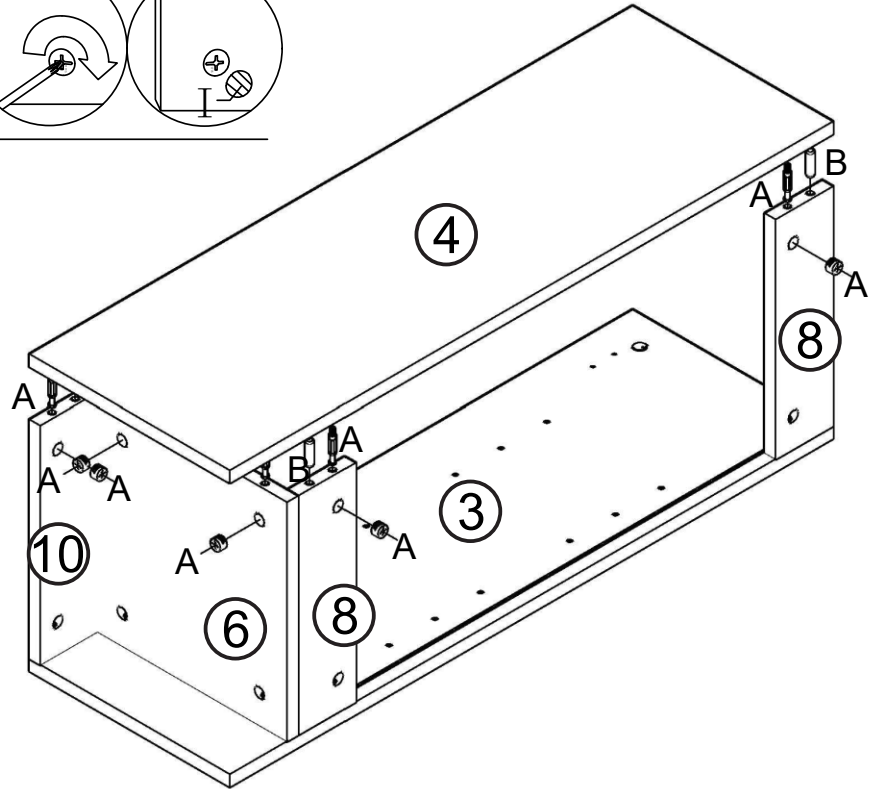
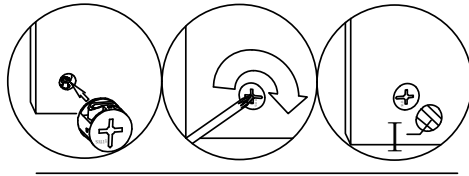

A x04

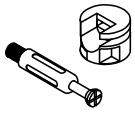

B x04
M8*30



I x04

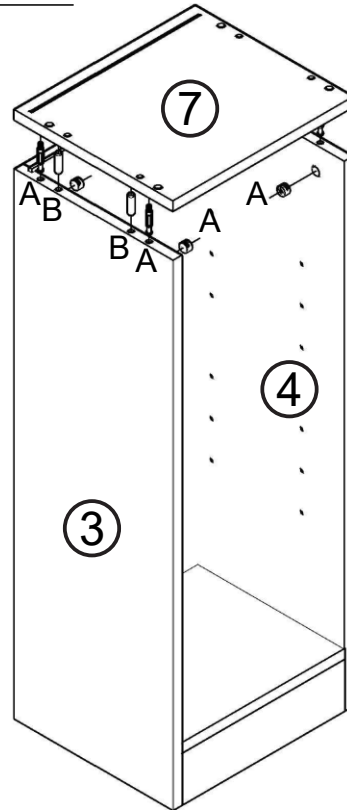
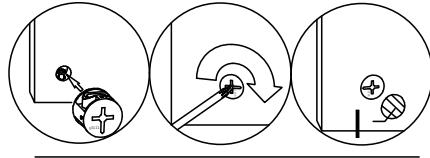

A x04

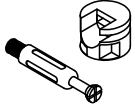

B x04
M8*30



I x04

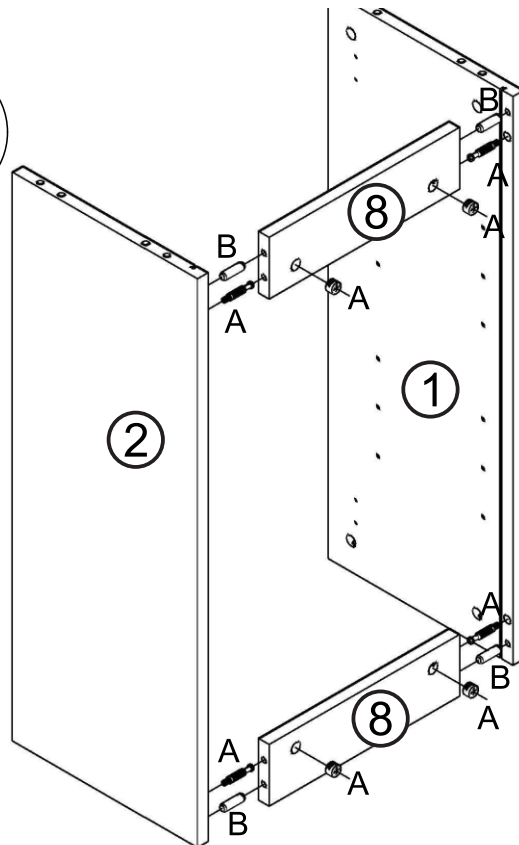
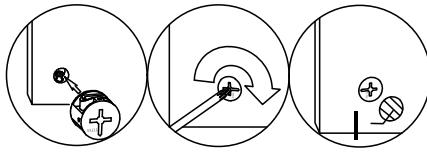

A x04

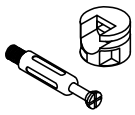

B x04
M8*30



I x04

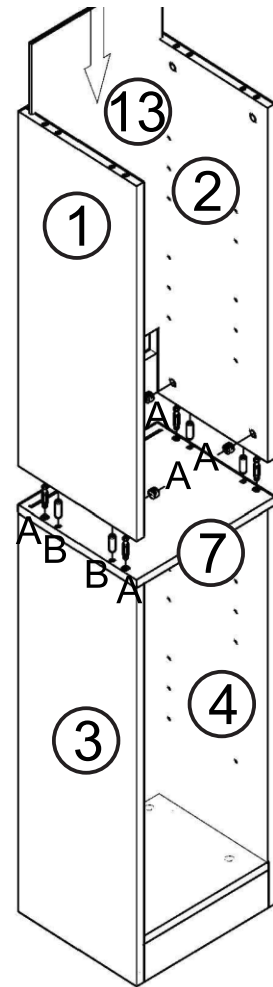
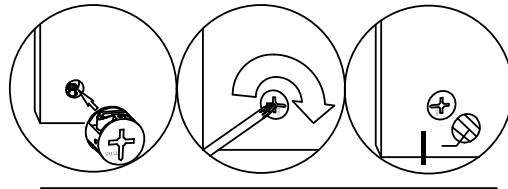

A x04

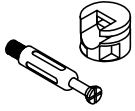

B x04
M8*30



I x04

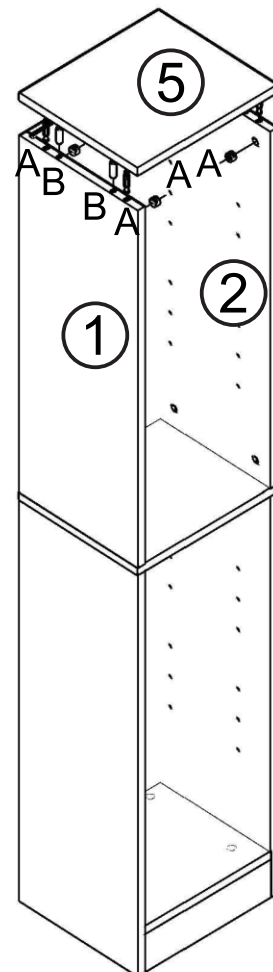
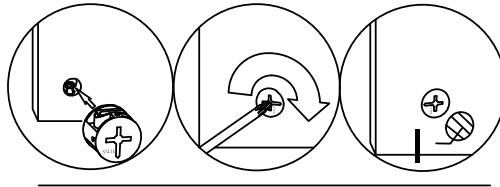

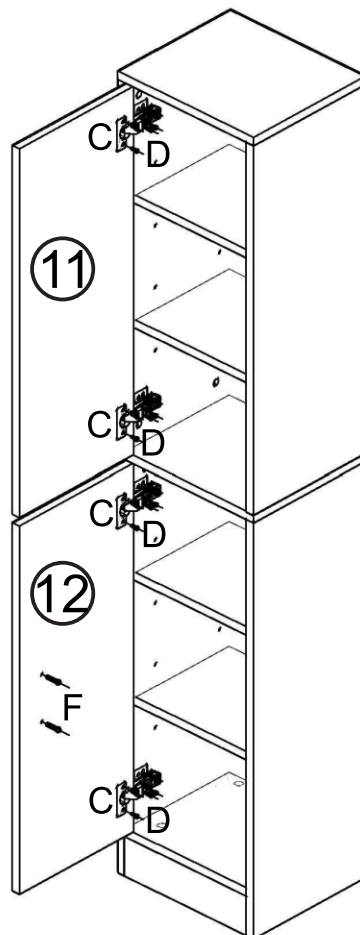
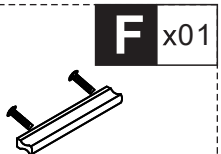
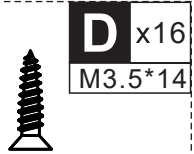
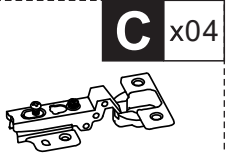
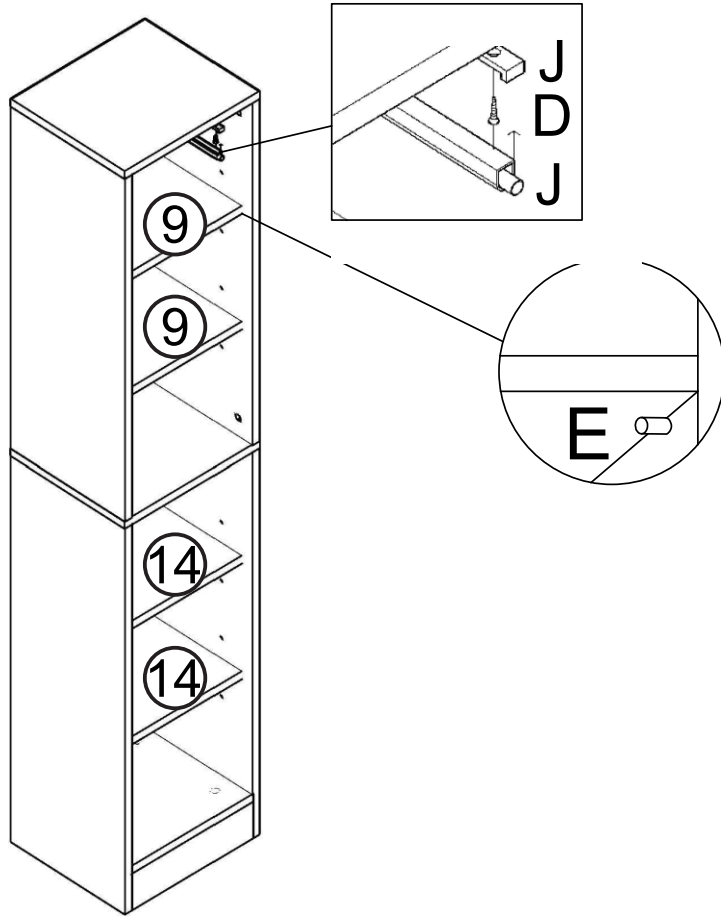
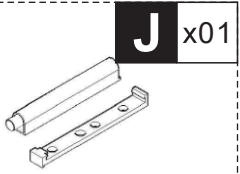

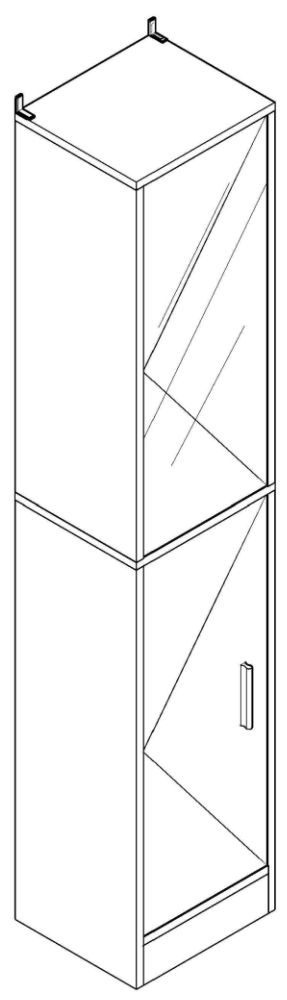
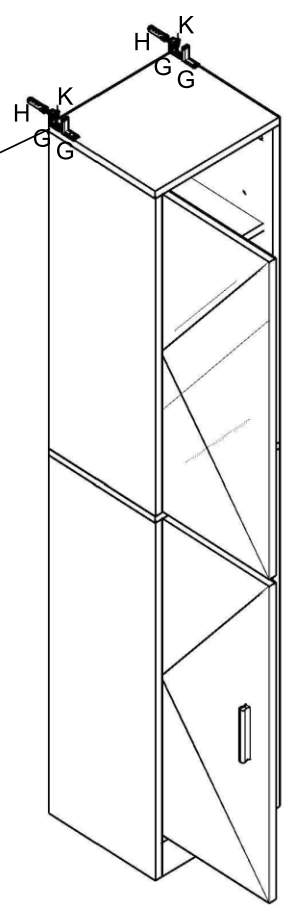
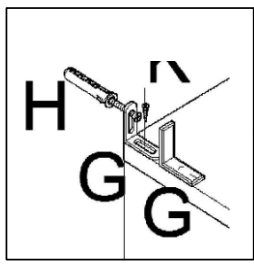
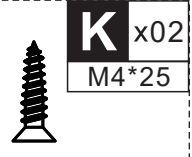
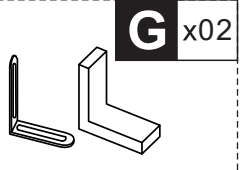

IMPORTER**EN**

MH STAR UK LTD
Unit 27, Perivale Park, Horsenden lane South
Perivale, UB6 7RH
<https://www.aosom.co.uk>
Made in China

IMPORTATEUR**FR**

MH FRANCE
2 Rue Maurice Hartmann 92130 Issy Les Moulineaux
France
<https://www.aosom.fr>
Fabriqué en Chine

IMPORTADOR POR**ES**

Spanish Aosom, S.L.
C. roc gros no.15. 08550, Els Hostalets de Balenyà, Spain. B66295775
TEL: 931294512
www.aosom.es
atencioncliente@aosom.es
Fabricado en China

IMPORTEUR**DE**

MH Handel GmbH
Wendenstraße 309 D-20537 Hamburg
Germany
<https://www.aosom.de>
Hergestellt in China

IMPORTATO DA**IT**

AOSOM Italy srl
Centro Direzionale Milanofiori Strada 1 Palazzo F1 20057 Assago (MI)
P.I.: 08567220960
<https://www.aosom.it>
Prodotto in Cina