

PawHut

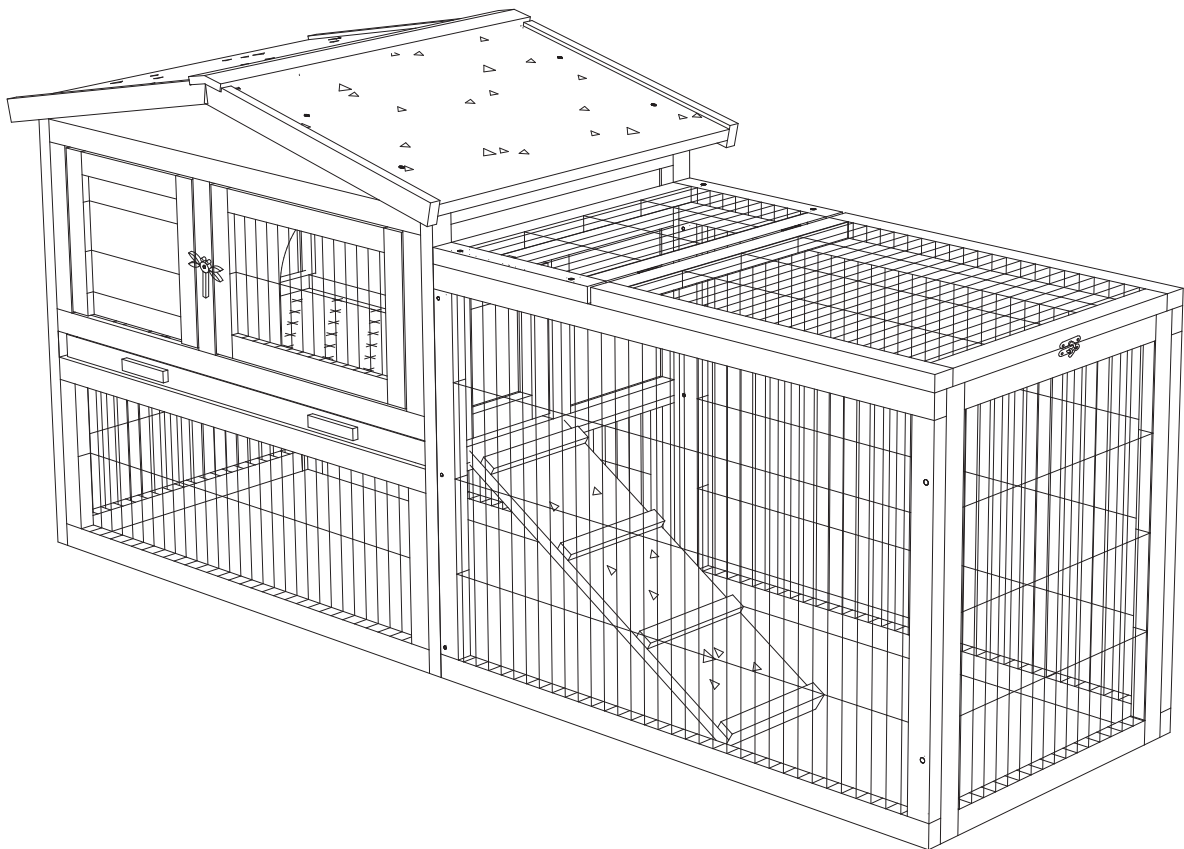



INdcd057V03_GL

D51-122

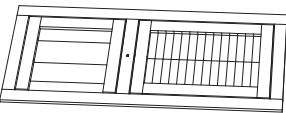

READ AND SAVE THIS INSTRUCTIONS FOR FUTURE USE

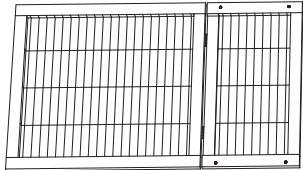
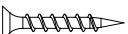
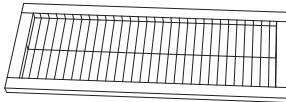
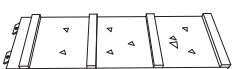
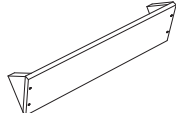
ASSEMBLY & INSTRUCTION MANUAL

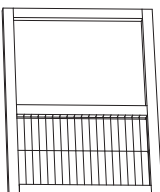
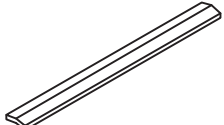
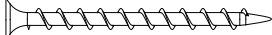
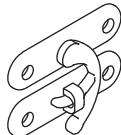
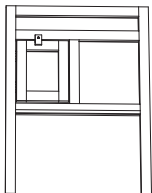
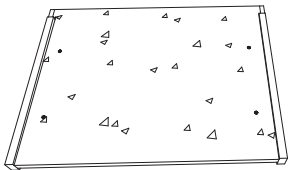
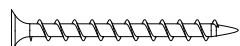
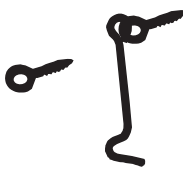
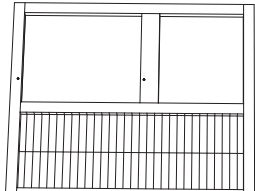
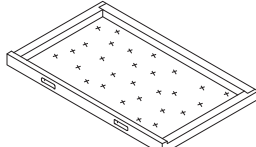
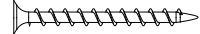
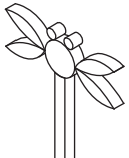
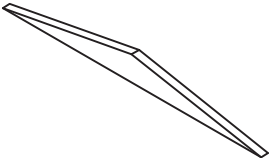
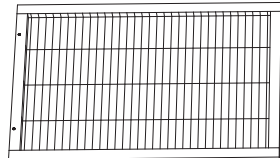
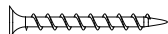
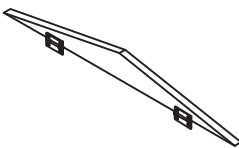
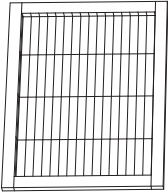
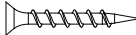
<p>1 x01</p> 	<p>8 x01</p> 	<p>15 x01</p> 	<p>F x10+1(spare)</p> 
<p>2 x01</p> 	<p>9 x01</p> 	<p>16 x01</p> 	<p>M3.0*16</p> <p>G x04</p> 
<p>3 x01</p> 	<p>10 x01</p> 	<p>A x04</p> 	<p>H x01</p> 
<p>4 x01</p> 	<p>11 x02</p> 	<p>M3.5*25</p> <p>B x24+2 (spare)</p> 	<p>I x01</p> 
<p>5 x01</p> 	<p>12 x01</p> 	<p>M3.5*40</p> <p>C x08+1(spare)</p> 	<p>J x01</p> 
<p>6 x01</p> 	<p>13 x02</p> 	<p>D x01</p> 	<p>M3.5*30</p>
<p>7 x01</p> 	<p>14 x01</p> 	<p>E x04</p> 	<p>M3.0*25</p>

①x01

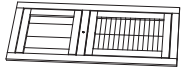

Gx04



Jx01



Dx01

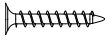

M3.0*25

1



G



G



Gx4

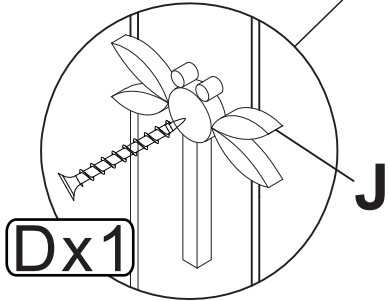

②x01



③x01



④x01



Bx08

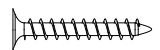

M3.5*40

3

4

B

B

B

B

B

B

B

B

Bx8

2

5 x01

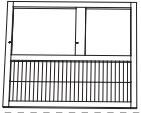

16 x01



B x08

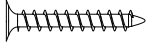

M3.5*40

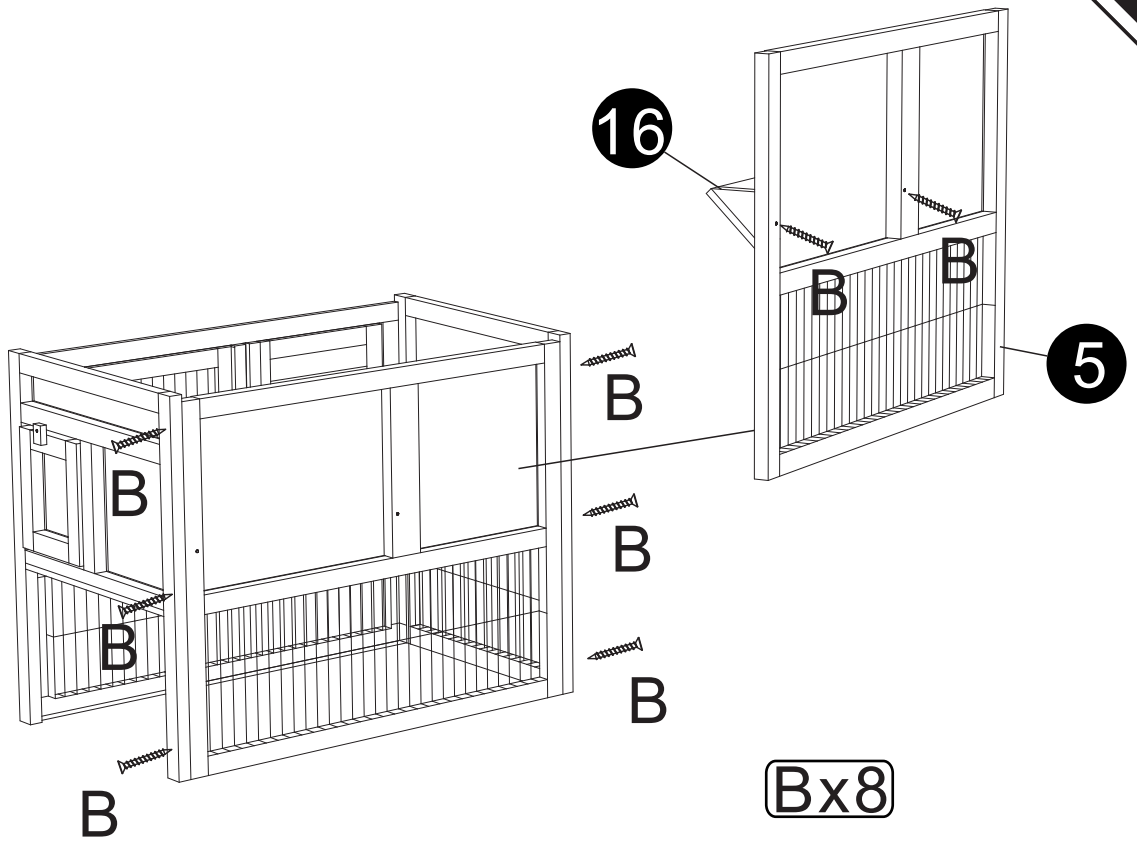

8 x01

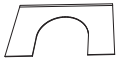

12 x01

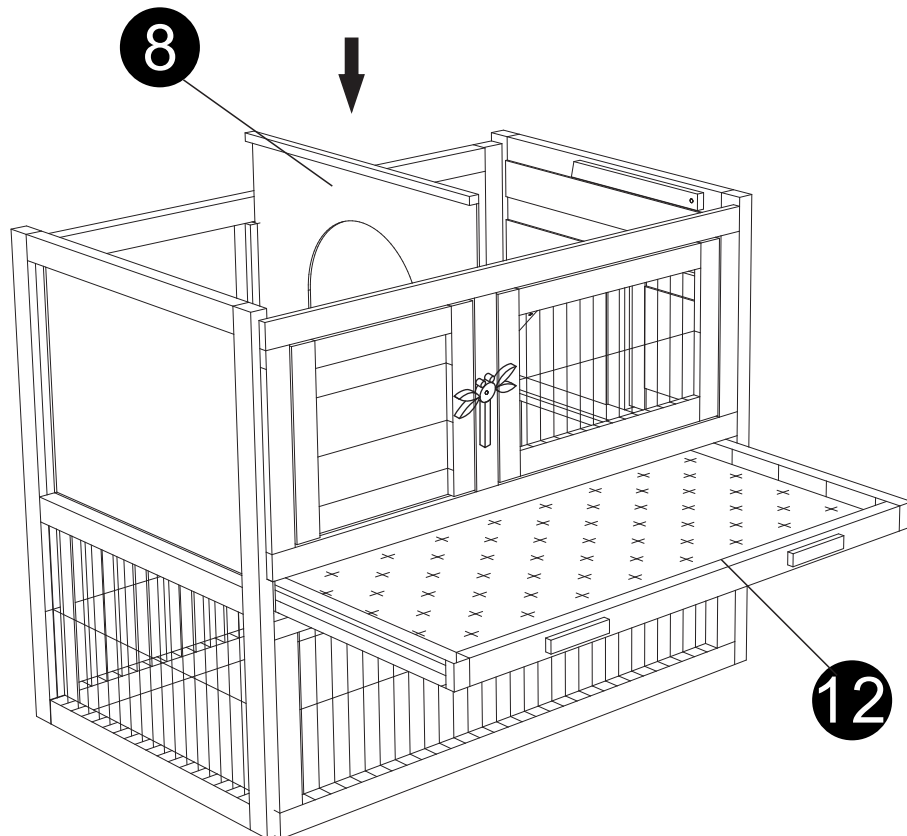
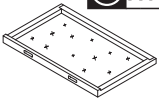

9 x01

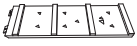

F x02

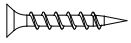

M3.0*16

F x2

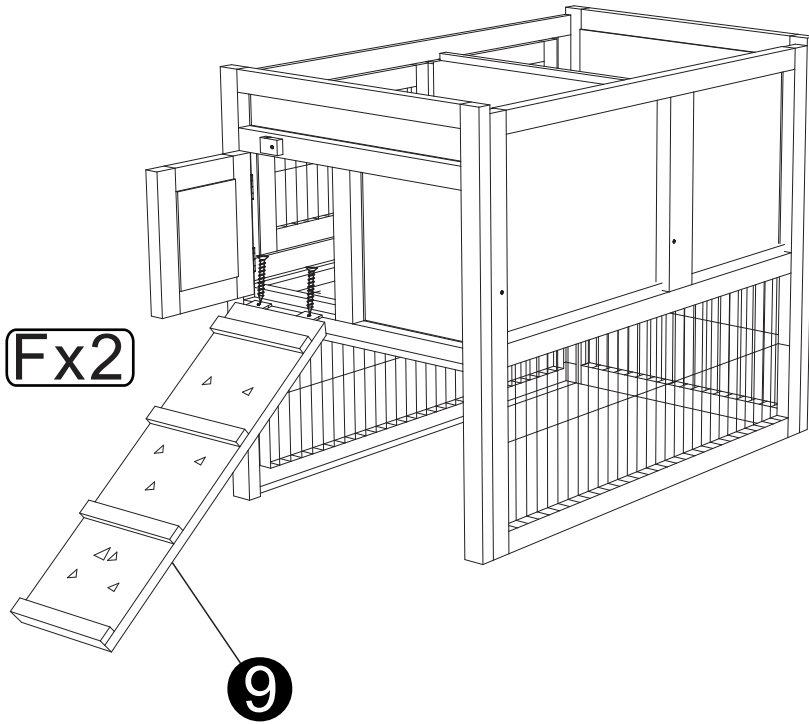

9

6 x01

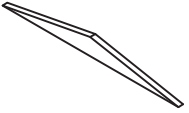

7 x01

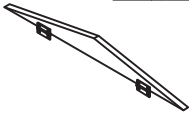

10 x01

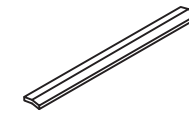

11 x02

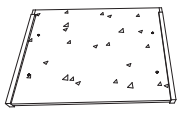

C x08

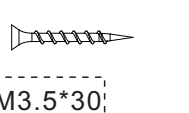

M3.5*30

E x04

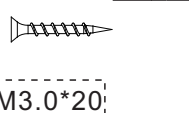

M3.0*20

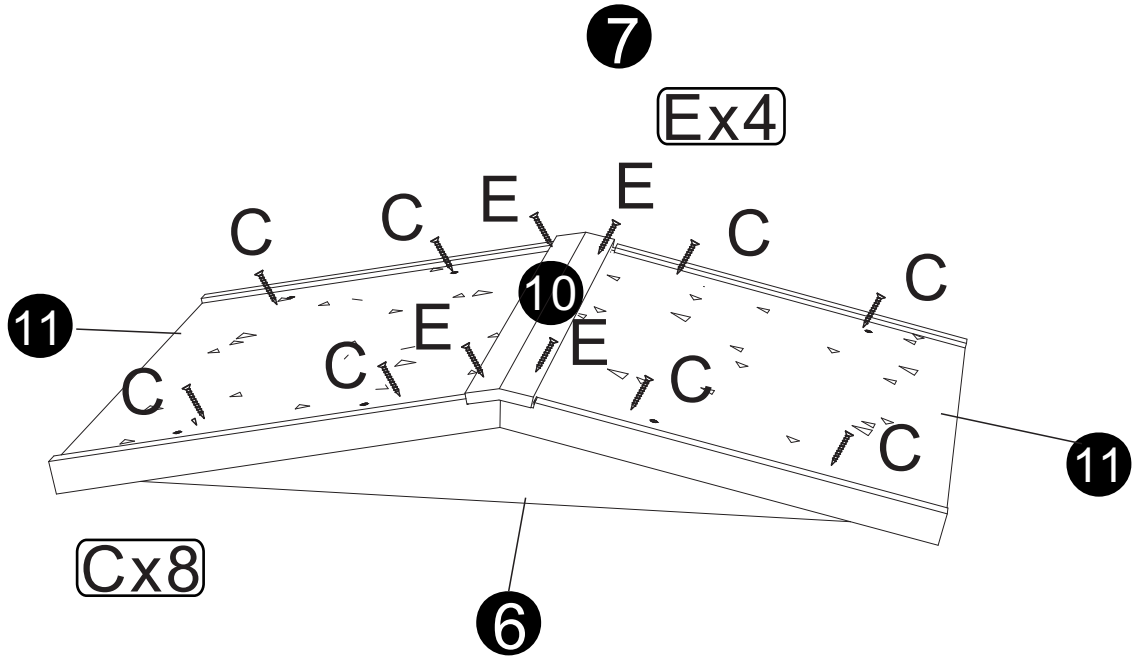

7

Ex4

11

10

11

Cx8

6

F x04

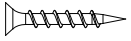

M3.0*16

I x01



F x4

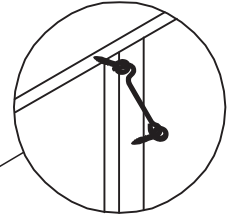
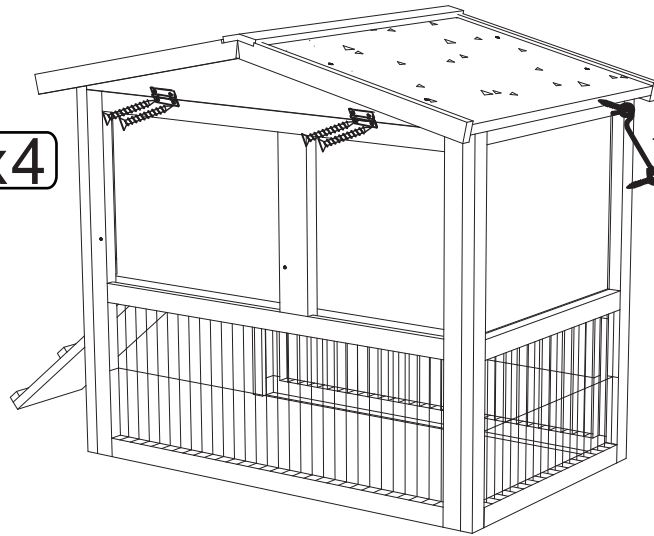

13 x02

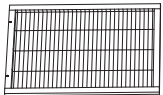

14 x01



15 x01



B x08

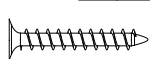

M3.5*40

F x04

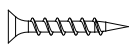

M3.0*16

H x01



13

14

15

13

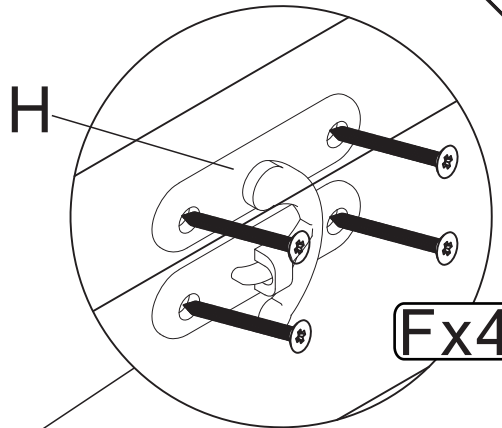
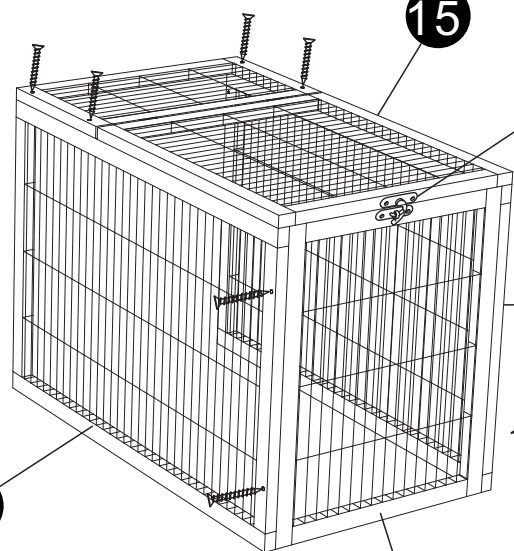

F x4

A x04

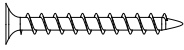

M3.5*25

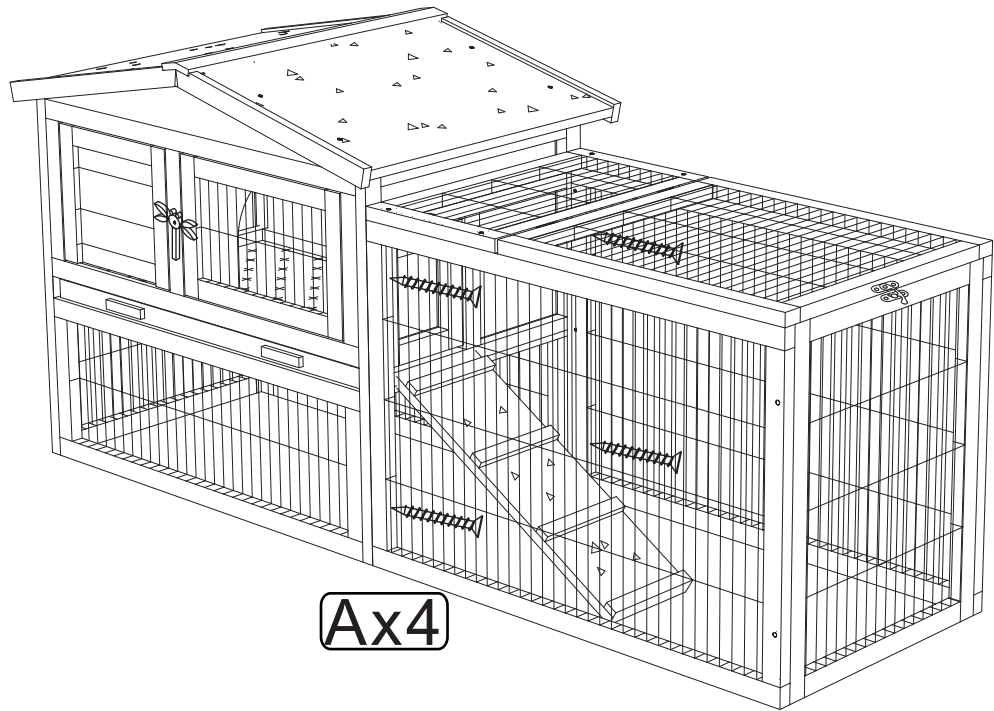

Ax4

