

ATTENTION

PLEASE READ THE INSTRUCTION BEFORE ASSEMBLING THE TRICYCLE, TO AVOID ANY DAMAGE AND INJURIES TO YOUR BABY.

NOTICE

1. NEVER LEAVE YOUR CHILD UNATTENDED WHEN IN USE.
2. PLEASE INSPECT ALL PARTS ARE ASSEMBLE CORRECT BEFORE USING.
3. THIS PRODUCT CAN BE USED AFTER ENSURE ALL PARTS ARE FIRMED AND ASSEMBLE BY AN ADULT.
4. AVOID USING TRICYCLE ON OR NEAR THRESHOLD, STAIRS OR IRREGULAR PLACES, IT MAY RESULT IN SERIOUS INJURY.
5. DO NOT USE TRICYCLE ON THE SLOPE DRIVEWAY, ROAD OR STREET.
6. AVOID PUT THE TRICYCLE IN THE WET, COLD OR HOT ENVIRONMENT FOR A LONG TIME. KEEP AWAY FROM THE FIRE.
7. DO NOT OVERLOAD THE TRICYCLE WITH MORE THAN 25KGS WEIGHT.
8. THIS TRICYCLE IS FIT FOR CHILDREN OF 1.5- 5 YEARS OLD.
9. DO NOT USE ALLOW CHILD TO PUSH THE TRICYCLE WHEN THERE IS A BABY USE IT.
10. PLASTIC BAGS MAY BE DANGEROUS. KEEP AWAY FROM THE REACH OF CHILDREN TO AVIOD SUFFOCATION HAZARDS.
11. HIGHLIGHT THE POTENTIAL RISKS OF SHARP POINTS OREDGES.
12. A REMINDER THAT THE TOY SHOULD BE USED WITH CAUTIONS SINCE SKILL IS REQUIRED TO AVOID FALLS OR COLLISIONS CAUSING INJURY TO THE USER OR THIRD PARTIES.

WARNING

1. WARNING! ASSEMBLY BY AN ADULT!
2. KEEP AWAY FROM THE STREET AND MOTOR ROAD, KEEP YOUR KIDS IN VIEW.
3. USE TRICYCLE ON SAFE ROAD ONLY AND KEEP YOUR ATTENTION WHILE IN USE.
4. KEEP AWAY ALL SMALL PARTS FROM BABY TO AVOID SWALLOWING.
5. DO NOT OVERLOAD MORE THAN 25KGS.
6. DO PUT AWAY THE PLASTIC BAGS TO AVOID SUFFOCATION WHEN PLAYING.
7. DO PLAY THIS TRICYCLE IN RIGHT WAY.

MAINTENANCE

1. CLEANNESS: CLEAN THE TRICYCLE BY SOFT CLOTH INSTEAD OF AUTO WAX OR WATER AVOIDING DEGENERATING.
2. STORAGE: KEEP AWAY FROM FIRE, DAMP AND OTHER HIGH TEMPERATURE AREA
3. PLEASE INSPECT SCREW PERIODICALLY TO ENSURE IT IS NOT LOOSE.

PARTS NAME

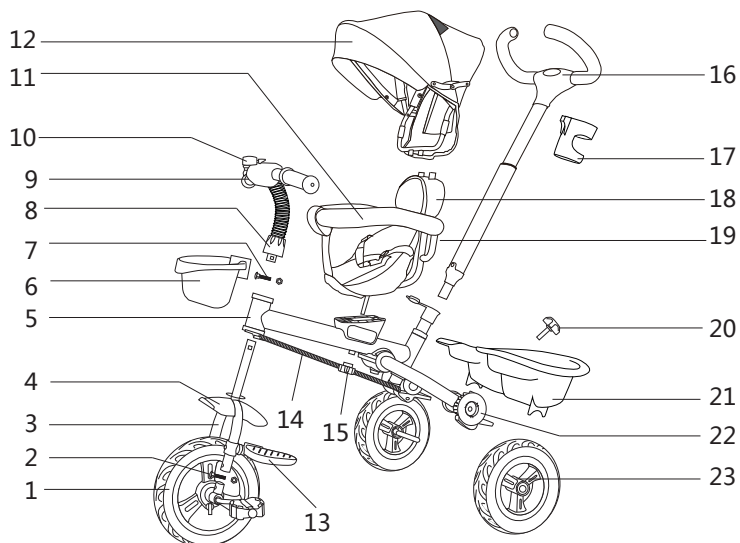

1. FRONT WHEEL ASSEMBLY
2. FRONT FIRM SCREW
3. FRONT FORK
4. FENDER
5. MAIN FRAME
6. FRONT BASKET
7. HANDLE FIRM SCREW
8. OVERLAY
9. BELL
10. HANDLE COVER
11. GUARDRAIL
12. CANOPY
13. FOOTREST
14. DIRECTION CONTROL SYSTEM
15. ROTATE SEAT BUTTON
16. PUSH BAR
17. BOTTLE CARRIER
18. BACKREST
19. SEAT FABRIC
20. REAR BASKET SCREW
21. REAR BASKET
22. BRAKE
23. REAR WHEEL ASSEMBLY

INSTALLATION

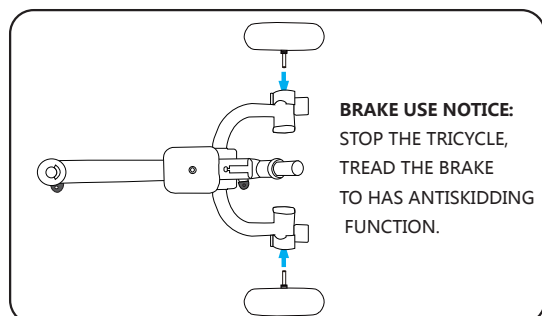

1. AS PICTURE, PUT TWO REAR WHEELS INTO THE TUBE UNTIL HEAR THE LOCK SOUND.

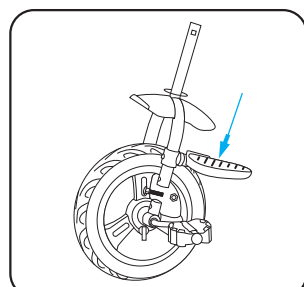

2. AS PICTURE, TWO SIDES PLASTIC INSERT THE TWO SIDES OF FRONT FORK TUBE, FIX WITH SCREW.

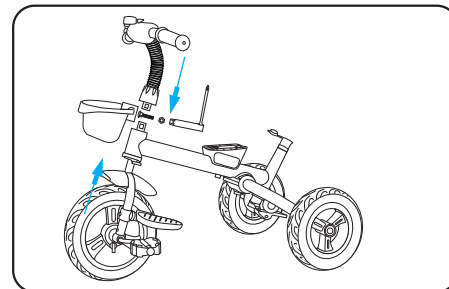

3. AS PICTURE, PUT THE FRONT WHEEL ASSEMBLY INTO THE MAIN FRAME; PUT THE OVERLAY ON THE HANDLE, PUT THE BASKET ON THE UP-TUBE OF FRONT FORK, FRONT FORK TUBE INSERT HANDLE TUBE, FIX WITH SCREW; PUT DOWN THE OVERLAY.

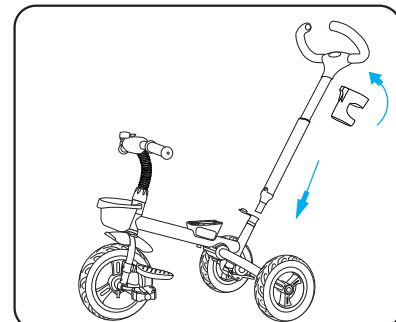

4. AS PICTURE, PUT THE PUSH BAR INTO THE REAR FRAME TUBE UNTIL HEAR THE LOCK SOUND; PUT THE BOTTLE ON THE PUSH BAR.

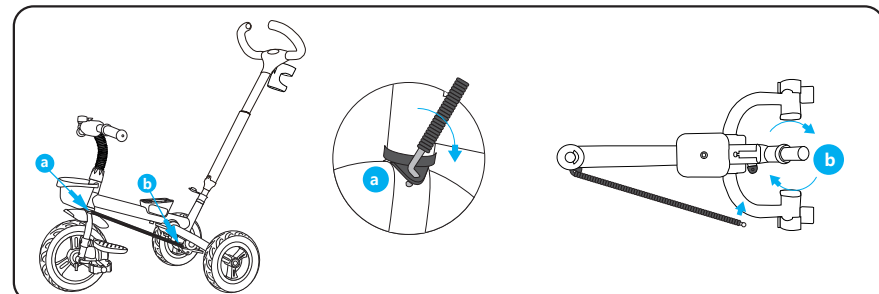

5. AS PICTURE, REMOVE NUT OF DIRECTION CONTROL MENTAL ON THE REAR FRAME. PUT THE FRONT OF MENTAL INTO THE HOLE OF FRONT FORK a. KEEP FLAT, ENSURE CONNECT GOOD WITH FRONT FORK; TURN PUSH BAR TUBE, PUT THE TUBE HOLE b ADJUST UNTIL CAN PUT THE REAR DIRECTION CONTROL MENTAL INTO THE HOLE; FIX WITH SCREW.

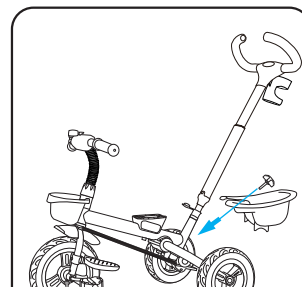

6. AS PICTURE, PUT THE REAR BASKET ON THE FRAME, FIX WITH SCREW.

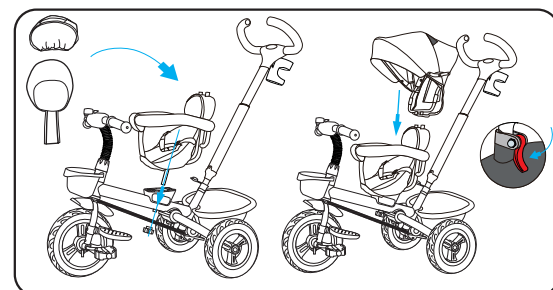

7. AS PICTURE, PUT THE BLACK PLASTIC ON THE FRAME, INSERT THE SEAT BOLT THROUGH THE HOLE, FIX WITH SCREW; PUT ON THE SEAT FABRICS.

8. AS PICTURE, PUT THE CANOPY TUBE INTO THE BACKREST TUBE AND PRESS DOWN THE GREY TWO PLASTICS WITH LOCKED.

KIDS TRICYCLE

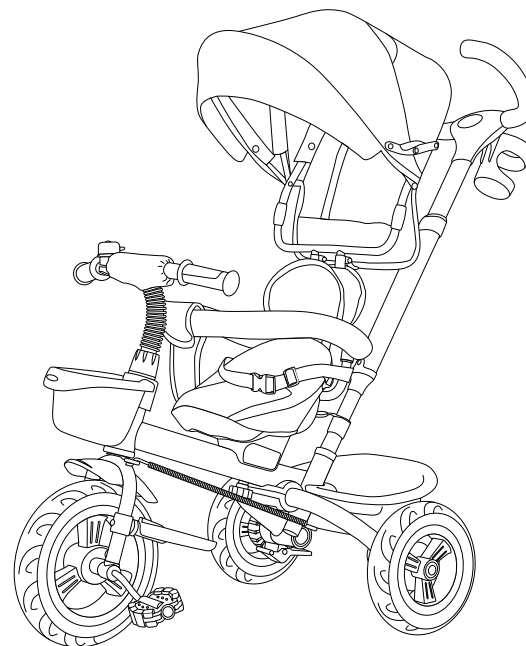

370-061

IMAGE IS FOR EXPLANATORY PURPOSE. FEATURES SHOWN MAY NOT BE PART OF THE ACTUAL TOY