

# AGG916

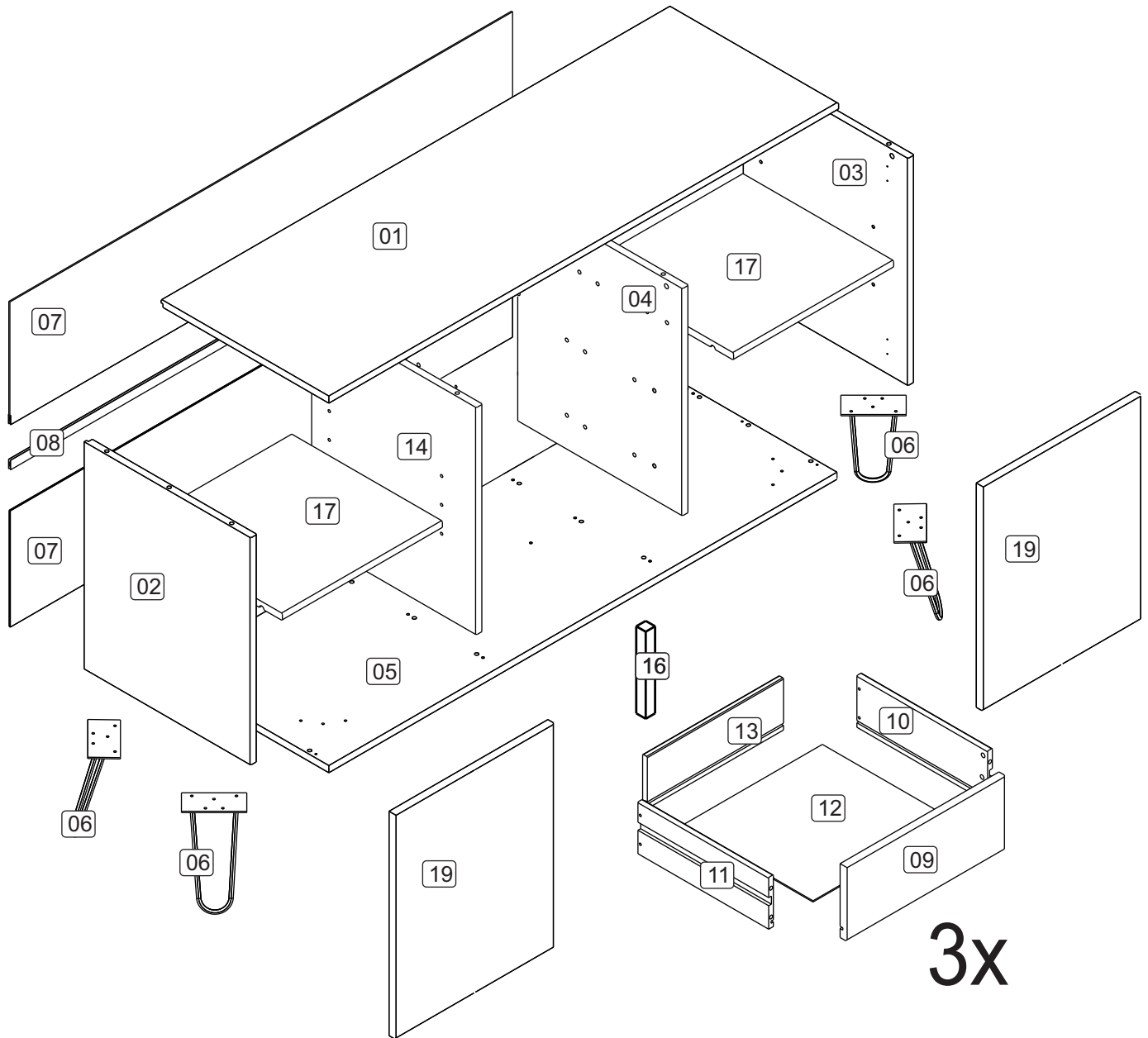

A MEMBER OF  
**ACID**<sup>®</sup>  
ANTI COPYING IN DESIGN

Core Products are proud to be a member of ACID (Anti Copying in Design). Our designs are supported through their intellectual property databank. All copyright, design rights & intellectual property rights existing in this product, instructions and related documents are and will remain the property of Core Products. We will treat any infringement of these rights seriously.  
Copyright © Core Products 9/2020



# AGG916

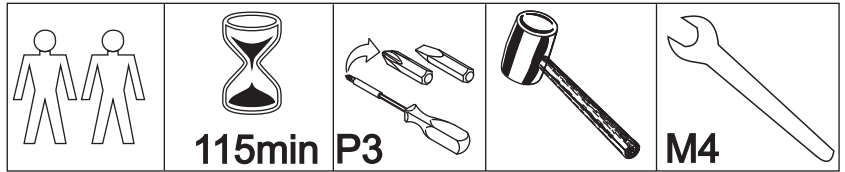

Thank you for choosing this furniture.

**BEFORE YOU START ASSEMBLY** please store the carton at room temperature for 48 hours or more so the contents can acclimatise.

**PLEASE RETAIN ALL PACKING UNTIL YOU HAVE COMPLETED ASSEMBLY.**

Information about your furniture.

This furniture range has been manufactured from surface coated wood based manufactured boards.

Caring for your furniture.

Extreme temperature can cause panels to distort so please avoid placing your furniture close to radiators or other sources of heat. Humidity should also be avoided.

Please avoid exposing your furniture to continued bright sunlight as this may affect the colour.

Any fluid spills should be removed as quickly as possible.

Always lift your furniture when moving as dragging may cause damage to your furniture or flooring.

After care.

Wipe surfaces with a dry cloth and an occasional use of a slightly dampened cloth.

To remove any stains, use a household cream cleaner.

For models with drawers we also recommend you use a household spray polish or silicone curtain track spray on the drawer runner tracks.

Please do not use any wax based products, detergents or chemicals on your furniture.

## PARTS LIST

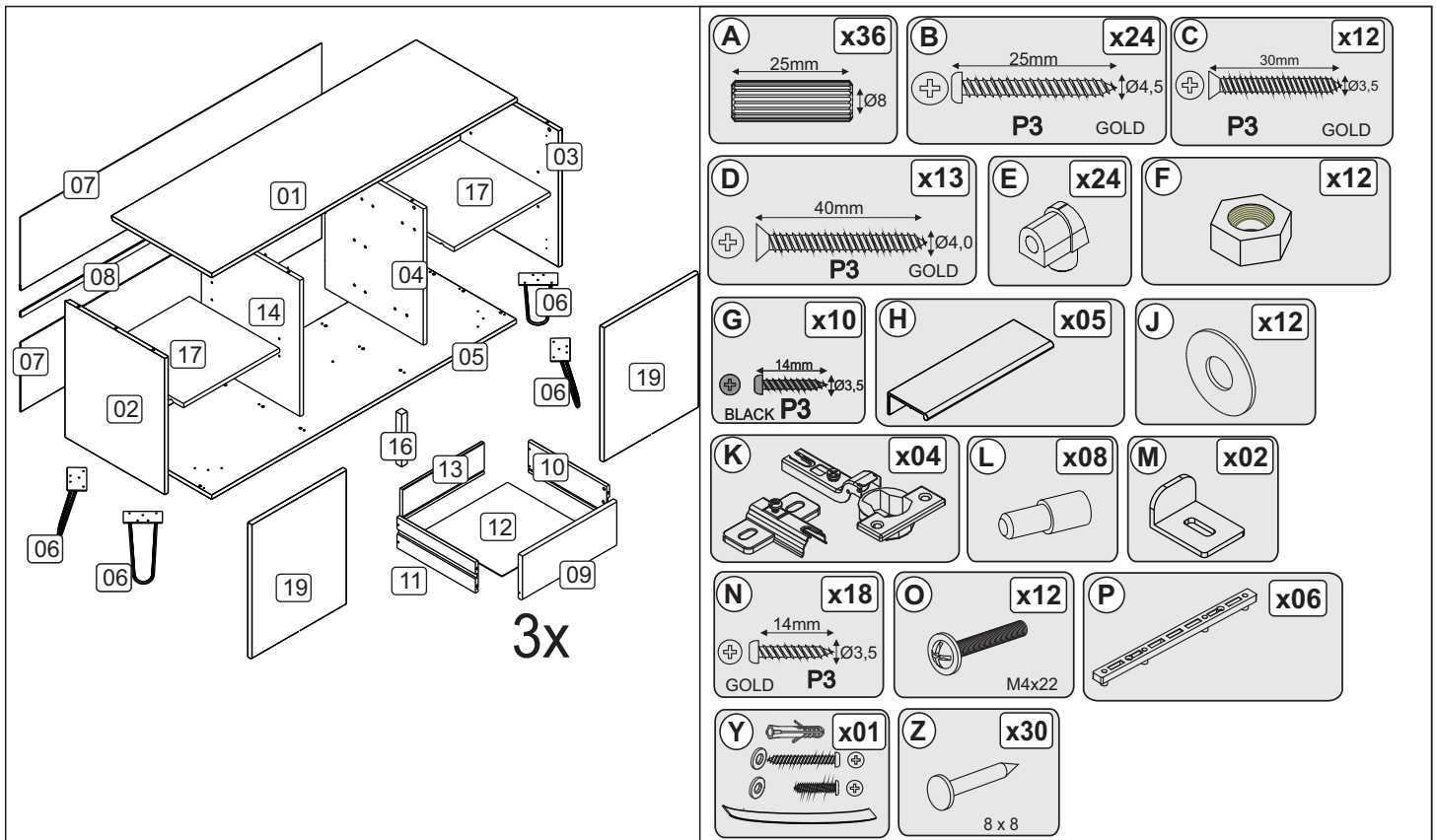

### BEFORE YOU START ASSEMBLY

Please check that you have all the correct parts and fittings as detailed on the assembly instructions.

### FOR DAMAGED/REPLACEMENT PARTS

Please visit

[www.coreproducts.co.uk/parts](http://www.coreproducts.co.uk/parts)

Batch Number 2020-0270

### 2021 SPECIFICATION

**PLEASE RETAIN THIS LEAFLET ALONG WITH YOUR DELIVERY NOTE/RECEIPT FOR FUTURE REFERENCE**

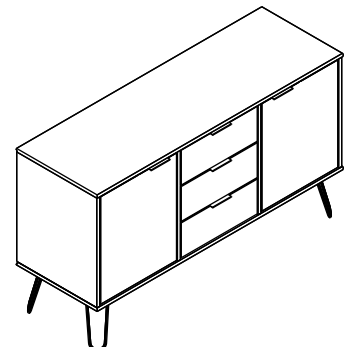

# 01

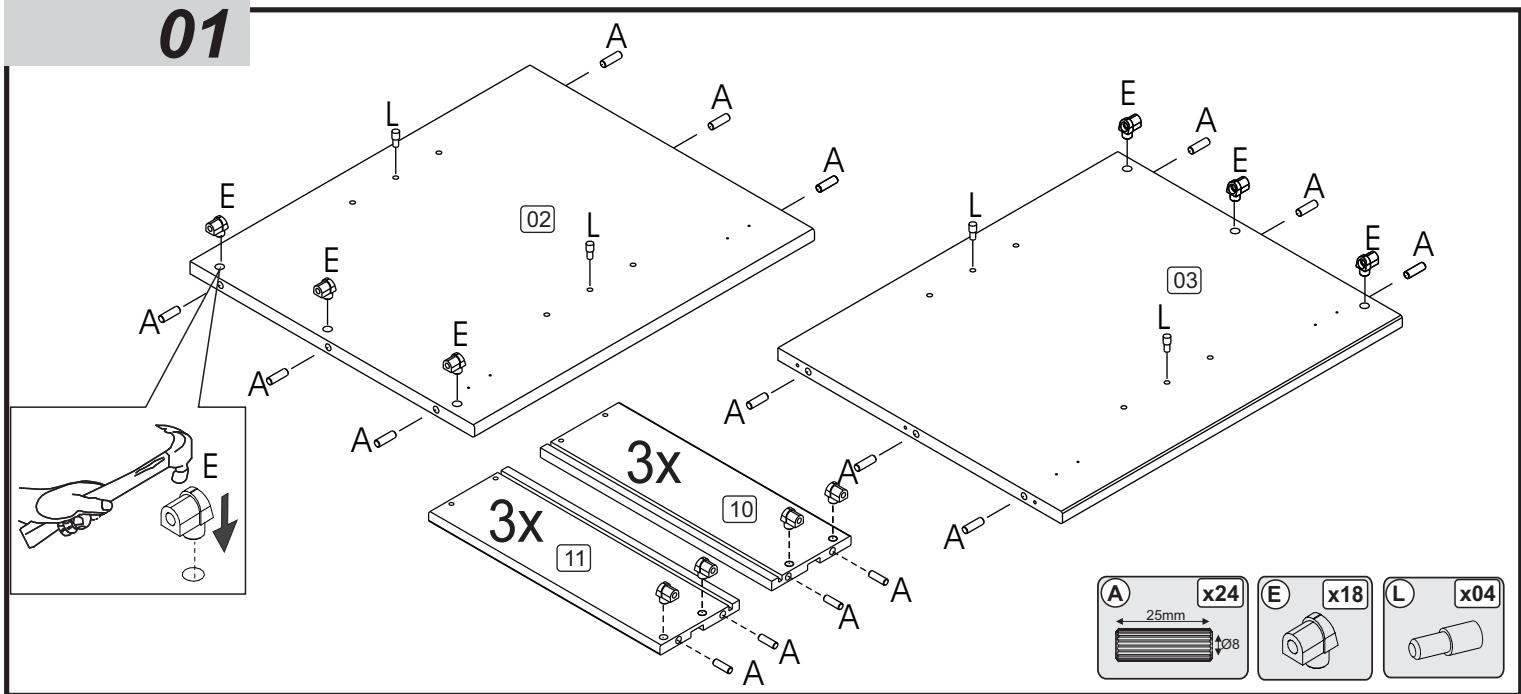

# 02

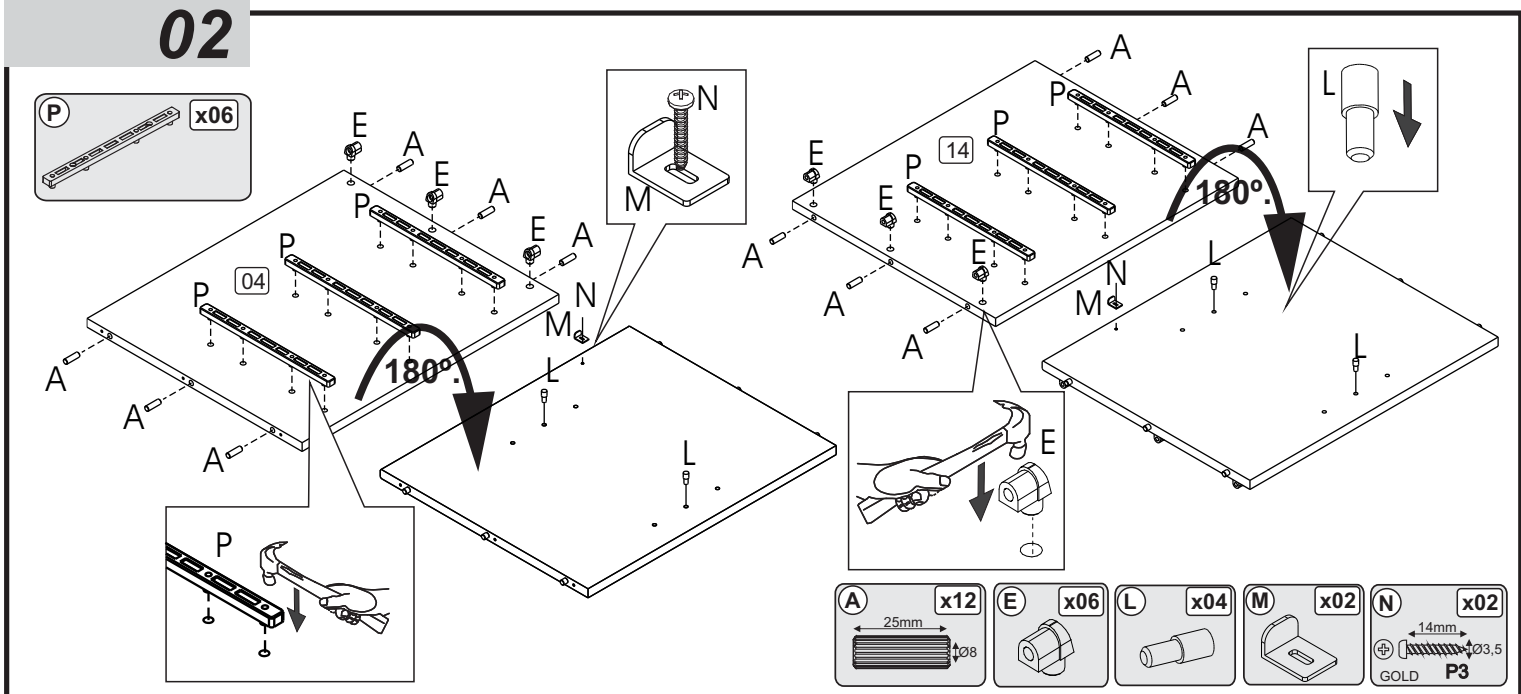

# 03

To avoid damage to your furniture during assembly please build on a soft clean surface such as the inside of the cardboard box.

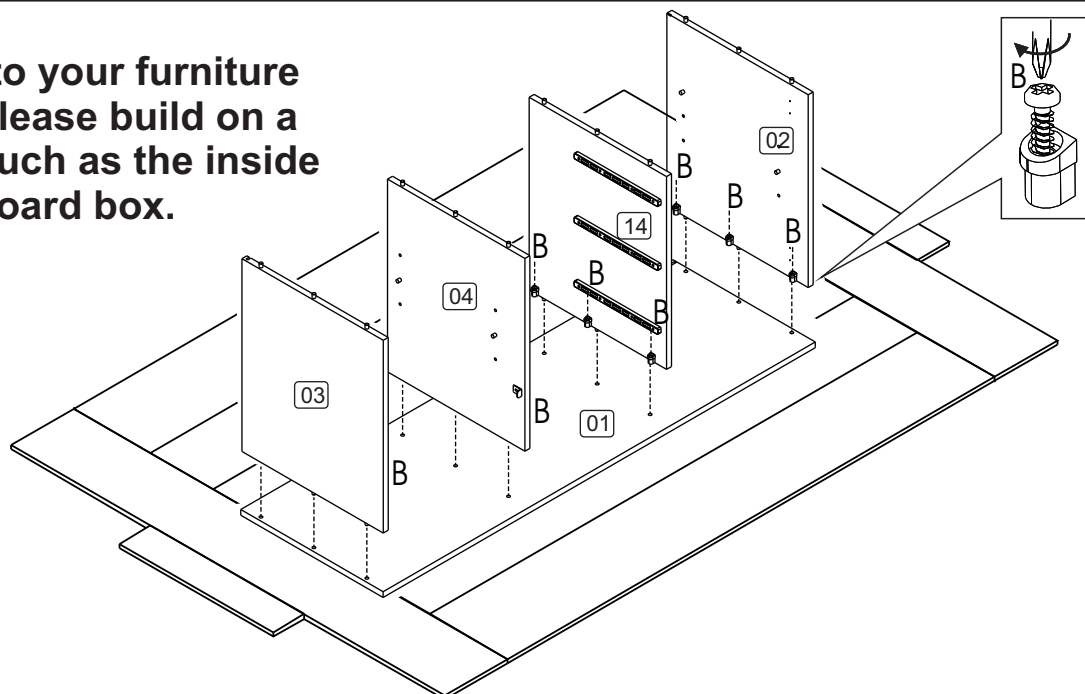

# 04

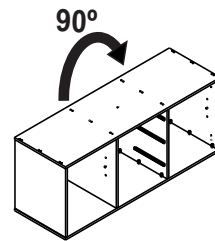
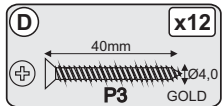
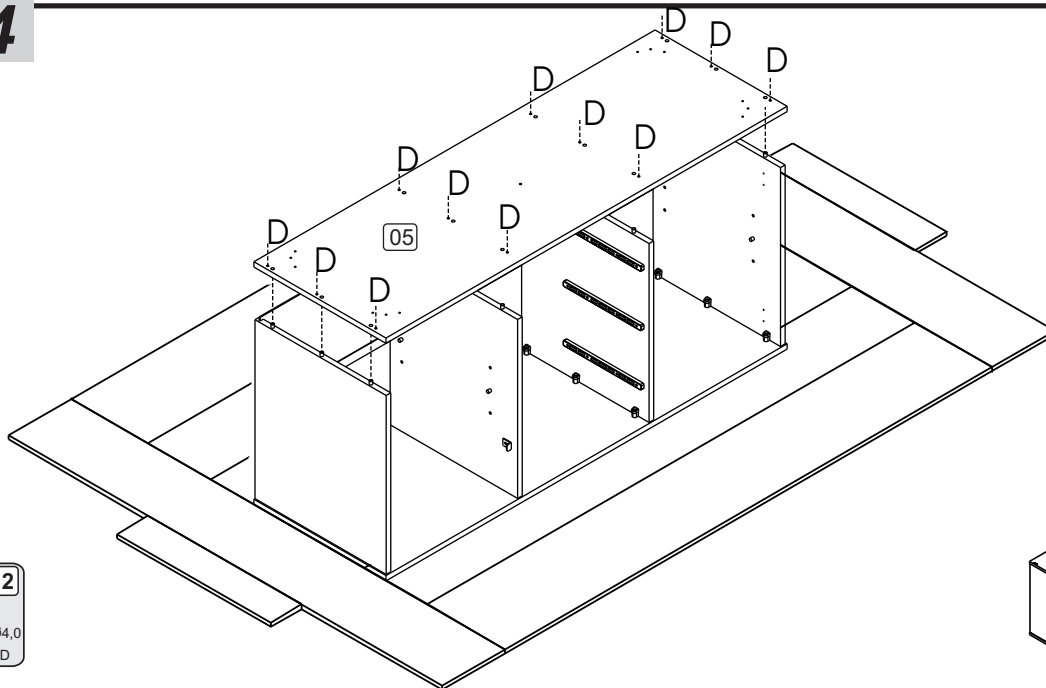

# 05

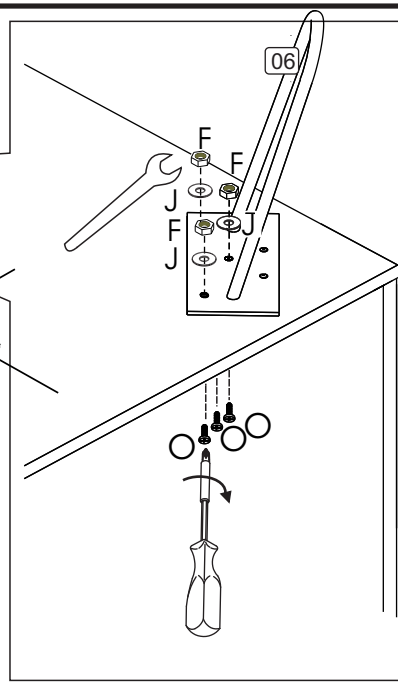
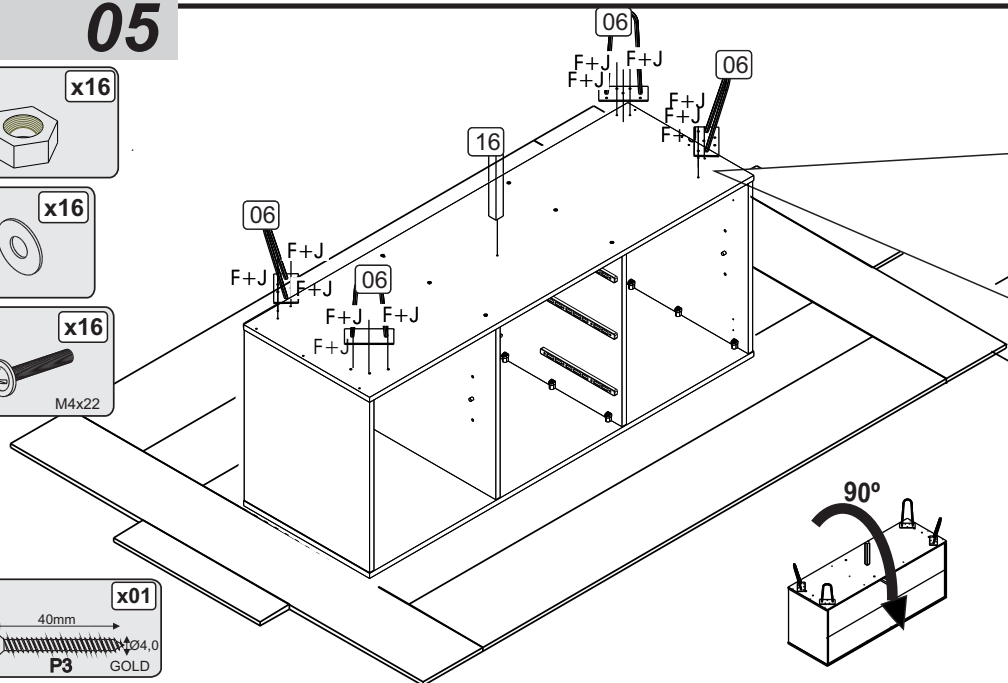
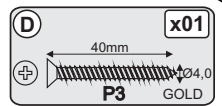
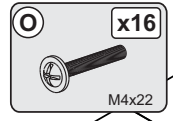
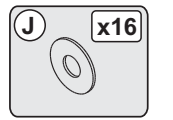
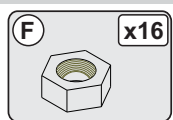

# 06

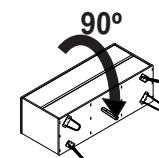
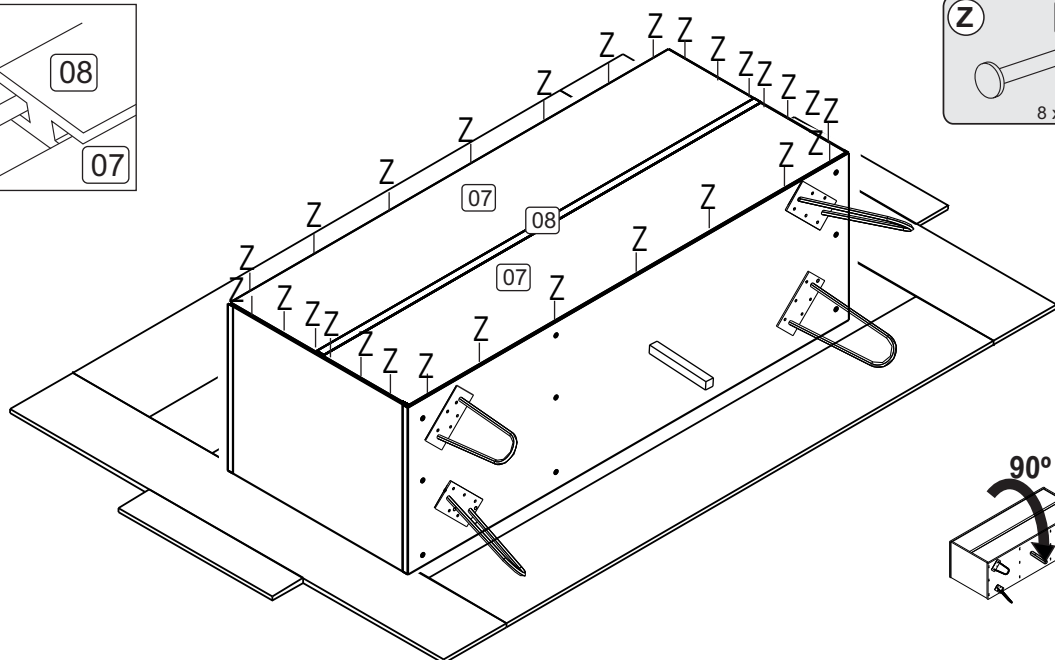
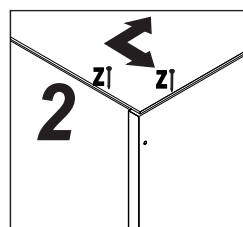
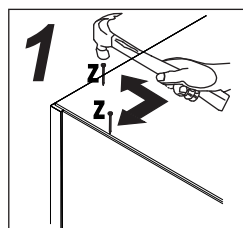
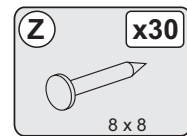
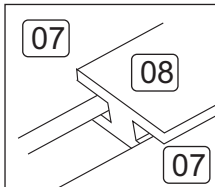

# 07

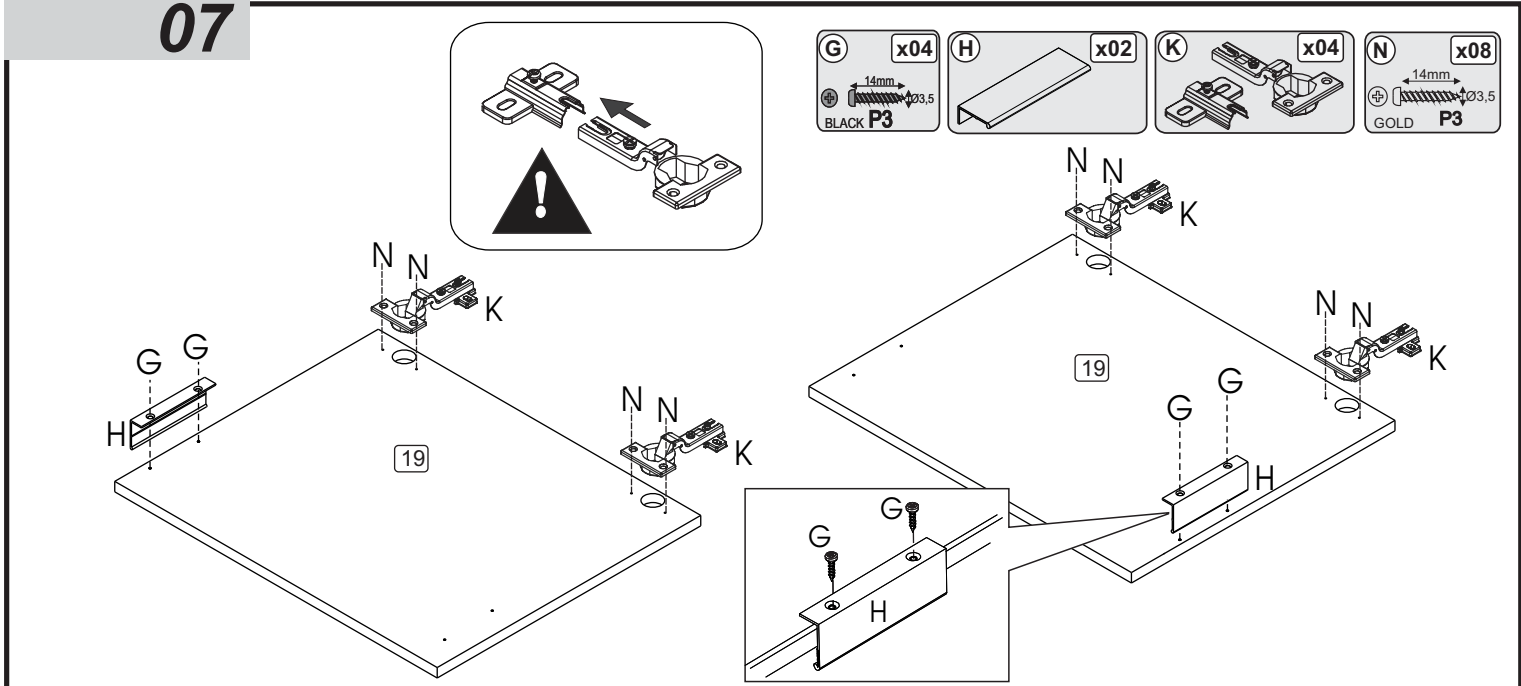

# 08

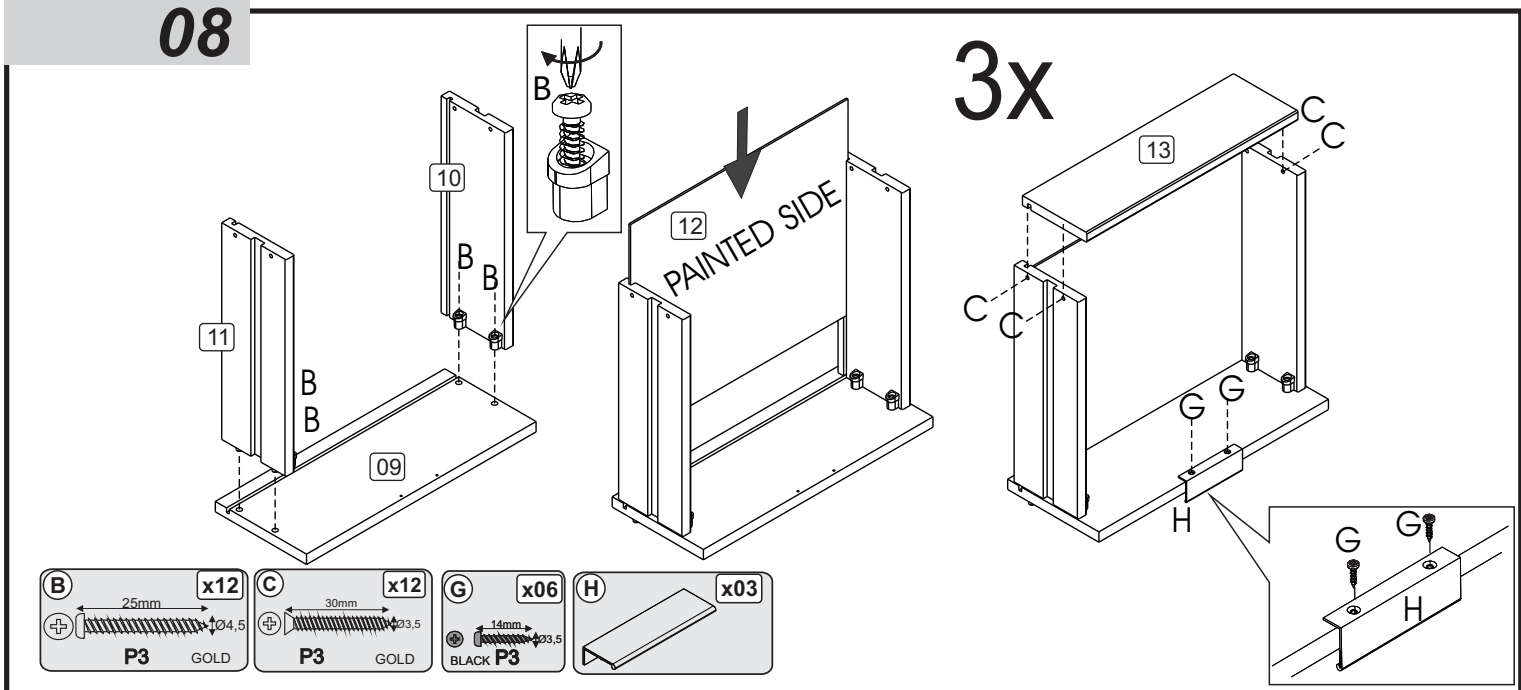

# 09

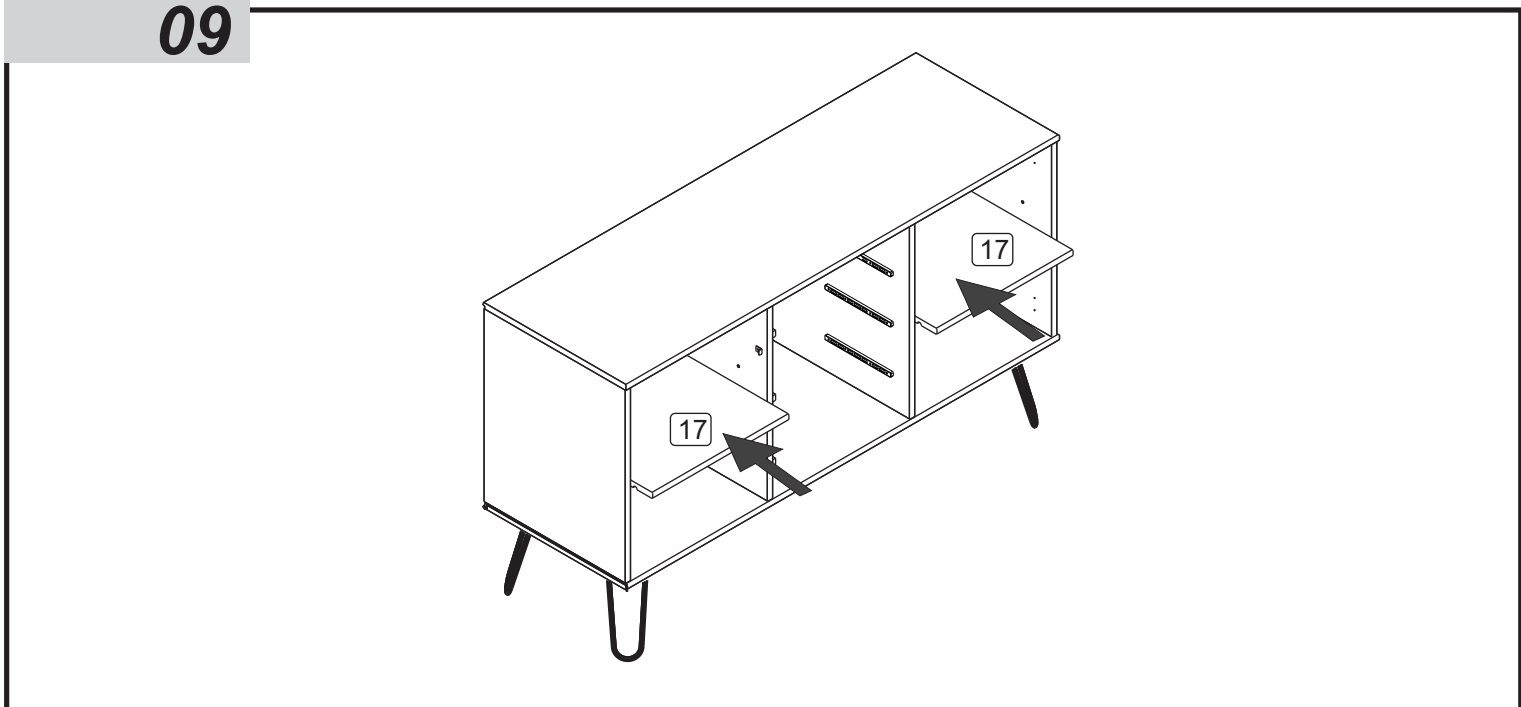

10

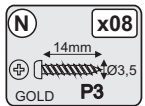
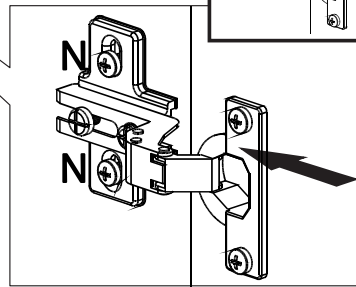
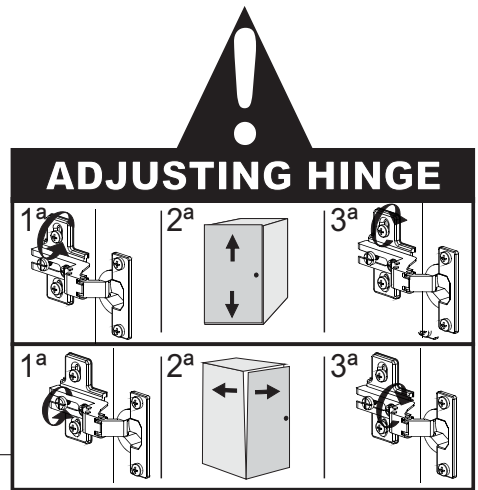
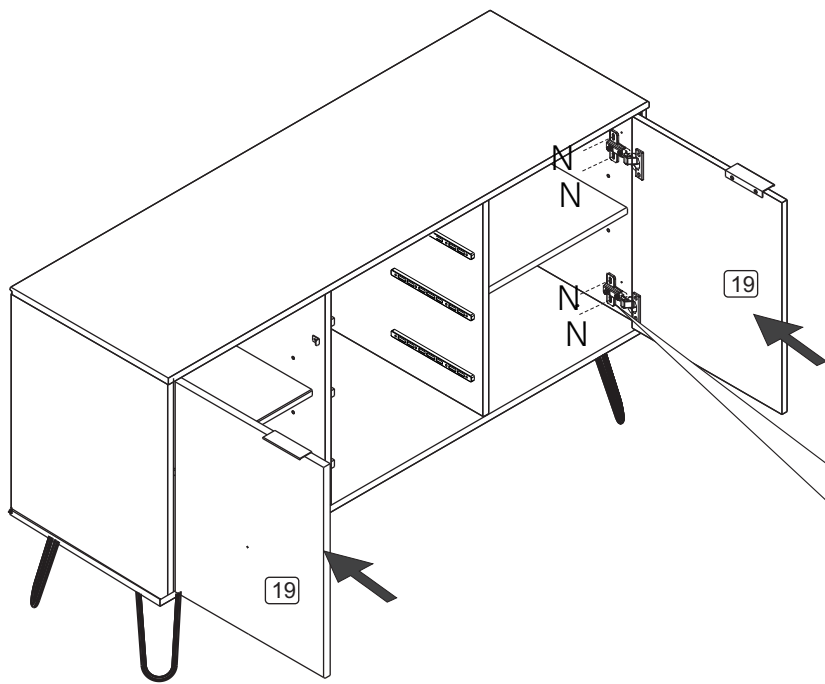

11

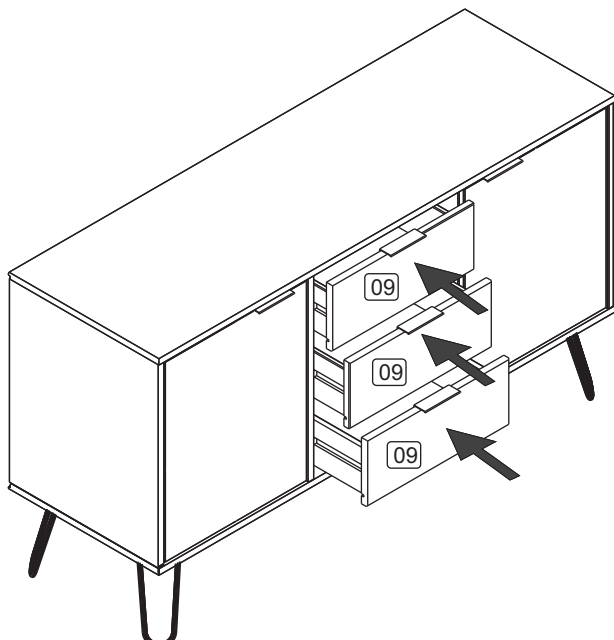

**IMPORTANT NOTICE**

Please avoid opening all drawers or doors simultaneously as this could cause your furniture to fall forwards. Where there is a risk of this occurring, especially in environments with children or uneven floors we recommend that this item of furniture is attached to your wall using appropriate fixings (supplied).

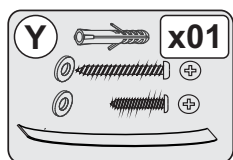
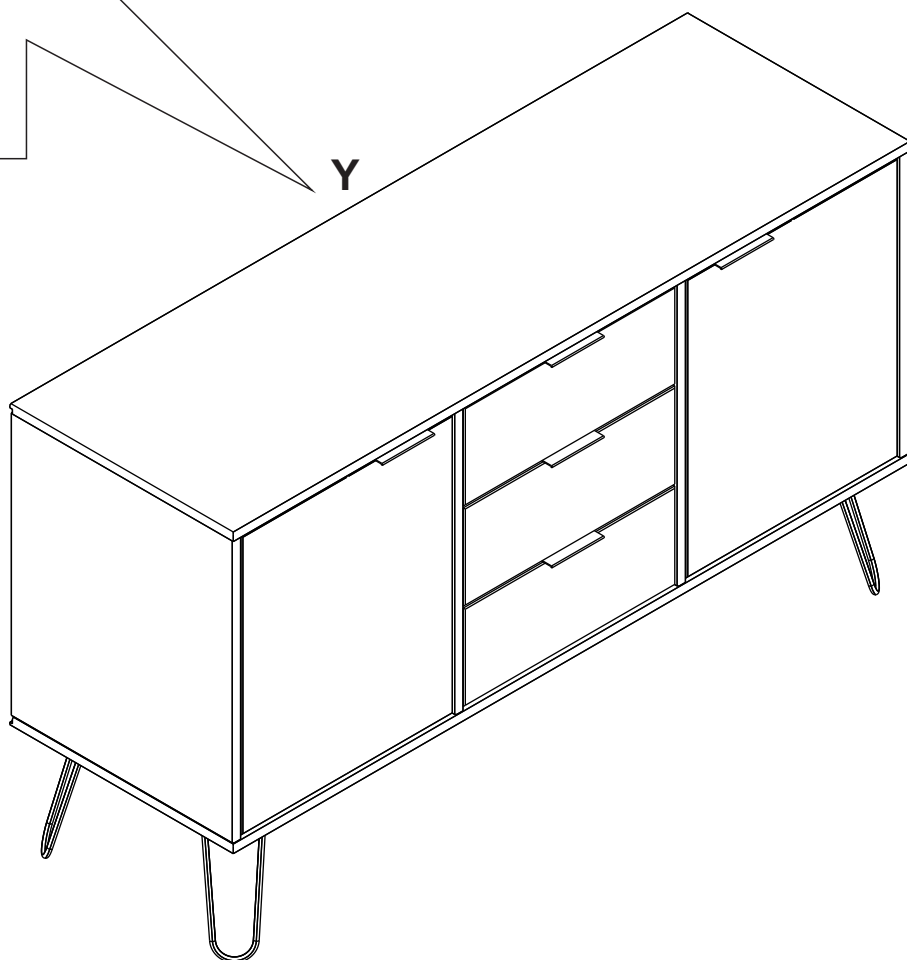
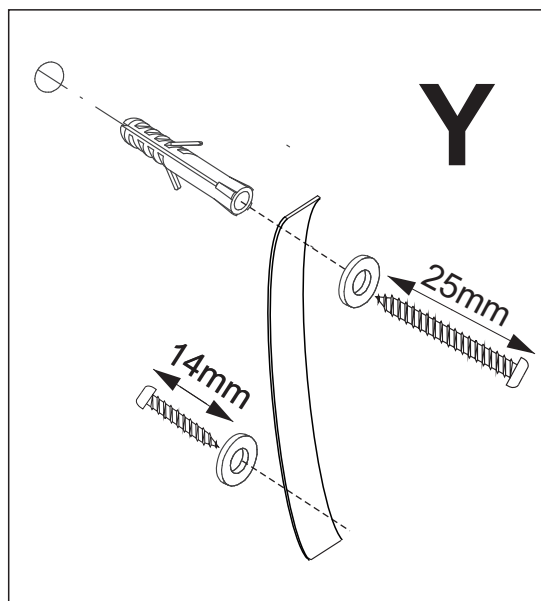

**WARNING: CHECK FOR HIDDEN PIPES AND CABLES BEFORE DRILLING.**

**IMPORTANT: IF YOUR WALLS ARE NOT SOLID LIKE BRICK OR STONE, YOU WILL REQUIRE SPECIALIST FITTINGS (NOT SUPPLIED).**

- Place fixing strip against the wall and mark position for drilling hole.
- Drill hole in your wall to a depth of 30mm using a 6mm drill bit. If the surface of your wall is soft and crumbly, we would advise you to use a 5mm drill bit for a tighter fit.
- Insert plug into hole with end flush to the wall surface.
- Attach fixing strip to the wall using the 25mm screw + washer and securely tighten.
- Pre-drill small pilot hole on the back edge of the furniture top using a 2mm drill bit. Attach the other end of fixing strip to the back edge of the furniture top using the 14mm screw + washer and securely tighten.