

NEVADA DISPLAY BOOKCASE WITH DOOR

REF. NE908

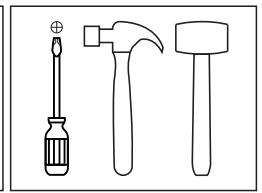
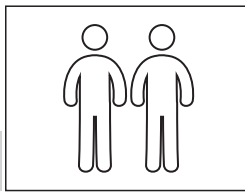

Thank you for choosing this furniture.

BEFORE YOU START ASSEMBLY please store the carton for 48 hours or more so the contents can acclimatise.

PLEASE RETAIN ALL PACKING UNTIL YOU HAVE COMPLETED ASSEMBLY.

Information about your furniture.

This furniture range has been carefully crafted from melamine faced manufactured board.

Each piece is manufactured to the highest standards using specialised computer controlled machinery to ensure accuracy.

Caring for your furniture.

Extreme temperature can cause slight movements in the board material so please avoid placing your furniture close to radiators or other direct sources of heat.

Please avoid exposing your furniture to continued bright sunlight as this can affect the colour.

Any fluid spills should be removed as quickly as possible.

Always lift your furniture when moving as dragging may cause damage to your furniture or flooring.

Always use place mats, coasters or tablecloths to help protect against scratches and accidentally dropped items. Always use heat resistant mats when placing hot or cold items on to surfaces.

Do not sit or stand on your furniture.

After care.

Wipe all surfaces with a dry cloth and the occasional use of a normal household furniture polish and a household glass cleaner on glass surfaces.

Please do not use detergents or chemicals on your furniture.

After assembly remove all visible component identification stickers, these should remove easily however any remaining adhesive residue can be easily removed with a label adhesive removal liquid available from most DIY or hardware stores.

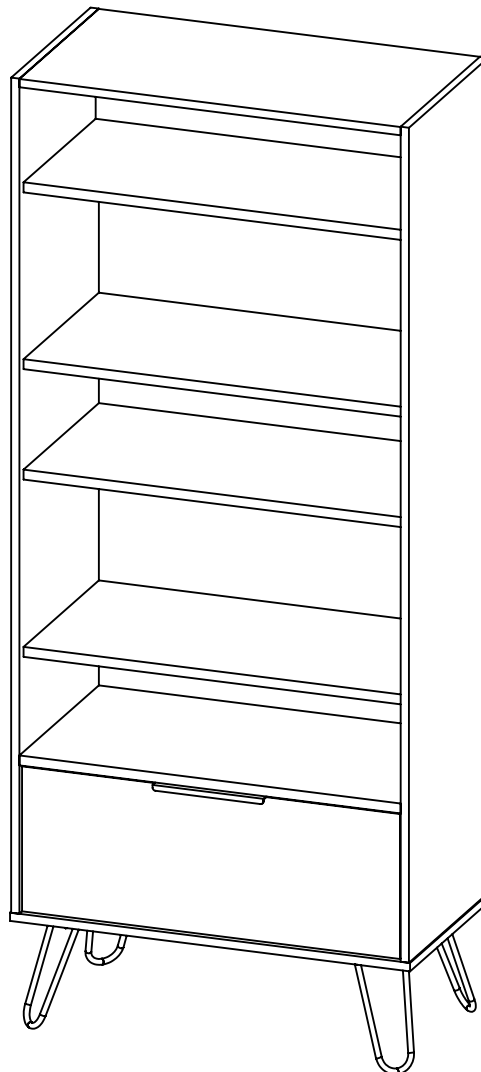

Height: 1712 mm
Width: 723 mm
Depth: 380 mm

BEFORE YOU START ASSEMBLY

Please check that you have all the correct parts and fittings as detailed.

In the unlikely event that you require to order spare parts or fittings please refer to your delivery note for details of how to order using our Parts website.

www.coreproducts.co.uk/parts

Customer help line 01738 630555

We recommend that you build your furniture on top of a soft clean cover to ensure the unit does not get marked or damaged during assembly.

BATCH NUMBER

02/10/2020

PLEASE RETAIN THIS INSTRUCTION LEAFLET FOR FUTURE REFERENCE.

ASSEMBLY HARDWARE



x48
Dowel



x26
Minifix Bolt



x26
Minifix Cams



(Colour 1)
x15
Cover Caps



(Colour 2)
x12
Cover Caps

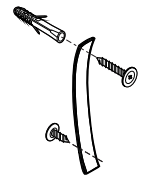

x1
Wall Fixing Kit
(Includes screws)

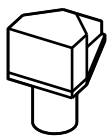

x1
Shelf Support

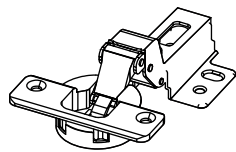

x2
End Panel Hinge
(EPH)
(Includes screws)

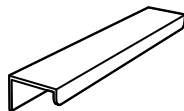

x1
Handle
Manija



x18
Flat Head Screw
(14mm)

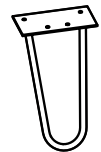

x4
Steel Leg

ASSEMBLY PARTS

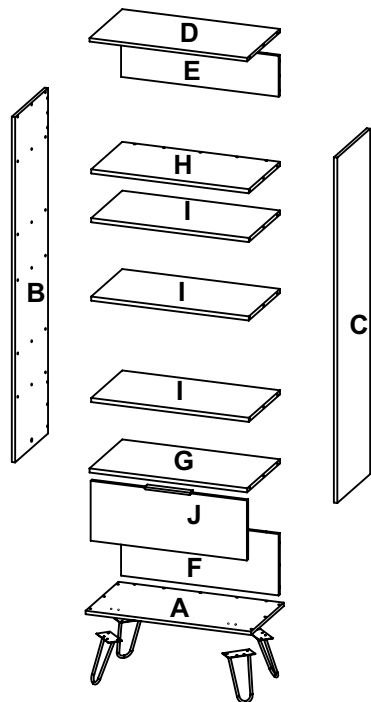

A - x1	E - x1	I - x3
B - x1	F - x1	J - x1
C - x1	G - x1	
D - x1	H - x1	

MAX SUGGESTED LOADS

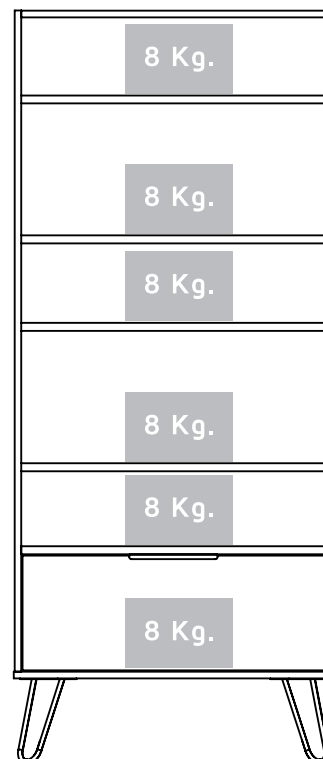

1

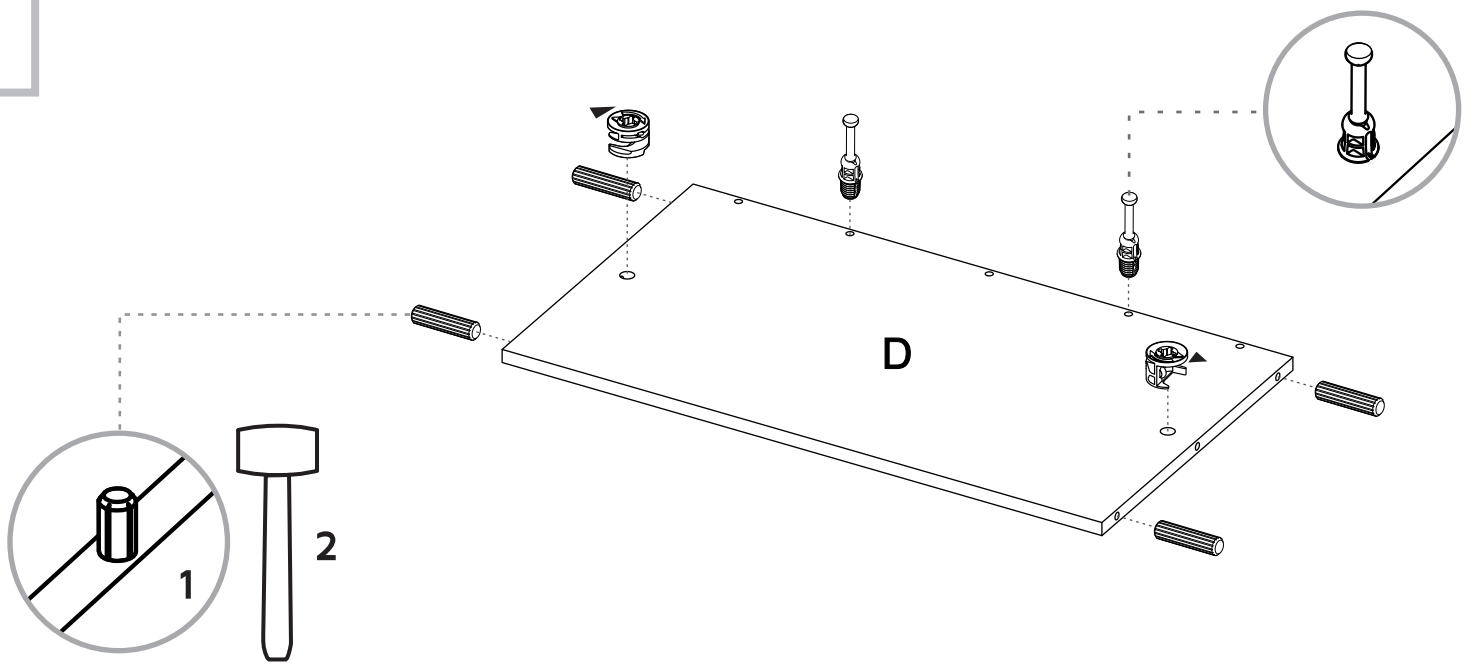

2

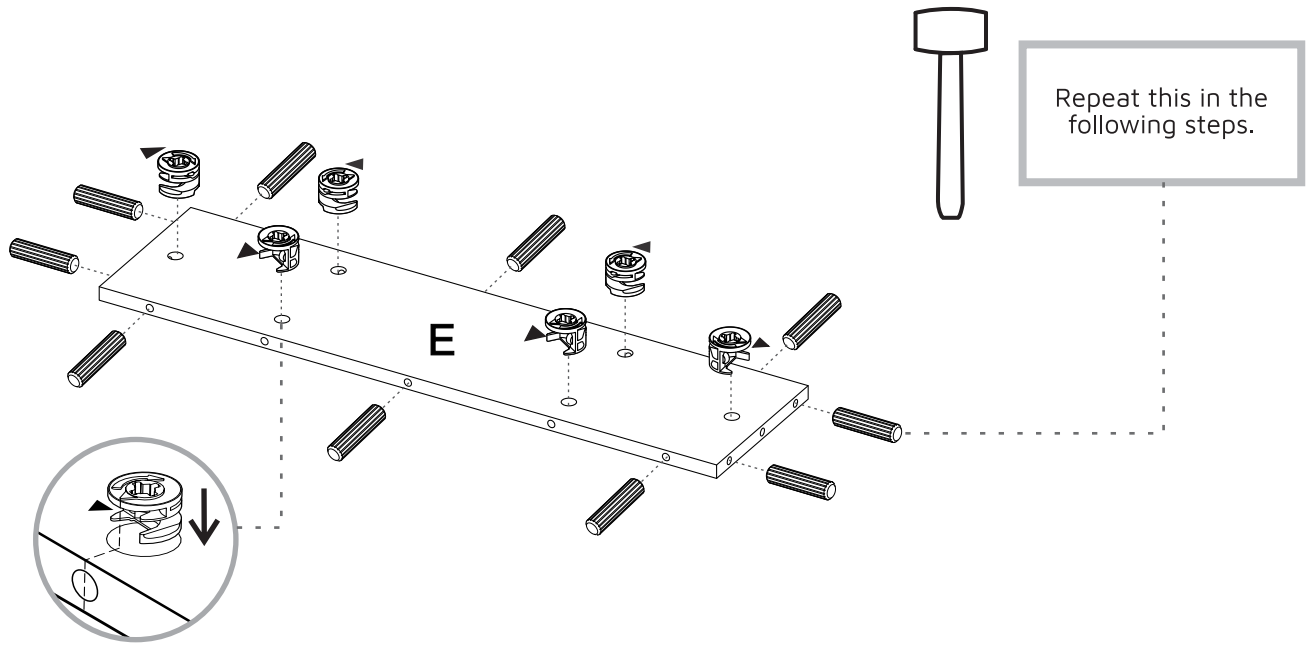

3

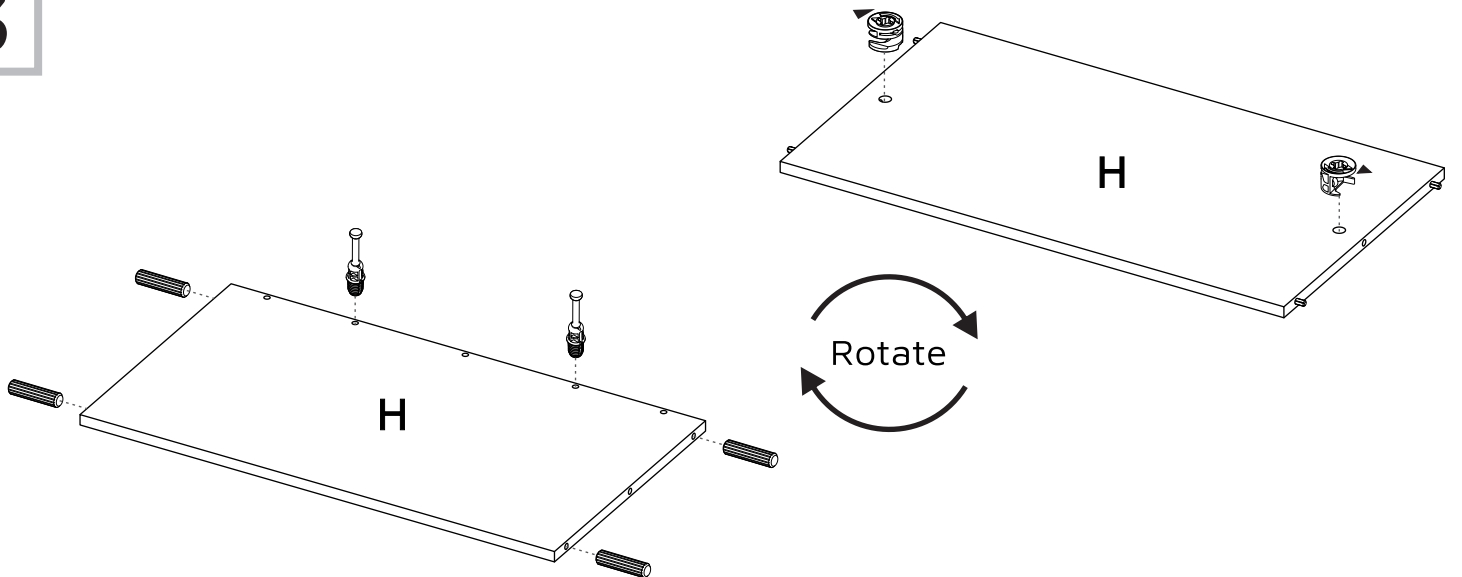

4

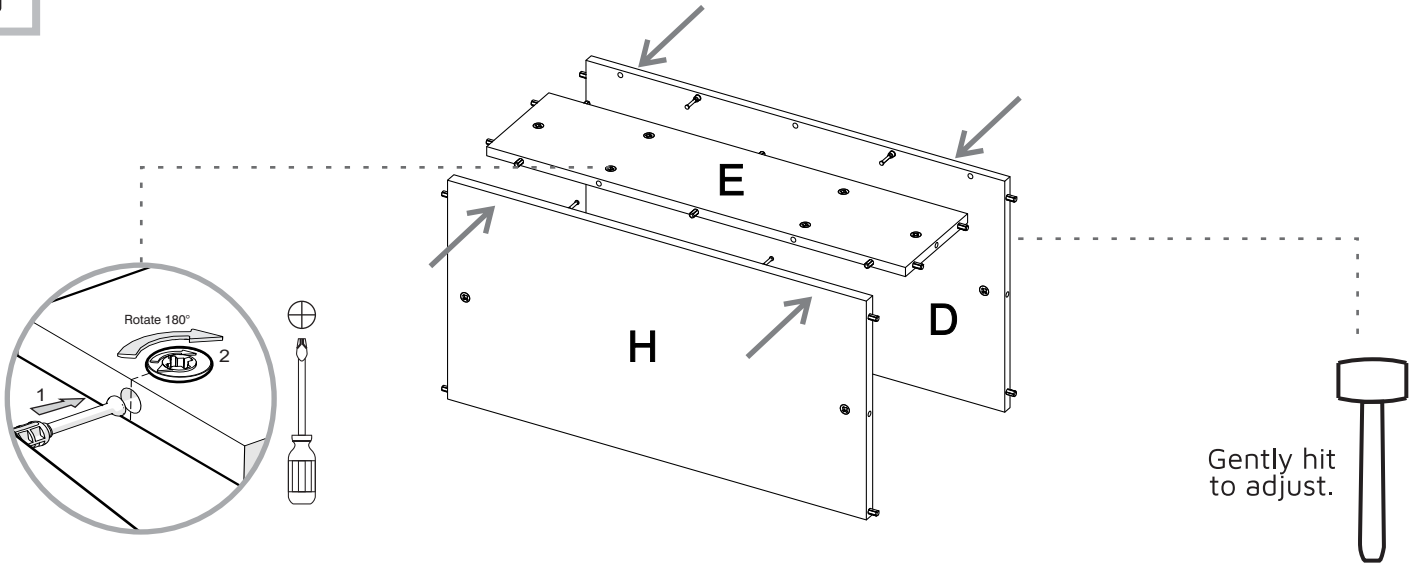

5

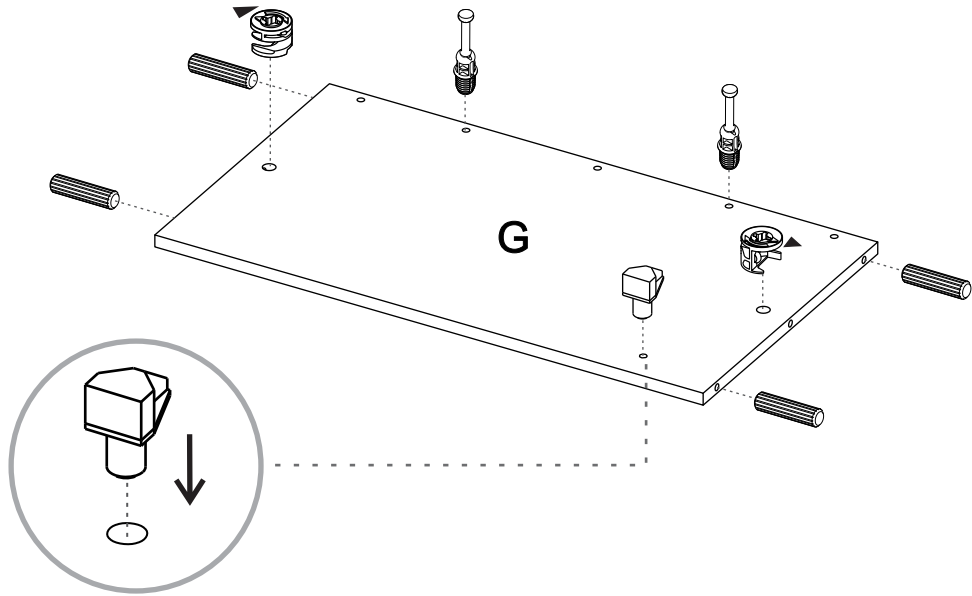

6

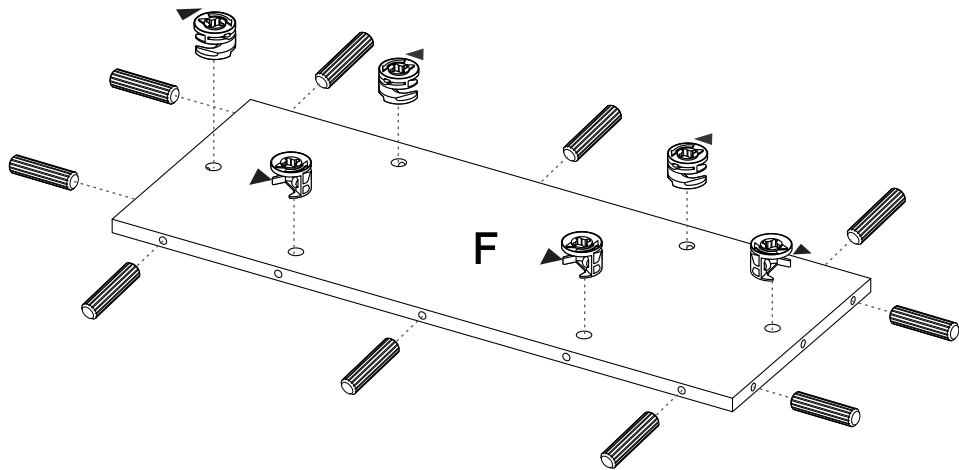

7

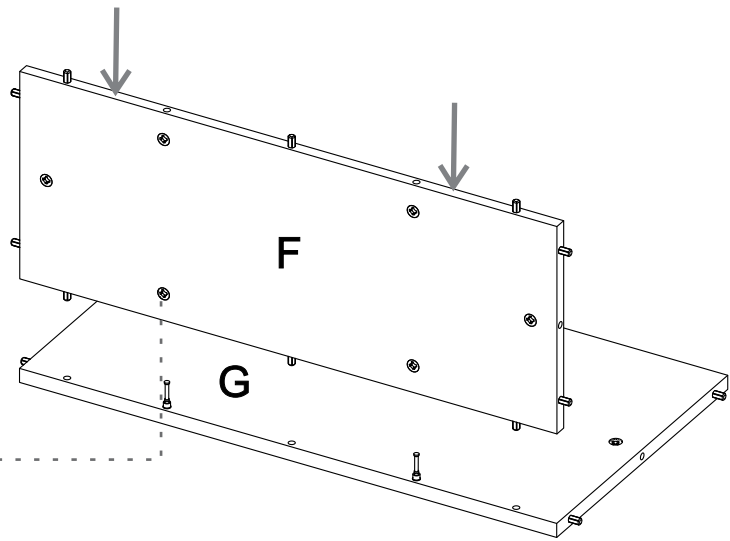
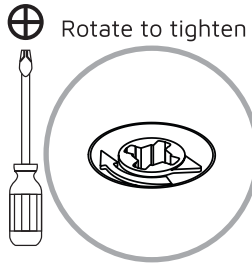

8

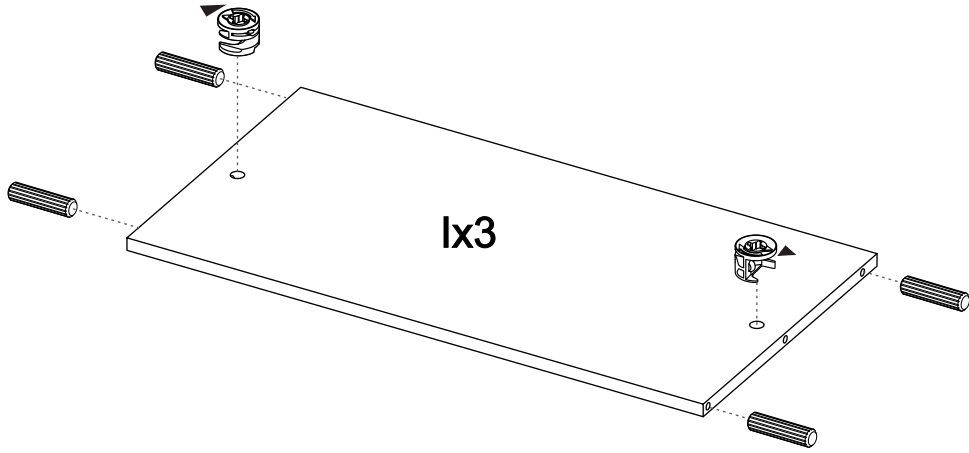

9

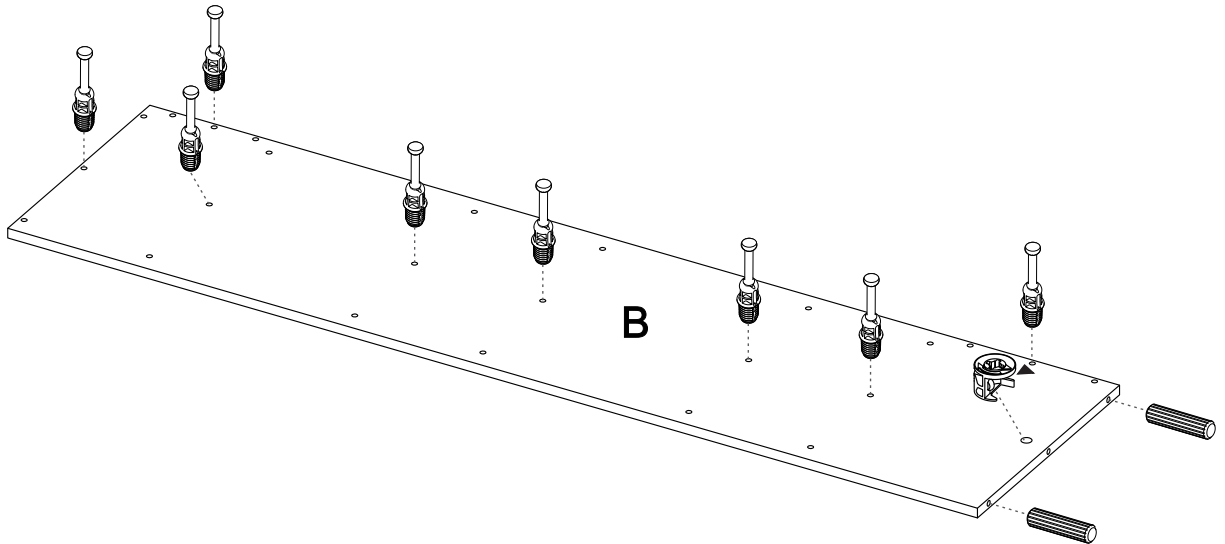

10

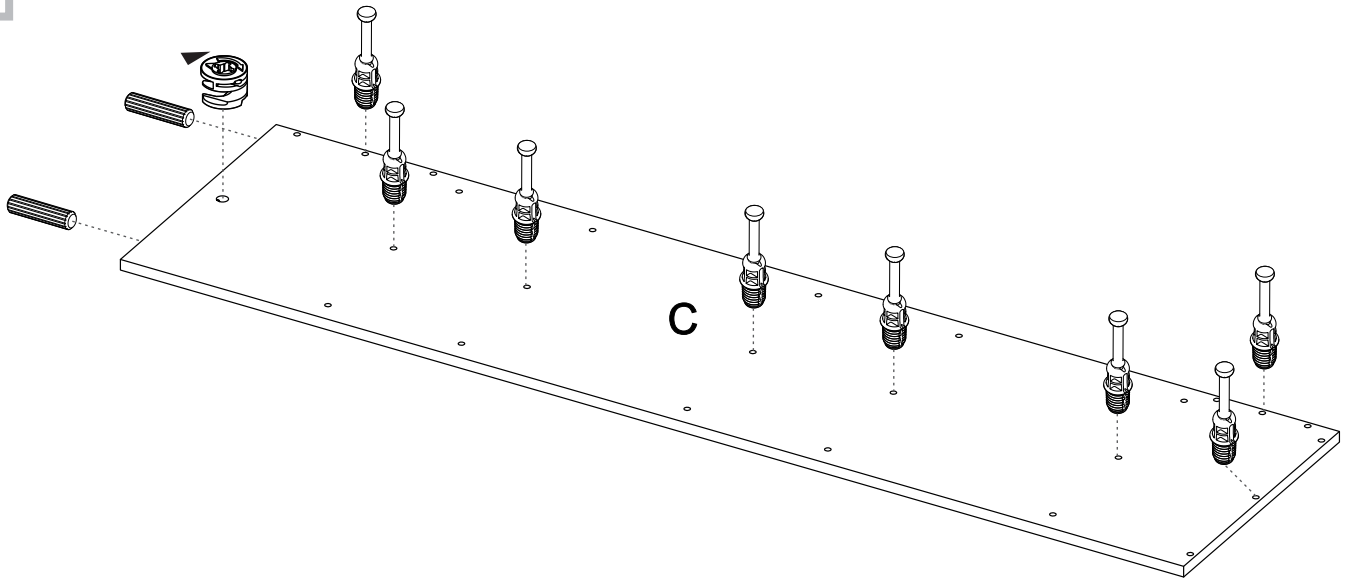

11

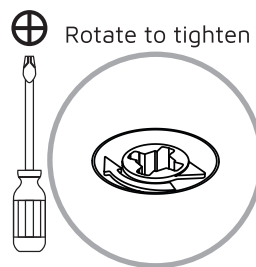
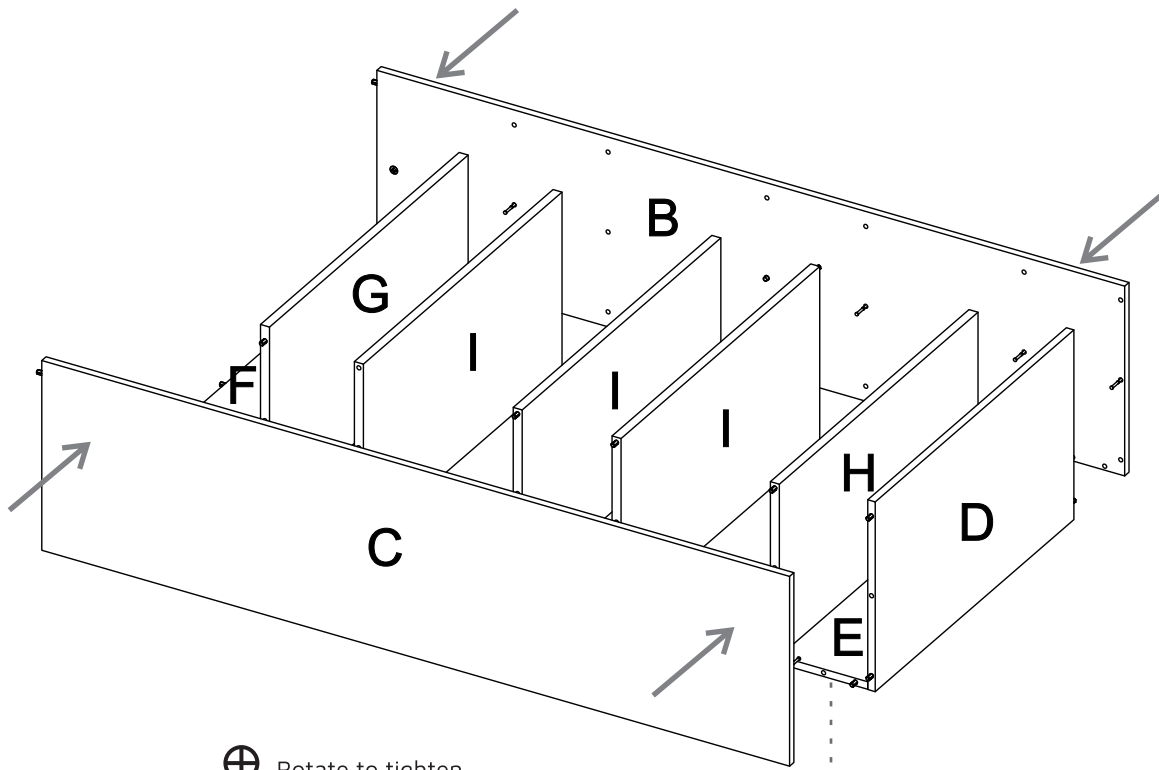

12

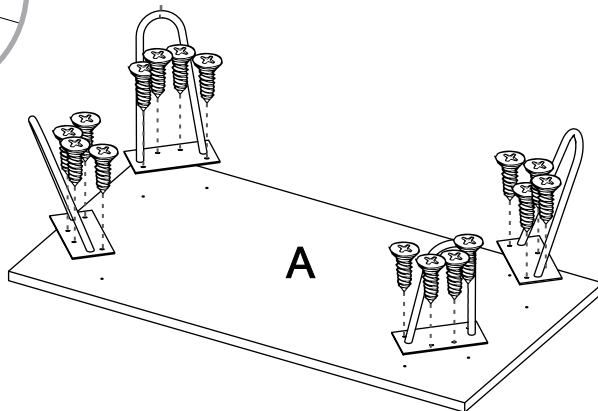
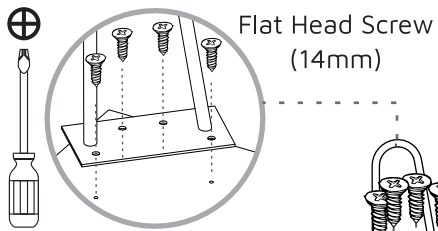

13

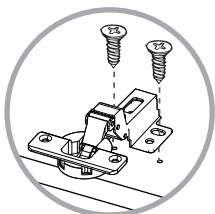
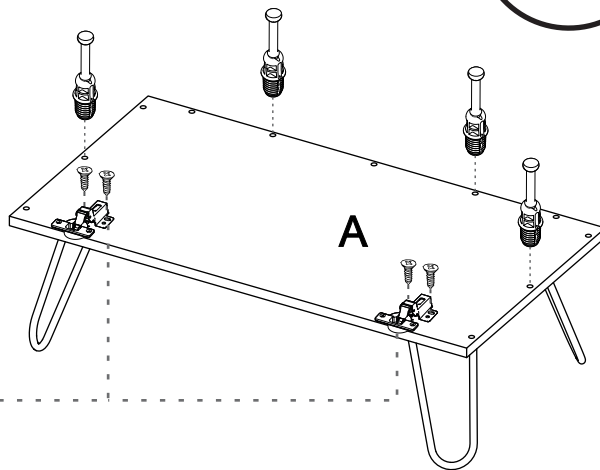
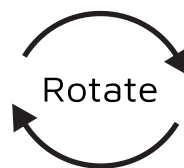

End Panel Hinge (EPH)

14

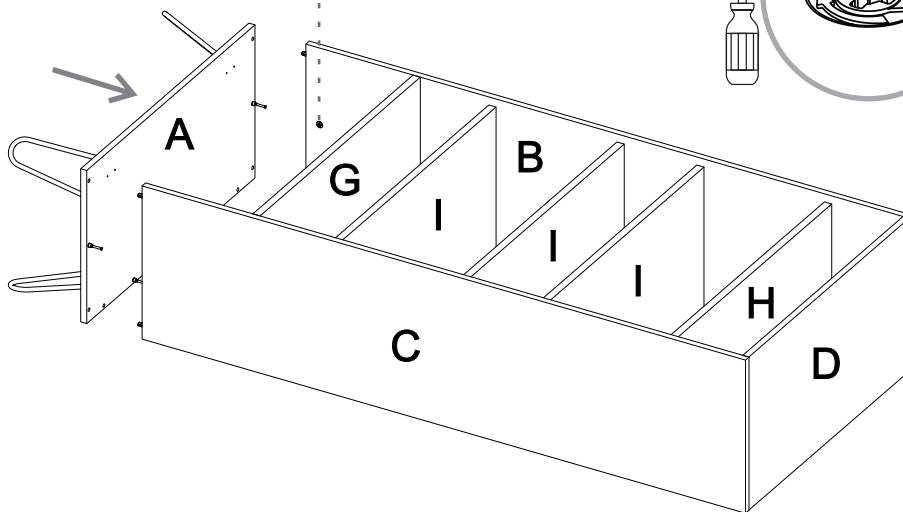
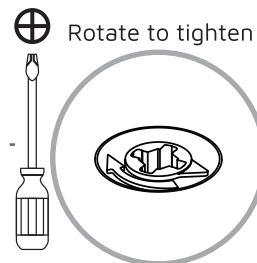

15

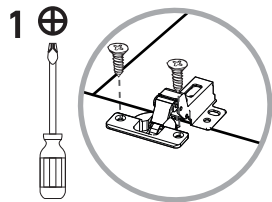

Hinge Adjustment

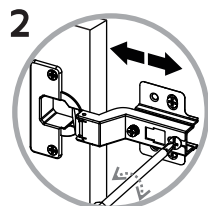

Depth Adjustment

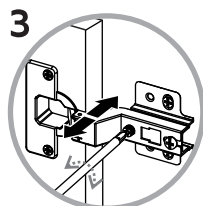

Side Adjustment

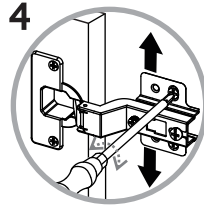

Height Adjustment

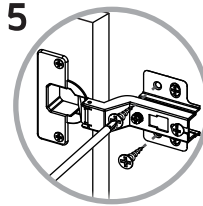

Secure Hinge

HANDLE ADJUSTMENT

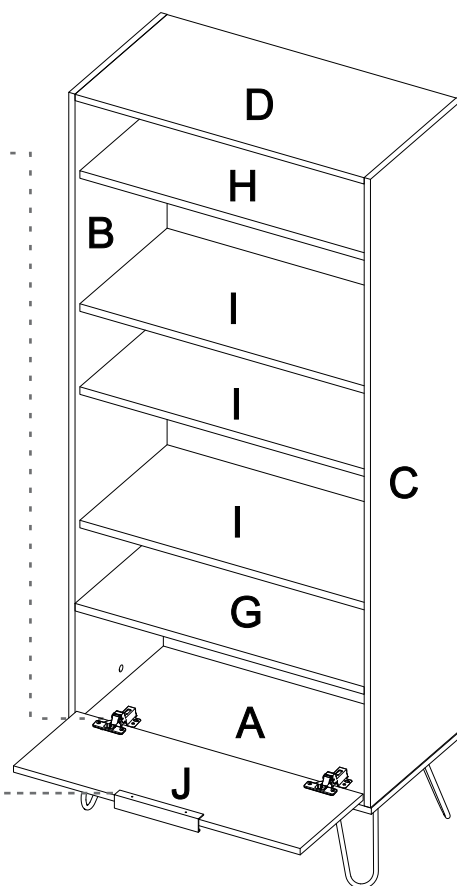
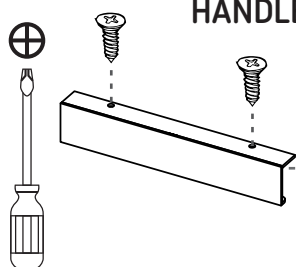

16

-WARNING! TIPPING HAZARD - Unanchored furniture can tip over
-WARNING: CHECK FOR HIDDEN PIPES AND CABLES BEFORE DRILLING.
-IMPORTANT: IF YOUR WALLS ARE NOT SOLID LIKE BRICK OR STONE, YOU WILL REQUIRE SPECIALIST FITTINGS (NOT SUPPLIED)

-Pre-drill small pilot hole on the back edge of the furniture top using a 2mm drill bit. Attach the other end of the fixing strip to the back edge of the furniture top using the 15mm screw + washer and securely tighten.

-Place fixing strip against the wall and mark position for drilling hole.

-Drill hole in your wall to a depth of 30mm using a 6mm drill bit. If the surface of your wall is soft and crumbly, we would advise you to use a 5mm drill bit for a tighter fit.

-Insert plug into hole with end flush to the wall surface.

-Attach fixing strip to the wall using the 25mm screw + washer and securely tighten.

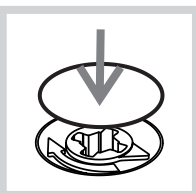
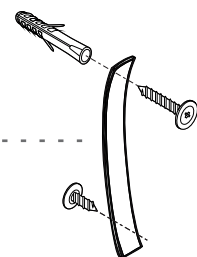
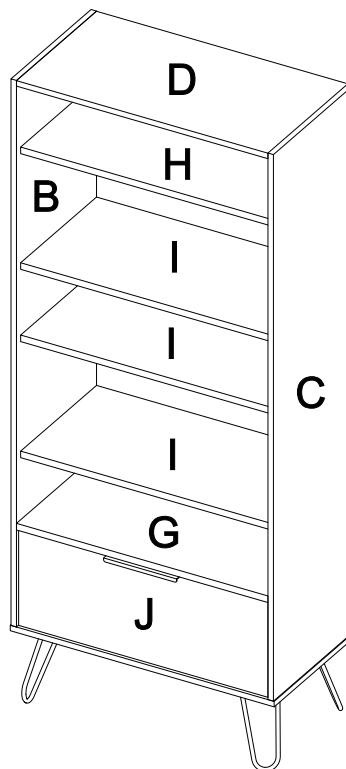

After you finish the adjustment of the cams, cover them with the cover caps.

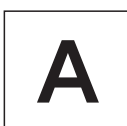

After you finish assembling the cabinet, take off the adhesive letters.