

Important information for your wood panel cabin

We are pleased that you have chosen a product of SKAN HOLZ.

Please check the construction set for completeness using the position list in good time before starting construction or commissioning your construction team. If individual parts are defective or missing, we will deliver these as quickly as possible. However, we cannot refund the costs for any resulting construction delays to a construction company.

Please understand that we cannot assume any guarantee for the following defects:

- incorrect storage before assembly
- incorrect anchoring with the ground or inadequate foundation (foundation according to statics)
- damage due to erection errors, e. g. the house is not level or not right-angled
- damage through a higher level of snow burden than statically envisaged. Recommendation: load relief of the roof by removing the snow layer
- storm damage (insurance cases) or violent destruction
- damage through any alteration to the design by the client
- natural formation of cracks, branch holes, twisting, decolouration or similar modification (natural process; has no influence on the statics)

Storage information until construction:

- store pallet on a level and dry surface.
- Protect from exposure to sunlight and the influences of weather; wood can warp drastically in a loose condition!







Maintenance tips:



The wood is untreated. Accordingly, regular, protective coating is absolutely necessary! Please observe the attached information sheet "Care instructions/Colour treatment".

General tips and refers to:



-  1 - The packaging foil **can be used** to keep moisture out of the house. It is laid according to the ground area of the house under the main bearing.
-  2 - Given that the roof is constantly exposed to the weather, a covering with only one layer of roofing paper will not be enough over the long-term. An additional covering with bitumen shingles, alternatively with a material of at least equivalent quality, must follow.
-  1 - **Foundation according to the structural calculations** (not included in the scope of delivery): concrete C25/30, each 2 Ø 12 top and bottom, brace mat R188A (alternatively brace Ø 6/20cm). Anchoring of the floor beams **(in the building)** on the strip foundation using bolts M12, e ≤ 60cm. The base bearings in the storeroom of the house must be entirely flush.
-  2 - The thread rods to secure the house against storm are secured at the top with a washer and a nut, from below with a washer, spring and nut to tighten the upper nut of the thread rod without any problem, the spring at the bottom should be pressed upwards with the thread rod. **The spring may only be tightened slightly** so that the house can work at the top. The **projecting ends of the thread rods have to be cut off at the top**. Even after the house has been completed, attention must always be paid to the fact that the thread rods are not seated on the floor as otherwise when it is dry, gaps can arise and the roof is pressed upwards. **Tip:** the thread rods can also be pushed subsequently into the bores. You have to make sure that **each plank has a bore** and that these are free and **not blocked by shavings or similar**.
-  3 - In case of varying weather conditions, the wood alters in height (due to 'working'). To avoid the formation of joints, the planks of the house may not, for example, be joined **to one another through several block planks** as then the wood can no longer expand.
-  4 - The **door and window frames may not be bolted to the wall above the first supporting plank** since the individual bolts will work in height. If the door does not close correctly, this can be readjusted by **rotating the hinges** in the door leaf and door frames.

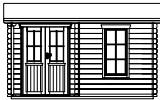

Garden Office 400 x 300cm



2

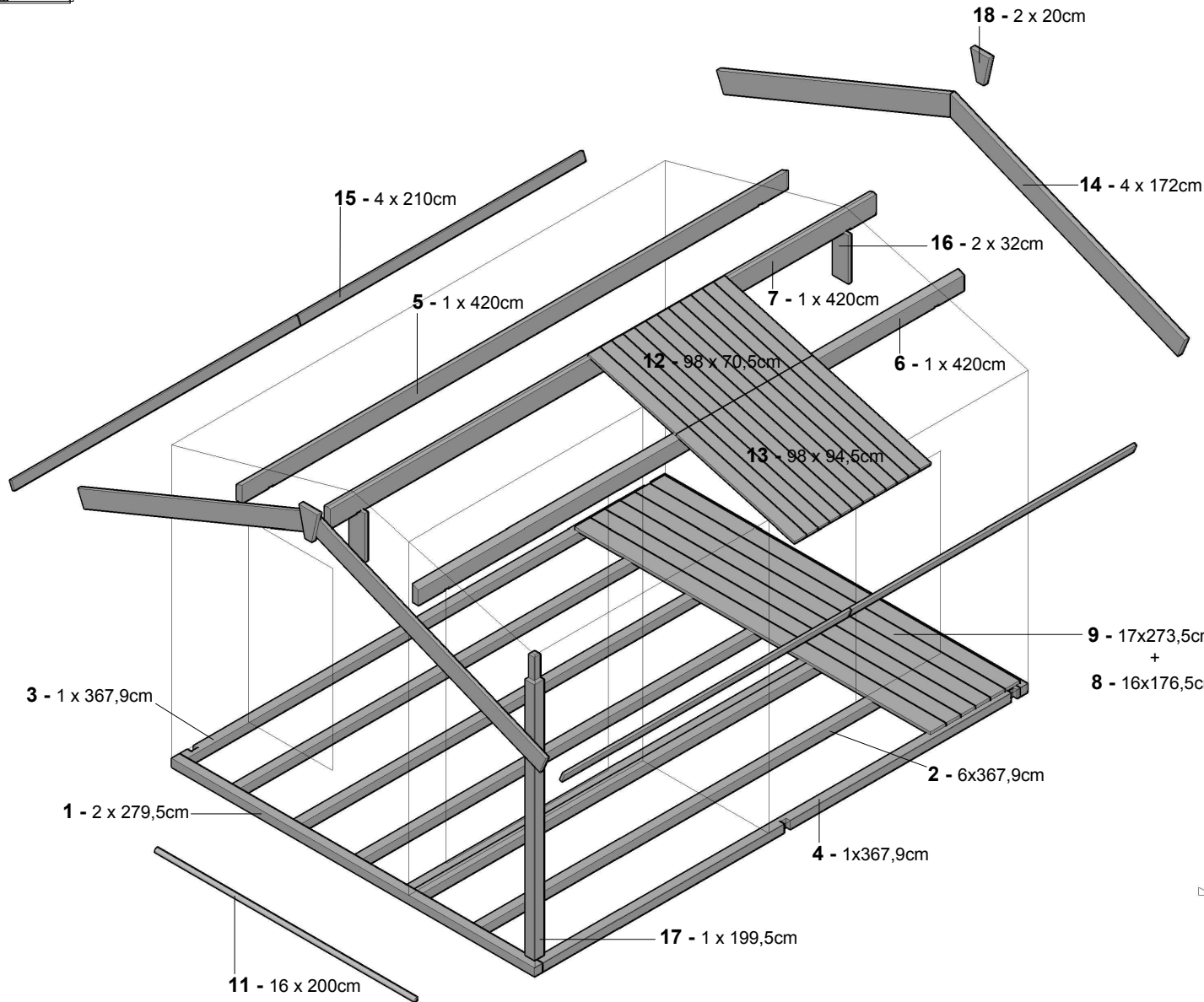

2 x B100-L



8 x B100



390 x B115-050 50mm

60 x B105-030 30mm

660 x B105-040 40mm

230 x B105-050 50mm

10 x B105-060 60mm

15 x B105-080 80mm

30 x B105-100 100mm

4 x B430-220

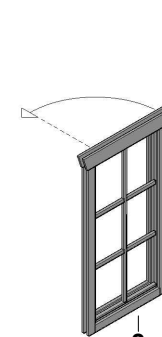

2 x 28-SW-R

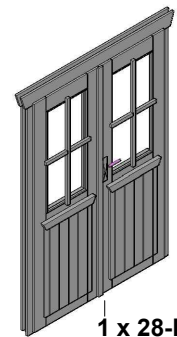

1 x 28-DD



Garden Office 400 x 300cm

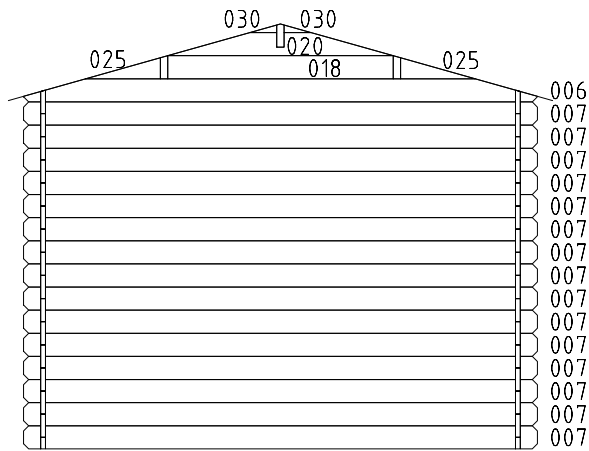
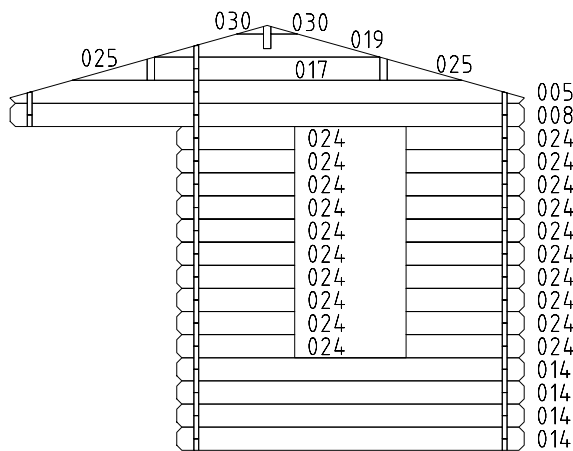
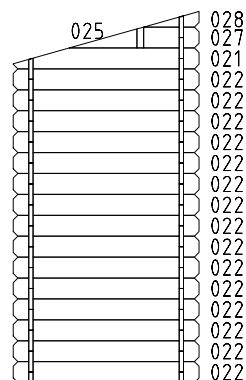
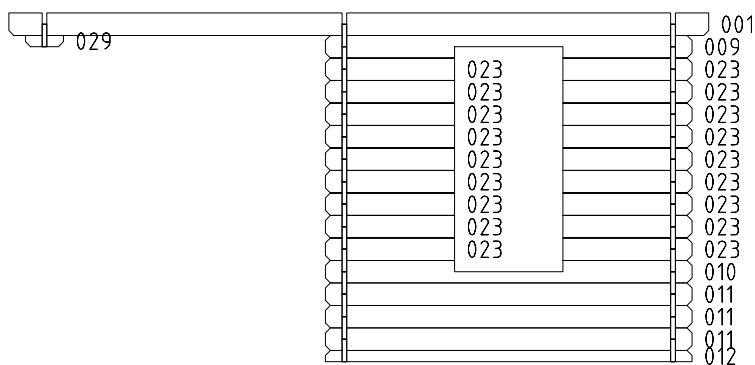
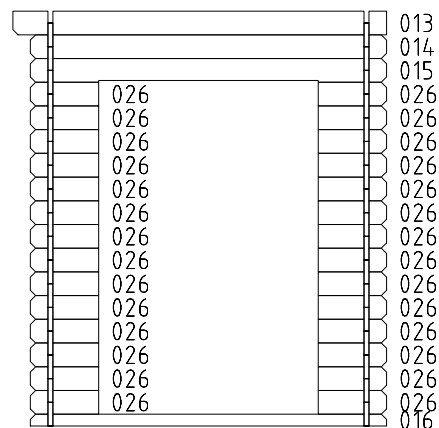
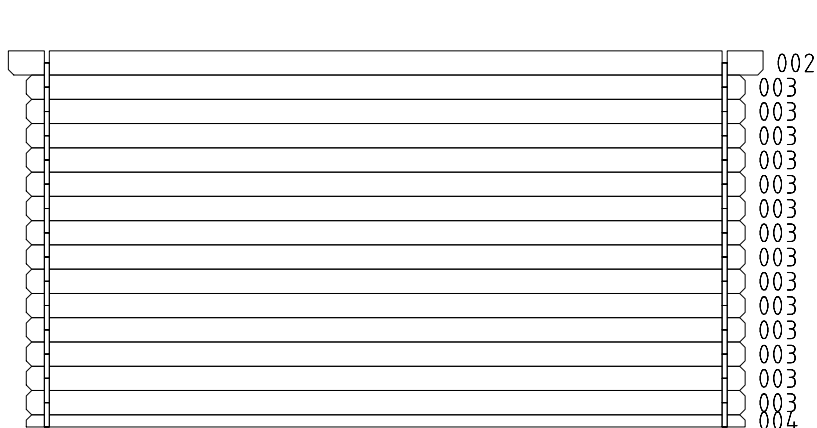

Zusätzlich / Adicional:

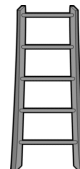
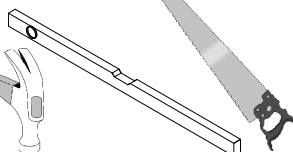
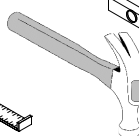
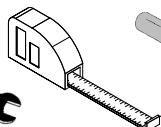
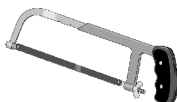



Garden Office 400 x 300cm



4

1

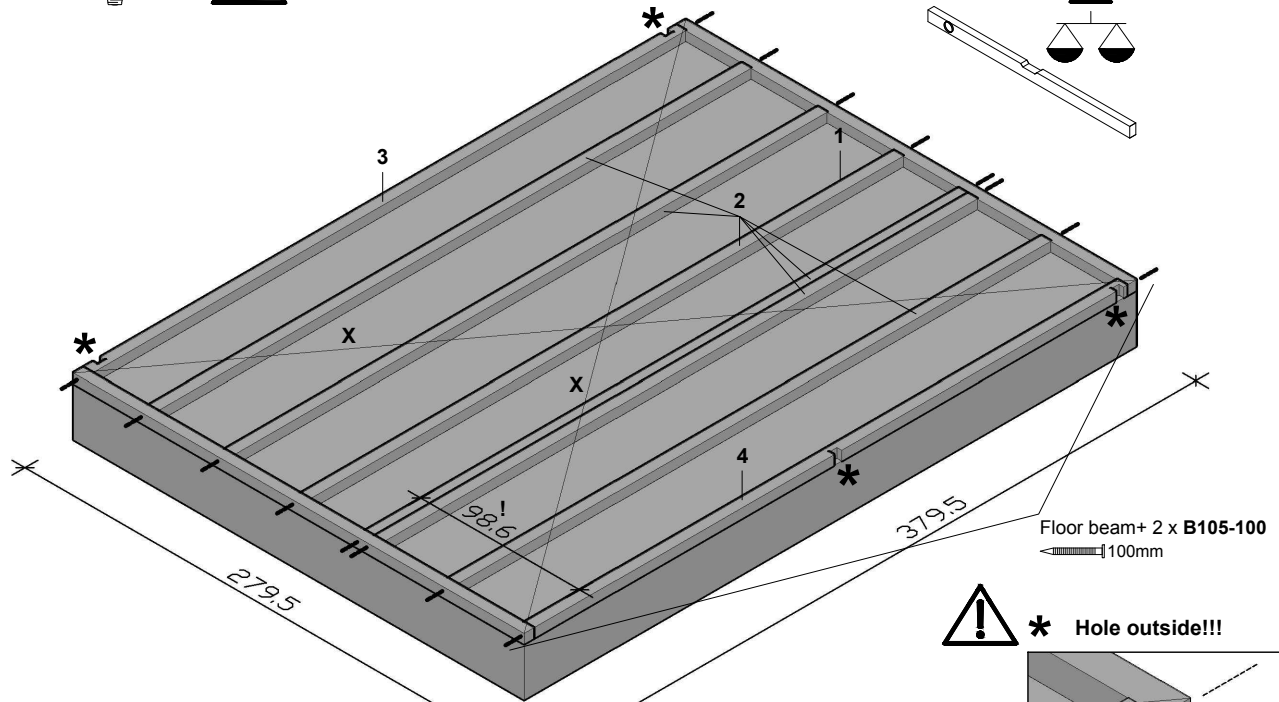

!!! X=X



* Hole outside!!!

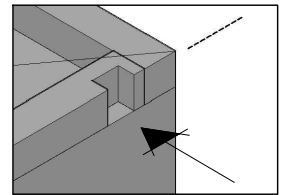

2

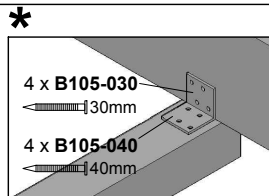

2.1

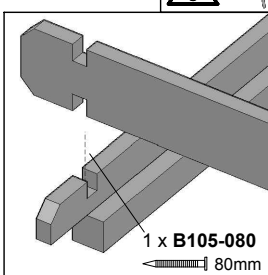

B430-220

2.1

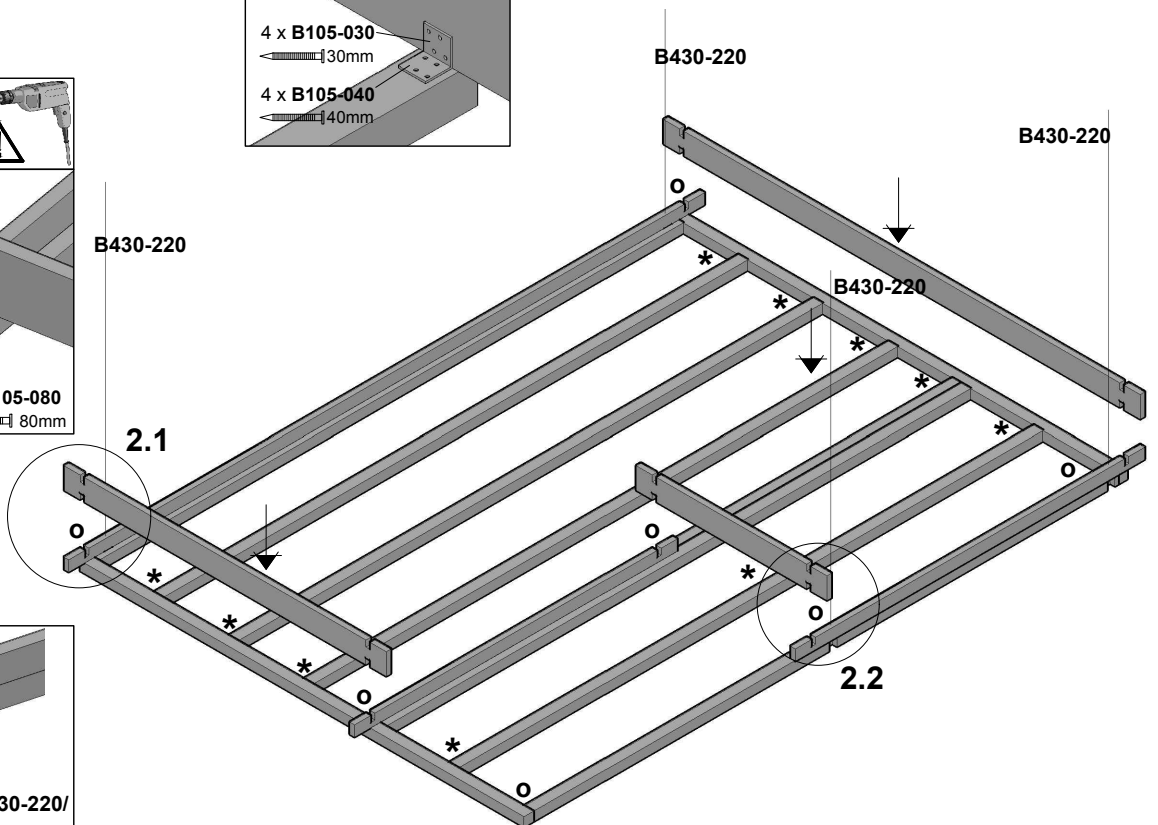

2.2

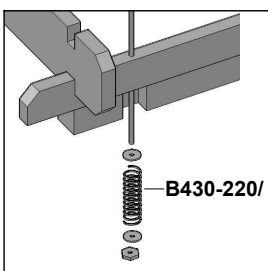

B430-220/

2.2



Garden Office 400 x 300cm



5

3

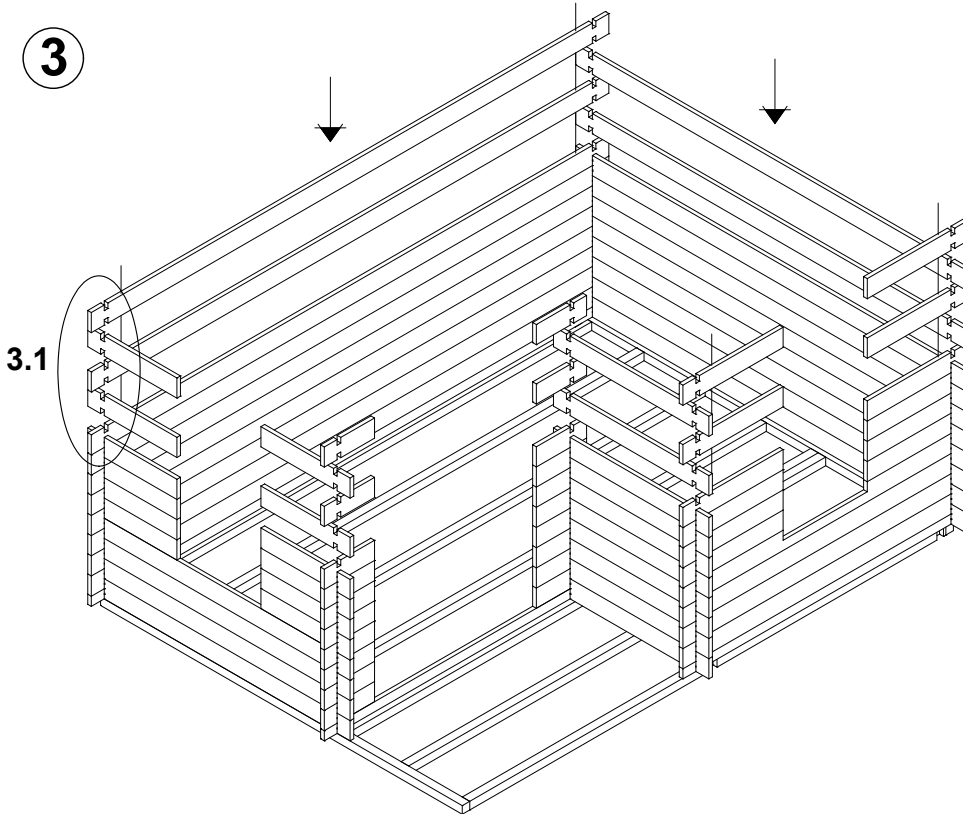

3.1

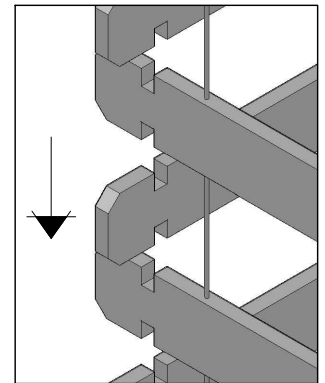

4

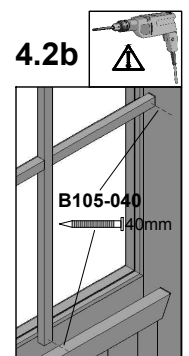
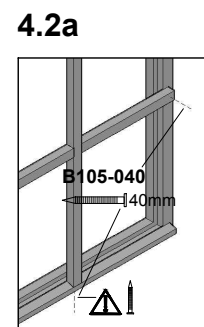
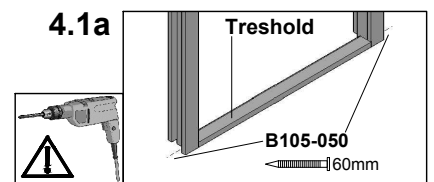
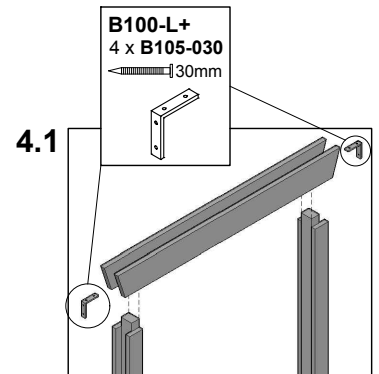
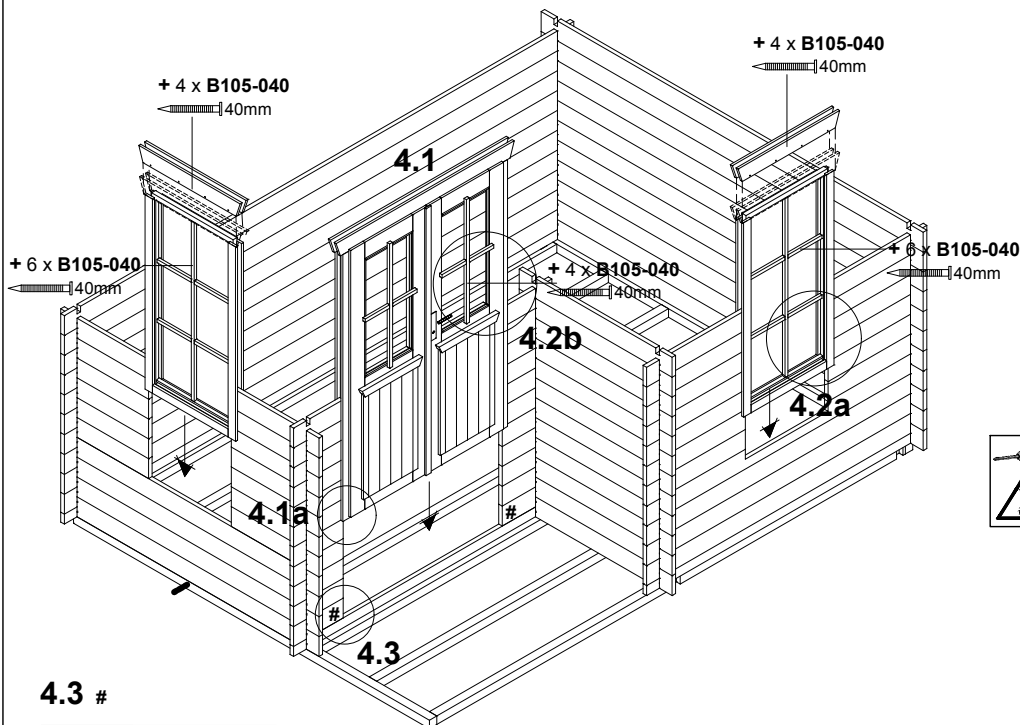
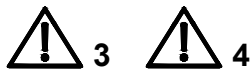

4.3 #

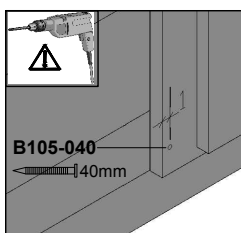

⚠ - inside and outside



Garden Office 400 x 300cm



5

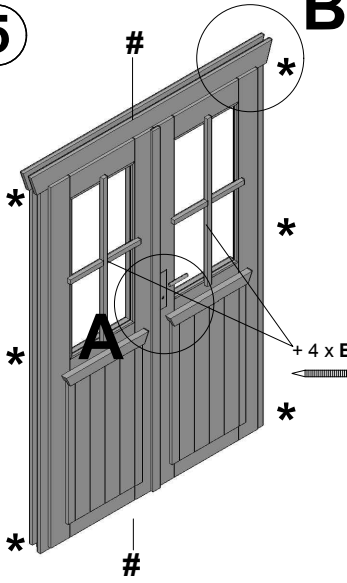

+ 4 x B105-040
40mm

A

B

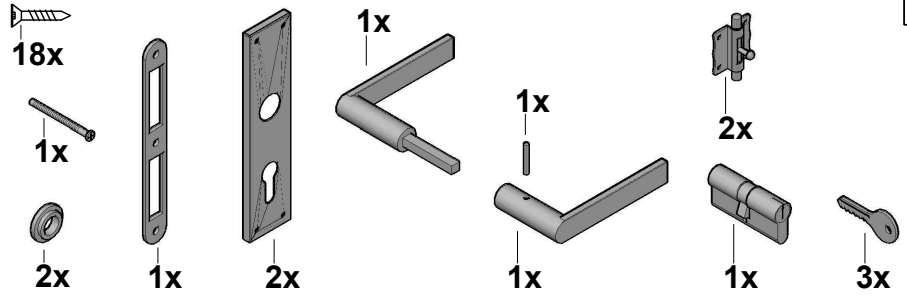

6

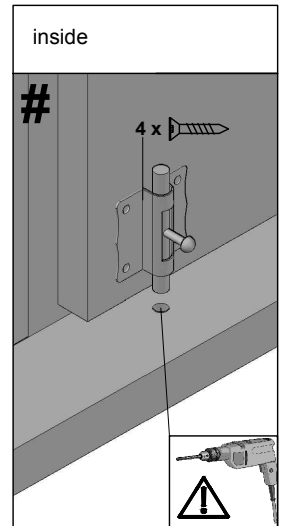
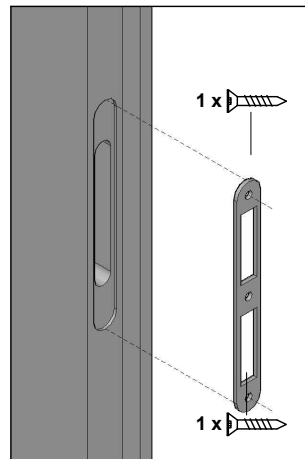
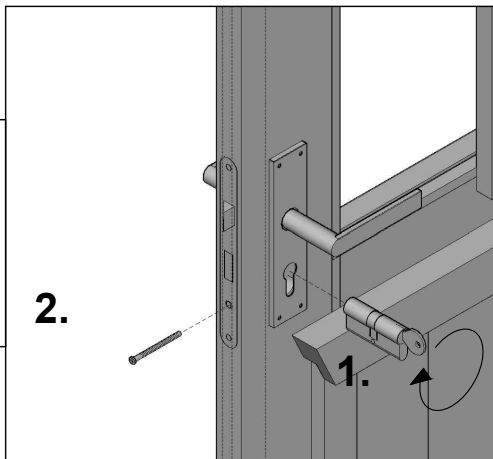
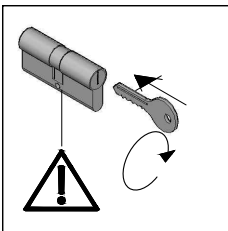
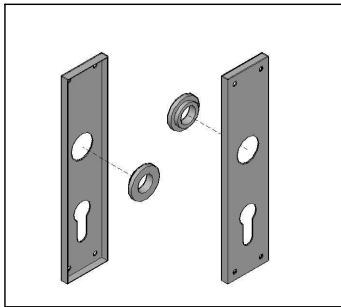
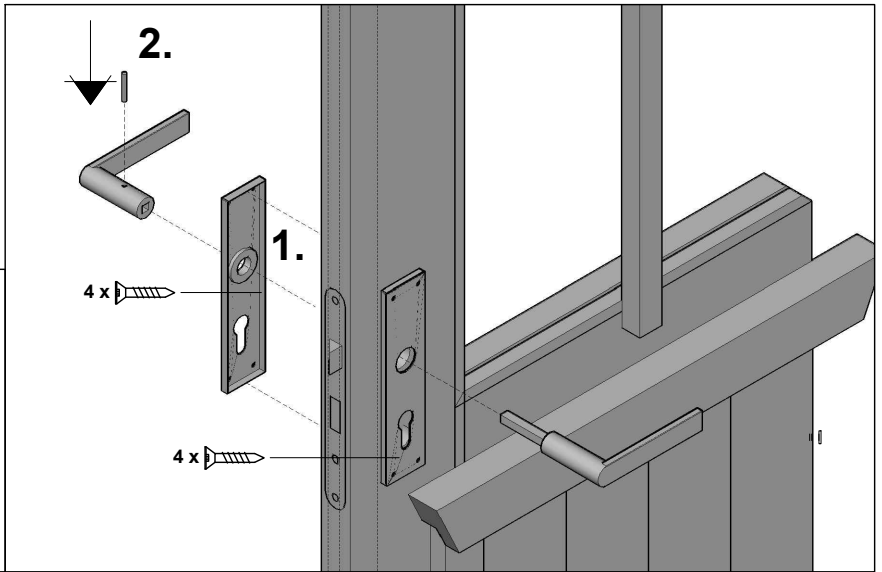

B

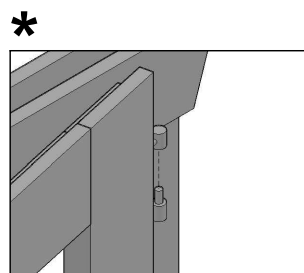

2

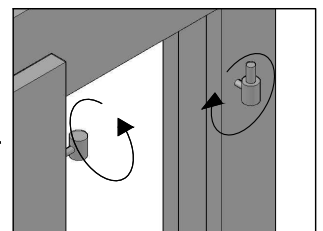



Garden Office 400 x 300cm



604210

7

5

5.2

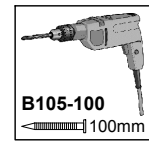
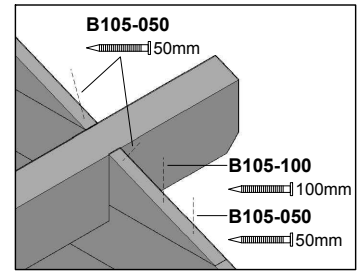

5.3

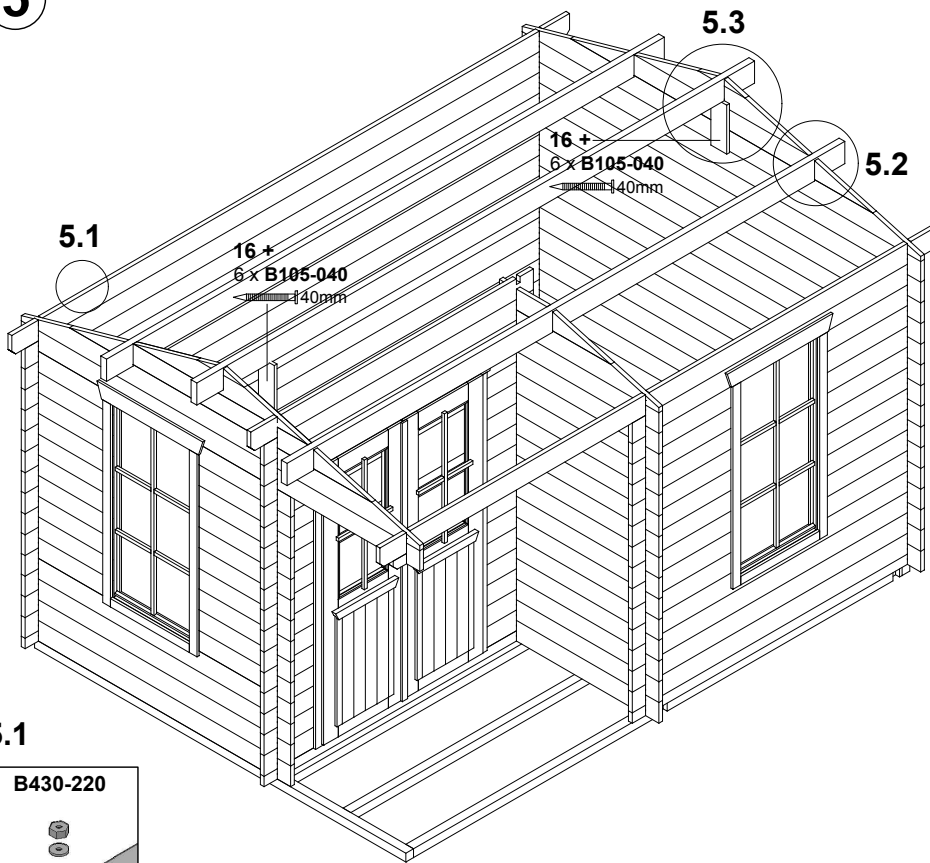
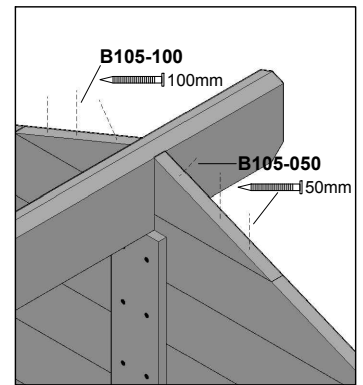

5.1

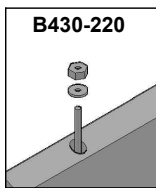

6

12 +
2 x B105-040
← 40mm

13 +
2 x B105-040
← 40mm

6.1

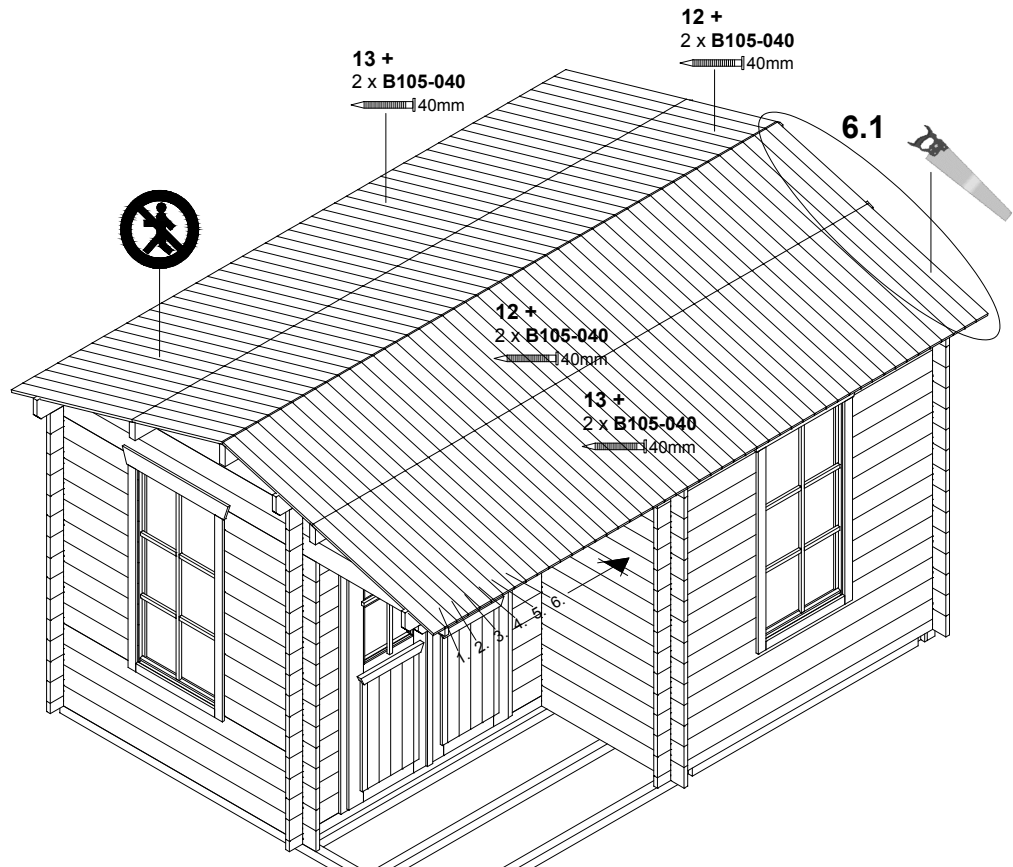

6.1

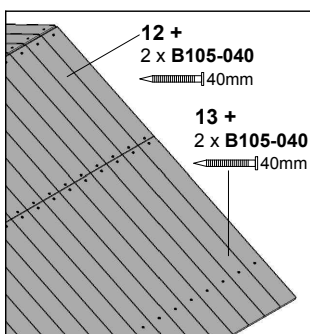



Garden Office 400 x 300cm



8

7

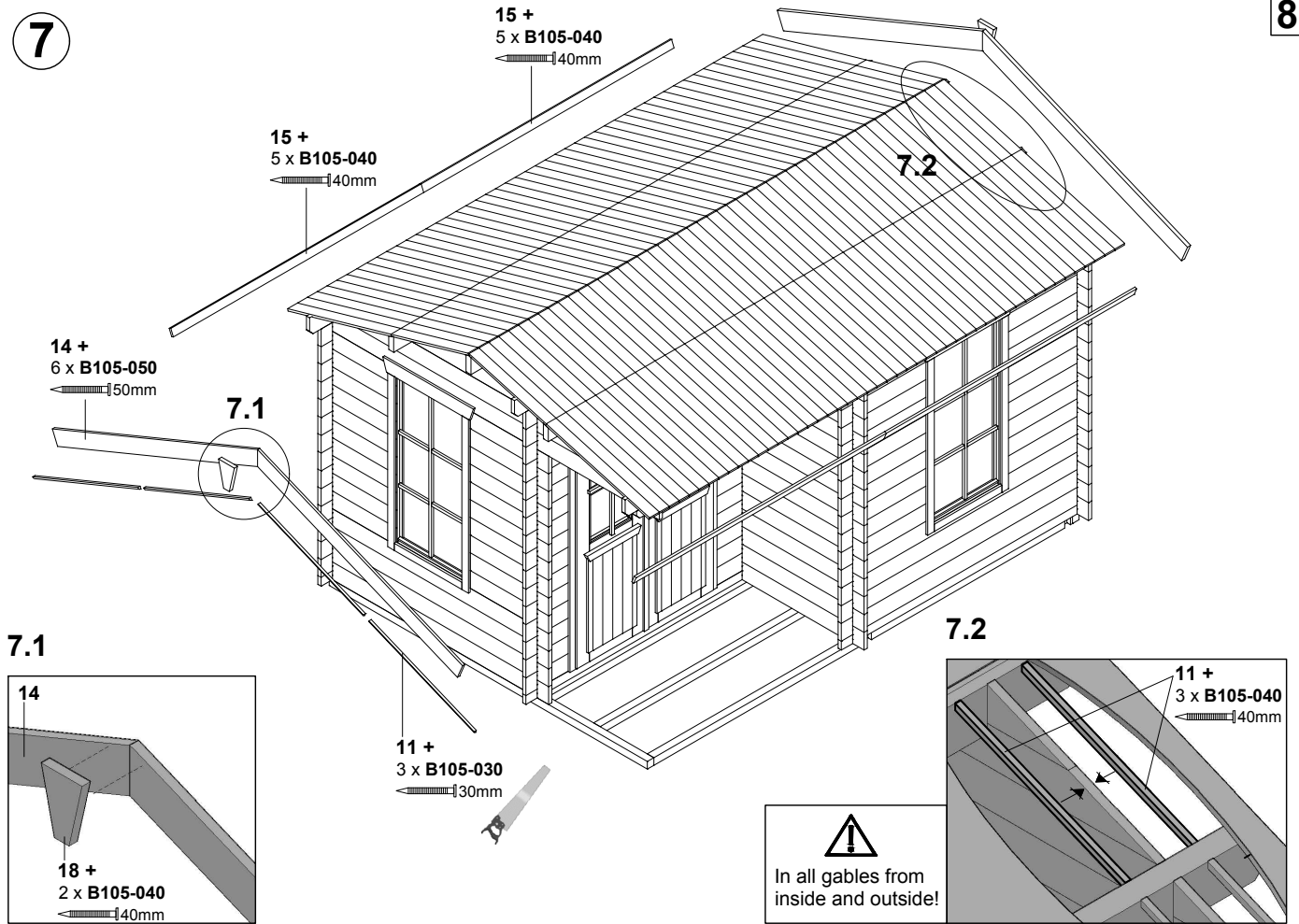

7.1

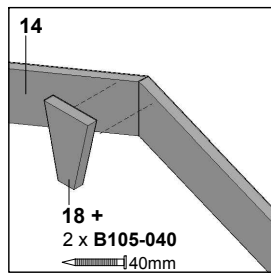

7.2

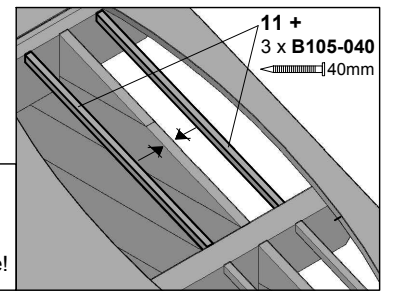

8

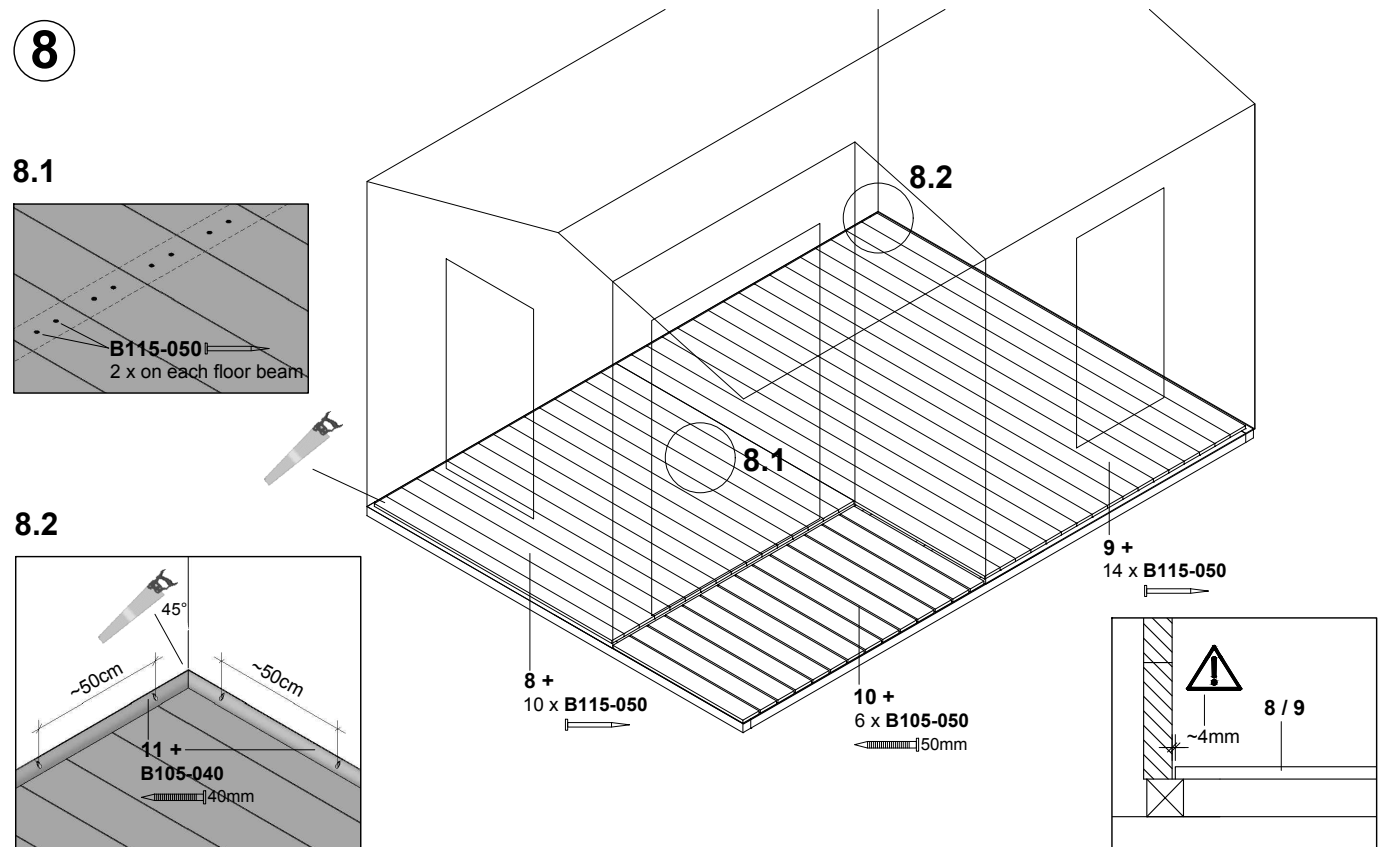

8.1

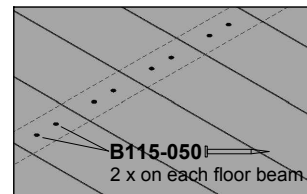

8.2

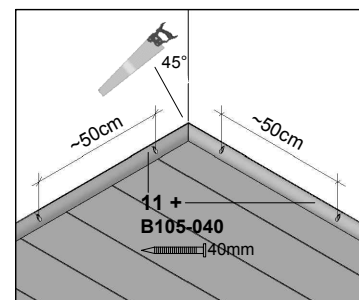



9

9

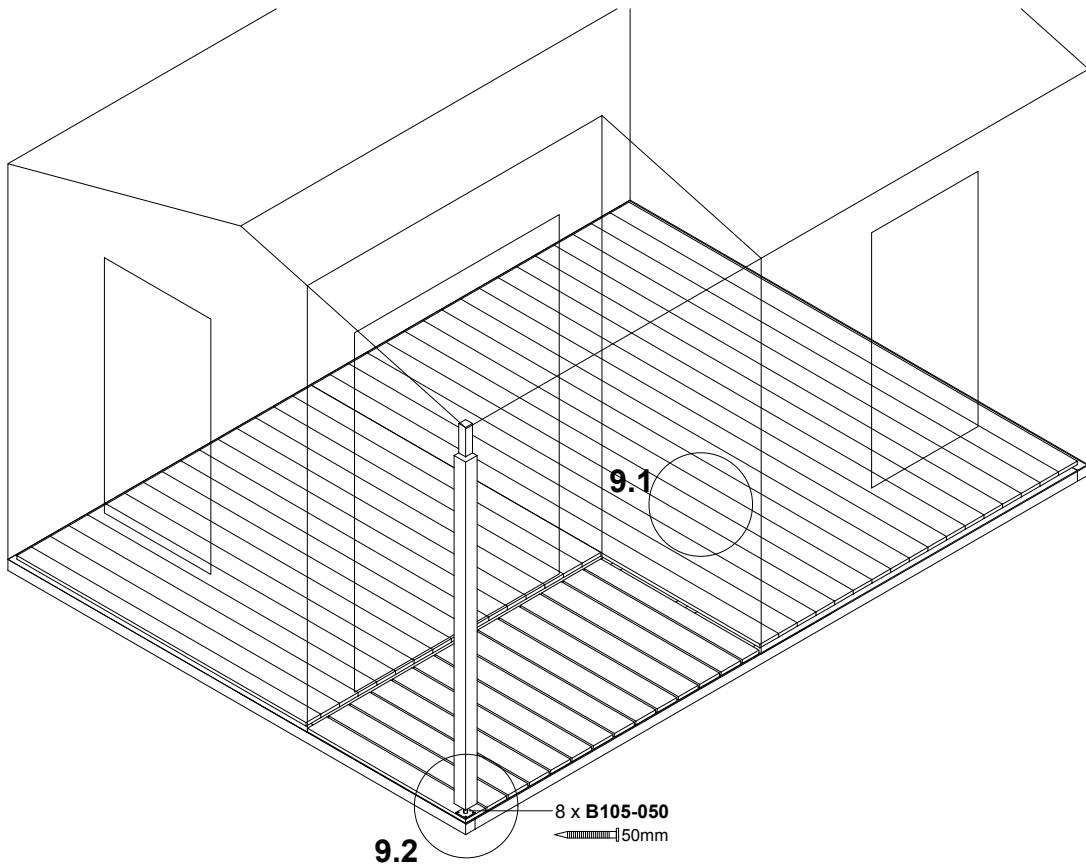

9.1

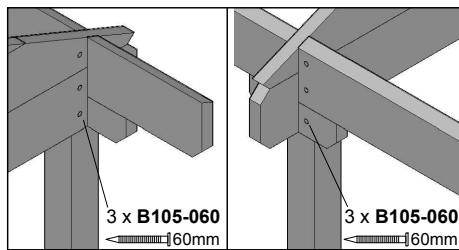





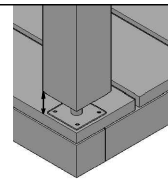









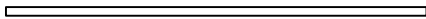

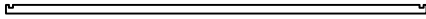







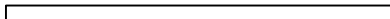











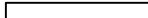

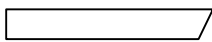
9.2

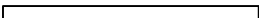
- Place bottom part on terrace boards
- drill hole in the bottom of post O 20mm
- place top part on post
- min 5cm between floor and post
- cut post shorter if necessary



Pos	Garden Office 400x300cm		Qnt	Dimens. (mm)	Length (mm)	Packed
001			1	28x135	4200	
002			1	28x135	4200	
003			14	28x135	4000	
004			1	28x68	4000	
005			1	28x135	3000	
006			1	28x135	3000	
007			15	28x135	3000	
008			1	28x135	3000	
009			1	28x135	2200	
010			1	28x135	2200	
011			3	28x135	2200	
012			1	28x68	2200	
013			1	28x135	2128	
014			5	28x135	2028	
015			1	28x135	2028	
016			1	28x68	2028	
017			1	28x135	1316	
018			1	28x135	1316	
019			1	28x135	1316	
020			1	28x135	1316	
021			1	28x135	1200	
022			15	28x135	1200	
023			18	28x135	775	
024			20	28x135	689	
025			5	28x123	437	
026			28	28x135	389	
027			1	28x135	358	
028			1	28x101	358	
029			1	28x68	228	
030			4	28x44	156	

Packed:

Pos	Garden Office 400x300cm			Qnt	Dimens. (mm)	Length (mm)	Packed
	WINDOW 640x1300			2			
	DOUBLE DOOR 1242x1850+ door treshold 20x46x1176mm			1			
1		Floor beams		2	58x58	2795	
2		Floor beams		6	58x58	3679	
3		Floor beam		1	58x58	3679	
4		Floor beam		1	58x58	3679	
5	 □	Roof beams, left		1	43x120	4200	
6	 □	Roof beams, right		1	43x120	4200	
7	 □	Roof beam, top		1	43x120	4200	
8		Floor boards		16	19x121	1765	
9		Floor boards		17	19x121	2735	
10		Terrace boards, impregnated		15	19x120	965	
11		Floor/gable slats		16	20x20	2000	
12		Roof board		98	16x95	705	
13		Roof board		98	16x95	945	
14		Gable slat		4	19x120	1720	
15		Eaves slat		4	16x38	2100	
16		Gable slat		2	19x120	320	
17		Post for terrace		1	70x70	1995	
18		Gable decoration piece		2	20x120	200	
	Steel bars			4	6 mm	2200	
	Bolt down post support			1	60x60		
	Fittings set			1			

Packed: